

A large, light green, stylized number '2' is positioned on the left side of the page, partially overlapping the text. It has a thick, rounded font style.

TEMA 2

Načrtovanje konstrukcij in  
vzdrževanje podzemnih prostorov

---

TOPIC 2

Design and Maintenance  
of Underground Structures

## 7. mednarodno posvetovanje o gradnji predorov in podzemnih prostorov

TEMA 2 | NAČRTOVANJE KONSTRUKCIJ IN VZDRŽEVANJE PODZEMNIH PROSTOROV

## The Gotthard Base Tunnel: Project Overview

Andreas Henke, Director, dipl. Ing. ETH/SIA  
Davide Fabbri, chief designer, dipl. Ing. ETH/SIA  
Engineering joint-venture Gotthard Base Tunnel South  
(Lombardi Engineering, Amberg Engineering, Electrowatt Infra)

### Abstract

The Gotthard-Base Tunnel will be the worlds longest traffic tunnel, with a length of 57 km. The tunnel is part of the New Alpine Transverse in Switzerland. The dual purpose of this project is to provide a highspeed link for passengers between Germany in the North of Europe and Italy in the South of Europe and to transfer freight traffic from roads to rail. It makes an essential step to actively protect the Alps and to get an important contribution to preserve the environment in general. At the present time the construction works are proceeding ahead at both portals and at the three intermediate accesses. Over 33% of the total length of tunnels and the galleries are excavated. Some difficult parts of the tunnel have been completed successfully, some others with over 2,000 m of overburden and poor rock mass properties have to be excavated next.

### Introduction

The transalpine rail routes through Switzerland are more than a hundred years old. As they no longer meet the requirements of ever-increasing rail-traffic between north and south they are now being rebuilt. The actual Gotthard rail route is in facts a mountain railway: the northern and the southern access ramps – with a maximum speed of 80 km/h and with a maximum decline of up to 2.2% climbs up to about 1,100 m a.s.l., where the old Gotthard rail tunnel is located, approximately 900 m higher as the city of Milan.

The Swiss government has decided to create these new alpine Transverse with two rail lines. The Swiss population did confirm this decision and with his vote gave the required authorisation to deliberate the money for this important investment.

The Swiss federal railways together with the Lötschberg railways were commissioned for the realisation and the management of the two New Alpine Transverse, Gotthard and Lötschberg. The AlpTransit Gotthard Ltd., founded by Swiss federal railways – with headquarter in the heart of Switzerland in Lucerne – were charged to manage the design and the construction works of the Gotthard route until the begin of the regular service of the new flat railway.

### General aspects of the new Gotthard route

The transalpine rail route “Gotthard” will rely the city of Zurich with the city of Milan (see Fig. 1), interesting a catchment’s area of over 20 millions people in Germany, Switzerland and Italy. Shorter travelling times – an hour less between Zurich and Milan, for example – will mean that rail travel across the Alps will be able to compete with flying (a better modal split for the rail) and to permit to optimise connections.

The realisation of three important tunnels is required: the Ceneri Base Tunnel in the southern part (15 km long), the Zimmerberg Base Tunnel in the northern section (total length 20 km) and the Gotthard Base Tunnel in the heart of the project (57 km).

## 7. mednarodno posvetovanje o gradnji predorov in podzemnih prostorov

### TEMA 2 | NAČRTOVANJE KONSTRUKCIJ IN VZDRŽEVANJE PODZEMNIH PROSTOROV

Fig. 1: New transalpine rail routes through Switzerland.



The most impressive part of the new traffic route through the Alps is the Base tunnel under the Gotthard, which is planned to handle mixed traffic, that is high speed passenger trains (up to 250 km/h) as well as slower freight trains (up to 160 km/h). Once complete and operating, the Gotthard base tunnel will be the longest tunnel in the world. It will run through the Alps at approx. 500-550 meters above sea level. It's highest overburden will be approx. 2,300 m. With a minimum Radius in curves of 5,000 m and with a maximum slope of 0.70% the Gotthard base tunnel will be the first flat railway trough the Alps.

#### Overview of the Tunnel Design

The base tunnel stretches from Erstfeld in the north to Bodio in the south (see Fig. 2). It consists of two parallel single-track tubes with a diameter varying from 9.0 up to 9.5, which are linked by crosspassages every 300 meters. At two positions, one-third and two-thirds along the base tunnel, are located multifunction stations for the diversion of trains via the crossovers to the other tube, for the installation of electro-mechanical installations, and for the stop of trains and the evacuation of passengers in an emergency case.

Fig. 2: Scheme of the tunnel system.

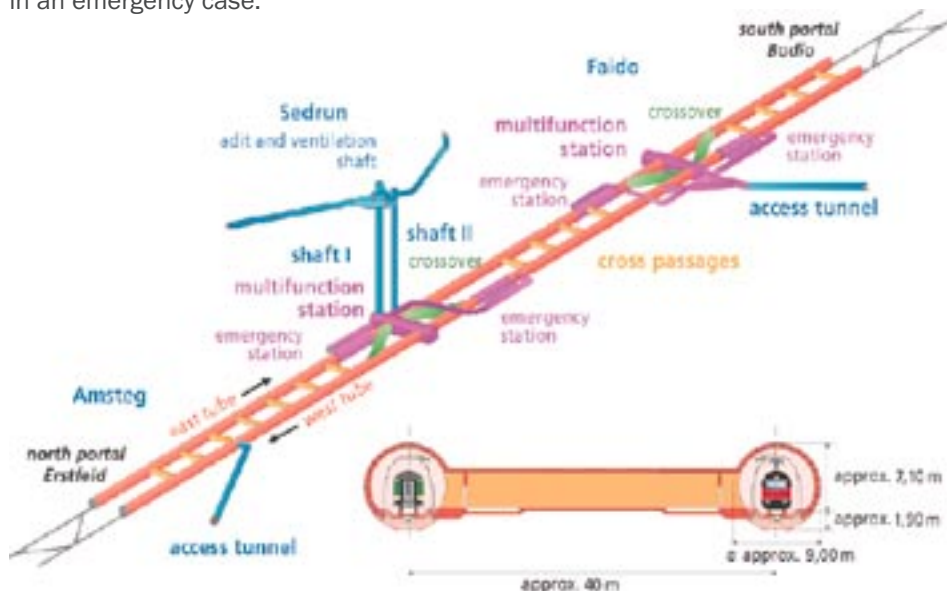

Detailed and sophisticated evaluation demonstrated that this tunnel system was the most suitable for long alpine tunnels. To shorten construction time and for ventilation purposes, the tunnel will be driven from several sites simultaneously. To this end, the tunnel has been divided into five sections. Excavation will take place from the portals as well as from three intermediate attacks in Amsteg, Sedrun and Faido.

**The Geology / Geological conditions**

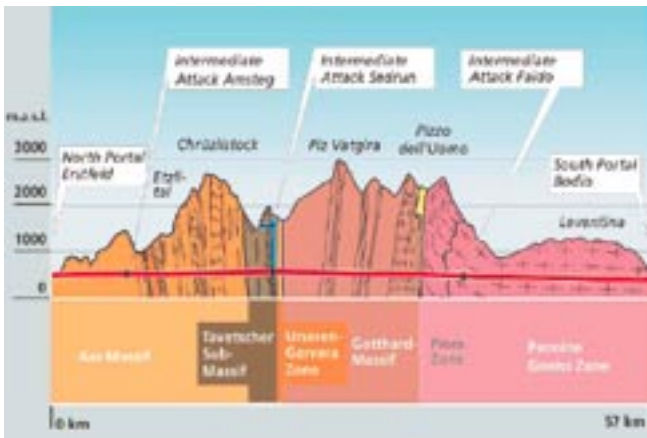

Fig. 3: Geology of the Gotthard Base Tunnel.

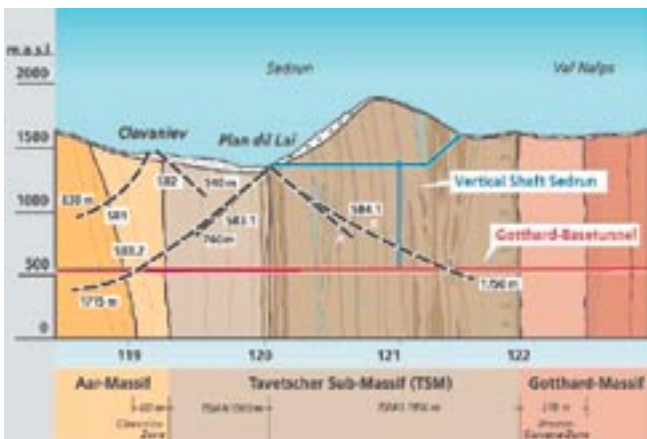

Fig. 4: Investigations in the Sedrun section.

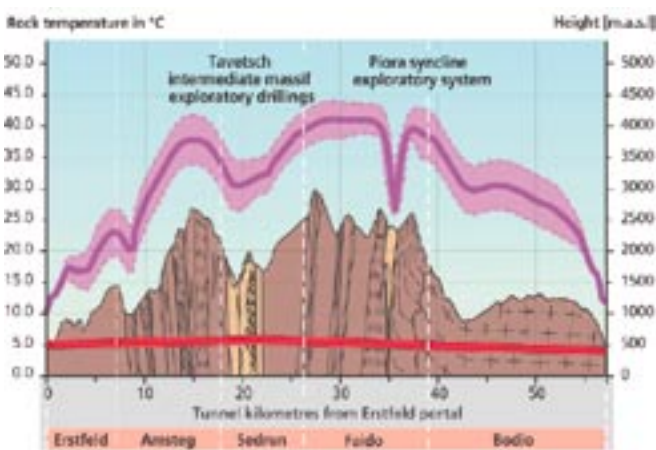

Fig. 5: Forecast rock temperatures at base tunnel level.

From north to south, the 57 km long Gotthard Base Tunnel passes through mostly crystalline rock, the massifs which are broken by narrow sedimentary zones, the tectonic zones. The 3 crystalline rock sections are the Aar-massif in the north, the Gotthard massif in the middle and the Pennine gneiss zone in the south (see Fig. 3). These zones are unlikely to cause any major technical difficulties during construction and they are quite favourable for tunnelling. These units consist mainly of very strong igneous and metamorphic rock with high strength. More than 90% of the total tunnel length consists of this type of rock. The main danger is the risk of rock burst caused by the high overburden, the instability of rock wedges and water inflow.

Major sections of the tunnel will have a very high overburden: more than 1,000 m for roughly 30 km, more than 1,500 m over 20 km and it can even be more than 2,000 m for approx. 5 km, the maximum is about 2,300 m. This has been taken into consideration in deciding the heading concept and rock support design.

The most difficult section facing the new tunnel is the so called (old crystalline) Tavetsch intermediate sub-massif in the Sedrun section. Located between the Aar-massif and the Gotthard-massif, it is one of the about 90 different isolated short fault zones along the 57 km. It consists of a steeply-inclined, sandwich-like sequence of soft and hard rock. Exploratory drilling in the early nineties indicated extremely difficult rock conditions for about 1,100 m of the tunnel (see Fig. 4). As well as compact gneiss, there are also intensively overlapping strata of schistose rock and phyllite.

In the Faido section the Piora syncline has been deeply investigated in the second part of the nineties.

The initial planning phases concentrated on cutting through the different fractured zones at their narrowest points wherever possible. The high mountain overburden of up to 2,300 m means that operating temperatures in the tunnel can reach 35-40°C (see Fig. 5). In order to maintain the required air conditions in the different working areas, a continuous cooling system is required.

### Current state of Construction works

Work on the Gotthard Base tunnel has been proceeding for many years, e.g. in Sedrun work has been in progress since 1996. On July 19<sup>th</sup> 2004 the first milestone at the northern portal Erstfeld, the starting point of the last section, has been set and in the next months preparations will proceed for the main work on the tunnel. Now in all construction sites (portals and intermediate attacks) the base tunnel is under construction. Up to the present, about 50.4 km of tunnels and galleries or 33% of the entire project (153.3 km) have been excavated. These are shown in red and green on the 3-dimensional picture in Fig. 6.

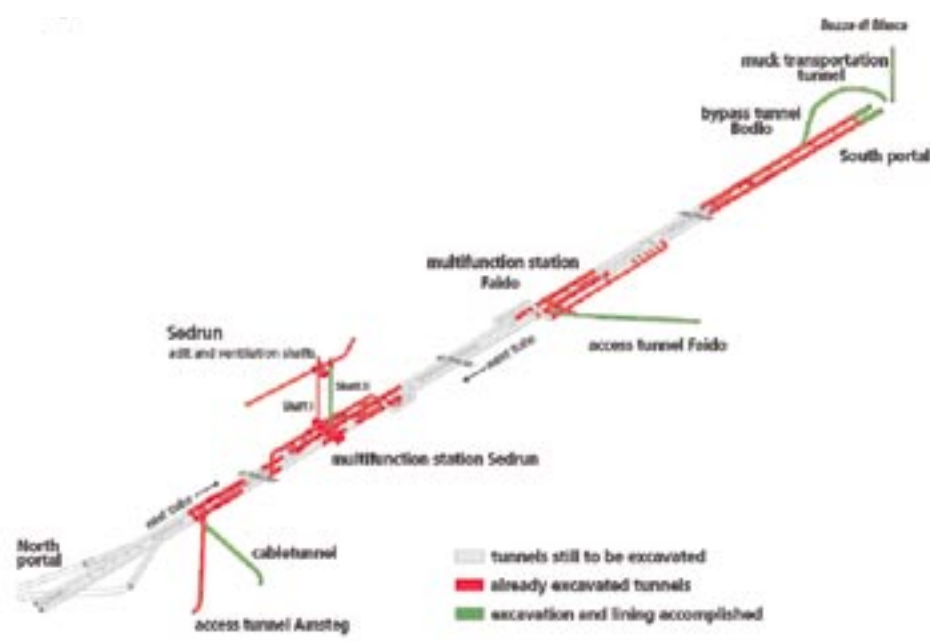

Fig. 6: Gotthard base tunnel, state of works on July 14<sup>th</sup> 2004.

According to the progress made in the different sections, the actual overall time schedule shows that the excavation works of the tunnels will be finished in March 2010 and the first train will run through the Gotthard Base Tunnel in April 2015.

### Amsteg Section

In Amsteg, the heading of the 2 km long horizontal adit to the axis of the Base Tunnel began in December 1999, as did construction of the processing plant and all the conveyor belt equipment for the removal of the muck.

In autumn last year the two TBMs in the Amsteg section with a diameter of 9.58 meters each, were installed in underground installation chambers. More than 3.2 km in the west and 3.7 km in the eastern single track tube have been driven thus far. In April this year the first predicted geological difficult zone (the Intschi-zone) was penetrated successfully and without the suspected time delays.

The TBMs (see Fig. 7) still have more than 7 km each to go. The best performances up to July 31<sup>st</sup> 2004 are 40.10 m within a single day and 664.50 m within a single month; at the present time the daily average heading rate is of about 9.62 m (TBM west) respective to 9.06 m (TBM east). The debris is transported with conveyor belts from the back-up of the TBMs to the material processing plant on the construction



Fig. 7: Tunnel Amsteg, east tube, TBM cutter-head TBM.

site, where a part of it is recycled to produce concrete aggregates. Tunnel trains only provide transportation of rock support materials, concrete, miners and staff members, and sometimes visitors. The rest of the debris of the Amsteg and Erstfeld sections will be transported by rail and boat to the nearby Reuss river mouth, where it will be used for restoration of the natural conditions of the river delta.

### Sedrun Section

This section is the most complicated of the base tunnel, for logistical and geological reasons. The adit (1 km), the inclined ventilation shaft (450 m), the cavern at the top of the first shaft and the 835 m deep vertical access shaft have been completed in several preparatory construction lots. The entire logistic supply for the heading of a total tunnel length of 2 x 6.8 km (4 simultaneous tunnel drives, together with others minor drives) has to be done through the access tunnel and the double shaft system. Up to 6,000 tonnes of excavated material have to be handled every day. Shaft drives were installed for a double floor hoisting cage with a 5 MW rating, providing 60 km/h hoisting speed for an 80 t load.

Shaft 1, with a diameter of 7.90 m has been excavated in full section from the cavern at the shaft top by drilling and blasting. To sink shaft 2 -two extra caverns have been first excavated at the top and bottom level - in the phase 1 a pilot bore with a drilling bit of 43 cm has been realised from shaft top (daily heading rate 11.07 m). In second phase the pilot bore has been enlarged with a raise-boring machine to a diameter of 1.80 m (daily heading rate 25.83 m). In the third and last phase shaft 2 has been enlarged to the final diameter of 7.0 m with a shaft top down boring machine (daily heading rate 5.05 m). Phases: see Fig. 8.

Fig. 8: Shaft Sedrun, sink of shaft nr. 2

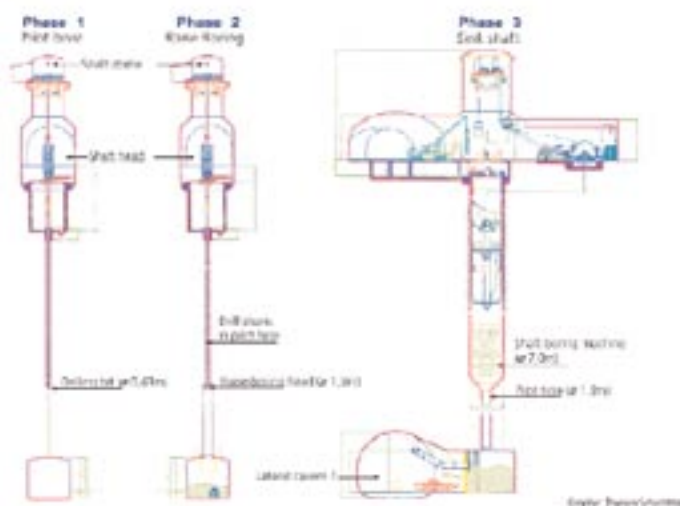

The headings are still going on in quite favourable geological conditions (better as the geological prediction, without radial deformations and dry water conditions). To the present, about 5.3 km of tunnels and galleries have been excavated.

However in autumn this year they will reach the phyllites and shales of the Tavetsch intermediate massive. In these very bad rock conditions, in consideration of over 2,000 m of overburden, it is expected to deal with radial deformations of up to 70 cm and a daily heading rate of about 80 cm. Intensive support with steel arches, anchoring and face support will be necessary. To check the ultimate resistance of yielding lining, tests in real scale

with a double steel ring TH44 – with simulation of rock mass pressures of about 0.75 MPa – have been undertaken (see Fig. 9). With a minimum distance between each double steel ring of only 0.33 m, the ultimate expected resistance of the support of the strongest cross section (including rock bolts) will be under a rock mass pressure of about 1.80 MPa. The cross section of the single tubes increases from about 80 square meters up to more than 130 square meters (see Fig. 10).



Fig. 9: Tunnel Sedrun, tests for yielding lining.

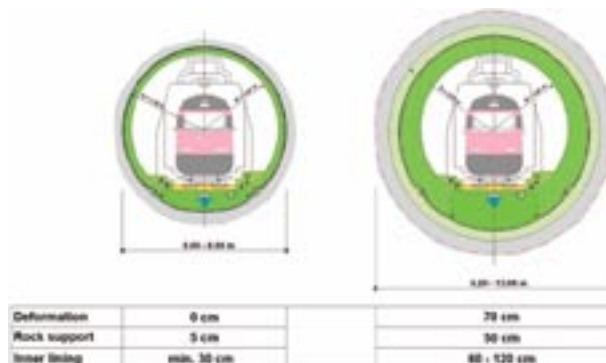

Fig. 10: Tunnel Sedrun, typical cross sections.

### Faido Section

In Faido the Base Tunnel is opened up via an inclined 2.7 km long access adit (decline of 12.7%). The construction of this gallery began in December 1999 and has been constructed by conventional drilling and blasting. Close to the adit portal, extensive processing plants – for recycling of a part of the muck and for the production of concrete aggregates – and conveyor belt systems for the transportation of debris have been constructed. A 5 km long conveyor belt takes part of the surplus debris to be deposited finally in an old quarry.

The contract for the main lot in combination with the southern Bodio section has been awarded at a sum of 1.1 billion US\$. The Multifunctional station was planned according to the geological prediction in favourable rock conditions. The different types of galleries, tunnels and caverns are excavated by drilling and blasting.

Totally unexpected, in summer 2002 an intensive fault zone has been met. It passes through the large caverns of the multifunctional station at a very acute angle. An intensive investigation program was carried out to define the best place for the huge cross over caverns with cross sections up to 260 square meters – mind that with an overburden of nearly 1,500 m. The picture in Fig. 11 gives an impression of the test drillings, investigation headings as well as the location and dimension of the fault zone (shown in red). As a result of these investigations it was possible to adapt the layout of the multifunctional station with the aim of placing the large caverns in good rock conditions in the southern part of the multifunctional station. To the present, about 6.7 km of tunnels and galleries and two cross over caverns have been successfully excavated.

Fig. 11: Multifunctional station Faido, investigation program and location of fault zone.

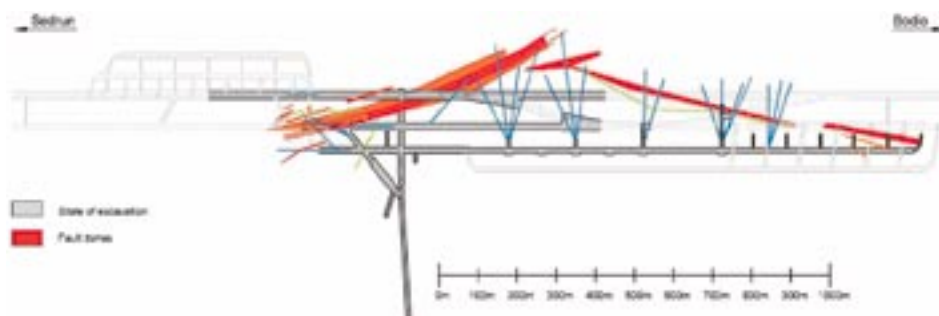



The northern headings in the single track tubes are still within the fault zone and still need very intensive rock support. The yielding steel support (see Fig. 12) has proved to be a good system in these rock conditions with more than 40 cm of radial deformations.

Fig. 12: Tunnel Faido, yielding lining.

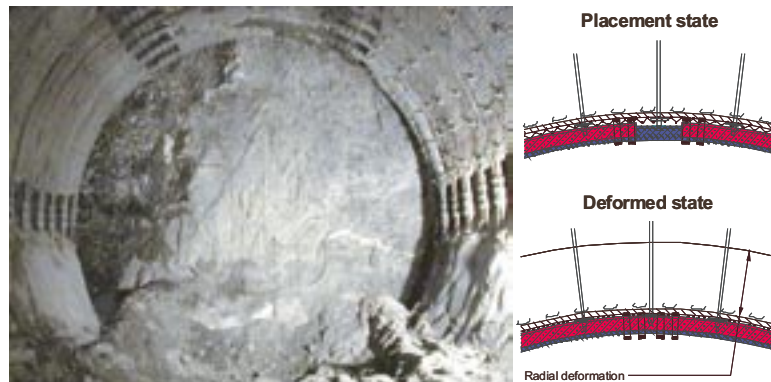

### Bodio Section

Extensive constructions work were taking place at the southern Portal in Bodio before Autumn 2002, in preparation for the heading of the main tunnel lot. These were:



Fig. 13: Tunnel Bodio, tunnel section in loose rock material.



Fig. 14: Portal Bodio, lining installations before moving into the opencast constructed tunnel.

1. A bypass-adit – headed with conventional drilling and blasting, with a total length of 1,200 m – to bypass the very delicate and time-consuming loose rock zone at the portal of the base Tunnel. The bypass was excavated in good rock conditions. The two 15 km tunnel tubes in Bodio, leading north in the direction of Faido started in the cavern at the end of the bypass.
2. The 3.2 km long mucking tunnel, which will serve as a conveyor belt tunnel. The conveyor belt system (3.7 km long) will transport 6 million tons of debris to the neighbouring Blenio valley. The mucking tunnel was excavated by means of a 5m-diameter TBM. The work was finished in April 2001.
3. The opencast constructed Tunnel (380 m long), including the portal (see Fig. 14). The construction works has been completed successfully in July 2003.
4. The tunnel section in the loose rock material that follows the open cast construction, which is also close to 410 m long. This tunnel section was excavated through very delicate rock fall and loose rock material (see Fig. 13). To drive the heading through this zone, auxiliary measures have been taken such as putting a pipe screen umbrella in place and undertaking a large amount of grouting. The heading of this section has been completed successfully in June 2003, on time and in full respect of the expected costs.
5. Finally all the processing plants that recycle the debris into concrete aggregates, or the conveyor belt systems that will transport the surplus debris through the mucking tunnel to the Buzza of Biasca stone quarry or to the construction site of the open air part of the new railway route.

In January respective in February of the last year the two TBMs in the Bodio section with a diameter of 8.80 meters each, installed in underground installation chambers, started their journey. More than 4.0 km in the west and 5.1 km in the eastern single track tube have been driven thus far. The TBMs (see Fig. 15) still have about 9 km each to go. The best performances up to July 31<sup>st</sup> 2004 are 35.00 m within a single day and 512.00 m within a single month; at the present time the daily average heading rate is of about 10.21 m (TBM west) respective to 7.13 m (TBM east).

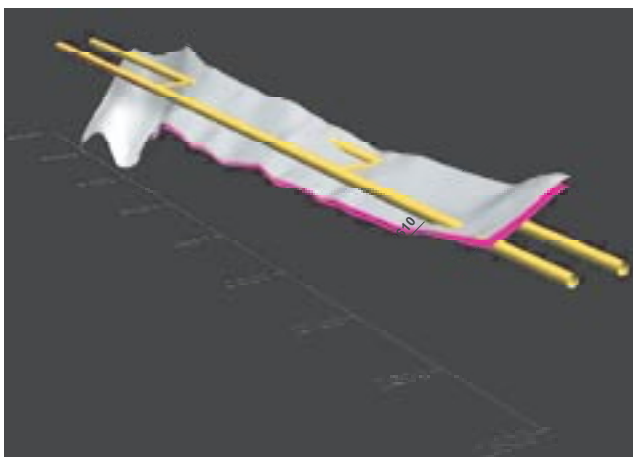

Fig. 15: Tunnel Bodio, installation of the TBM in an underground chamber.



Fig. 16: Tunnel Bodio, unexpected fault zone "Tm 2,705".

During the "learning" phase, shortly after the start of the TBMs, also in Bodio the TBM headings met a unpredicted fault zone. The flat lying zone followed the tunnel tubes for some 500 m in the eastern and nearly 60 m in the western tube (see Fig. 16). In autumn last year this fault zone was successfully penetrated. The average heading rate in the fault zone was approximately 2.45 m per day. After that the average heading rate increased to 13.13 m (TBM west) respective to 12.21 m (TBM east) per day this year.

In April 2004 the concreting of the lining support and of the lining itself has been started in the west tube. About 500 m of final lining have been executed using the especially designed formworks with variable geometry installed on the so-called "worm" (see Fig. 16).

#### Environmental considerations

The Swiss population is in general very sensible for environmental problems and the Swiss government did and does set high priority on the preservation of the territory and of the water resources. Several federal laws prescribe measures to protect persons and the nature from contamination, pollution, noise and different kinds of waste. An important recycling quote has to be attempted. To respect all these incisive dispositions, different concepts and technical solutions have been adopted in this project in order to reduce as far as possible temporary and permanent effects caused by the construction works and by the final deposit of the muck.

The volume of the excavation of the complete Gotthard base tunnel (including galleries and multifunctional stations) is estimated in about 13.3 millions of cubic me-

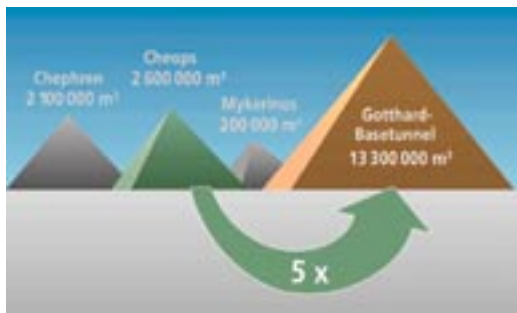

Fig. 17: Gotthard base tunnel, volume of excavated material.



Fig. 18: Gotthard base tunnel, recycling of excavated material.

ters; with the entire produced volume of muck it would be possible to build five new pyramids with the same size of those of Cheops (see Fig. 17). On all construction sites material processing plants have been realized in order to recycle the muck and to produce concrete aggregates. Depending from the petrography and the properties of the excavated material, according to the predicted geology, about 28% of entire muck will be processed; the expected recycling rate is around 85% (concrete aggregate production about 22% of entire muck). A part of it is used as filling material and the rest is transported to final deposits or to an inert landfill (see Fig. 18).

The contamination of the muck – cause of loss of oil from the machines (especially the TMBs), waste products from the use of explosives, chemicals and heavy metals from rebounded shotcrete – not ever permit to store this material in a “conventional” inert landfill. The requirements for “non contaminated” muck are very high and at the present time about 1% of the excavated material of the section Bodio has been transported to a special reactor landfill. This is related to intensive costs, caused by the extremely high level of the deposit and treatment prices. To reduce noise and pollution, muck is transported with conveyor belt systems above ground and it is sprayed with water to avoid dust production.

Wastewater from the tunnel and from several technical installations outside the tunnel is treated to reduce the acidity (pH), to neutralise chemicals, to separate oils and particles in suspension. After the treatment, if necessary, the temperature of the cleaned water has to be reduced prior to the introduction in a river or before being recycled for industrial use or as liquid for the cooling system in the tunnel (see Fig. 19, treatment of maximum 200 l/s, recycling of about 5÷10 l/s). The mud cake resulting from the treatment of wastewater is pressed to reduce water content and is handled with the same criteria for the muck. In general the quality of the cake is “contaminated”, especially because of the concentration of oils.



Fig. 19: Construction site Bodio, treatment of wastewater from the tunnel.



Fig. 20: Construction site Amsteg, encapsulated plants and conveyors belt systems.

To reduce the impact of noise from the construction sites on the nearby living populations the required standard of some installations, like tunnel train wagons, have been set very high. Concrete production plant, material processing plant and conveyors belt systems have been encapsulated (see Fig. 20). Temporary dams and absorbent walls have been extra erected to avoid the propagation of very noisily activities.

#### Conclusions

The construction works of the Gotthard-Base Tunnel are proceeding at all fronts ahead. Up to now, some parts with bad geological conditions did delay the excavation-schedule of the Faido and Bodio sections. But two of the seven predicted geological difficult zones, the Intschi-zone in the Amsteg section and the tunnel section in the loose rock material of Bodio, have been completed successfully.

Rail technical equipments for the Gotthard-Base Tunnel are scheduled to be published in the Swiss official trade gazette in Summer 2005 by the AlpTransit Gotthard Ltd.

The Gotthard-Base Tunnel will be a milestone for the realisation of the New Alpine Transverse in Switzerland. A total investment of about 30 billions Swiss francs (33 billions AUD) is going to be realized to ensure a future with sufficient transport capacity for the ever-increasing rail-traffic between north and south of Europe. A tunnel with an elevated standard of safety and technology, with several "new land" and "world-premiere" solutions. An important contribution to the preservation of the Alps.

Original articles written on the subject:

1. A. Henke - "Das Hauptlos Faido/Bodio aus Sicht des Projektingenieurs", Fachtagung AlpTransit Schweiz, FGUSIA, Thun 2002
2. L. Rondi., A. Theiler - "Tunnelling in rockfall deposits - Dealing with extreme asymmetry", ITA Congress Amsterdam, 2003
3. A. Henke, H. Ehrbar - "AlpTransit Gotthard: Aktuelle Erfahrungen und Entwicklungen beim Bau des Gotthard-Basistunnels", GTMM Symposium Karlsruhe, 2003
4. D. Fabbri - "Concetto di ricognizione per l'avanzamento fresato nella tratta di Bodio", Pubblicazione della Società Svizzera di Meccanica del Suolo e delle Rocce, N° 144, Riunione di primavera 19.04.2003 a Bodio
5. D. Fabbri, S. Schoch, M. Rehbock, B. Boss - "Gotthard-Basistunnel: Progress and Planning", "Bodio Part-Section, TBM Drive: Producing the in Situ Concrete Floor", Tunnel 4/2003.
6. S. Flury, D. Fabbri, M. Neuenschwander - "Gotthard Base Tunnel Bodio, Part-Section", Tunnel 04/2004.

References on the internet:

AlpTransit Gotthard Ltd., Homepage: [www.alptransit.ch](http://www.alptransit.ch)

## The Gotthard Base Tunnel: Fire / Life Safety System

Andreas Henke, Director, dipl. Ing. ETH/SIA  
Davide Fabbri, chief designer, dipl. Ing. ETH/SIA  
Engineering joint-venture Gotthard Base Tunnel South  
(Lombardi Engineering, Amberg Engineering, Electrowatt Infra)

### Abstract

The Gotthard Base Tunnel will be the world longest railway tunnel, with a length of 57 km. The tunnel is part of the New Alpine Transverse in Switzerland. The dual purpose of this project is to provide a high speed link for passengers between Germany in the North and Italy in the South of continental Europe and to transfer freight traffic from the roads to rail. It represents also an essential step to protect actively the sensitive region of the Alps and to get an important contribution to preserve the environment in general.

A high safety level is a very important premise for the operation of a railway tunnel and as well an economic exigency. In order to plan and realise a safe operating base tunnel, a safety concept serves as a rail-internal instrument for continuous planning and optimisation of safety measures and as a transparent basis for the control by the competent authorities. The analyses in the Gotthard Base Tunnel safety concept demonstrate, that with simple but very effective measures, a very high safety level can be reached, corresponding to the demanded safety requirements.

After the October 2001 Gotthard road tunnel fire, which caused 11 fatalities, and after the Kaprun funicular tunnel fire (Austria), where 155 persons died, a group of engineers has been charged to submit constructive measures to increase the fire/life safety and to reduce the damage of the structures in case of such an event.

### Introduction

Fires in rail tunnels are very unusual events: the actual transalpine rail routes through Switzerland, containing over 500 tunnels (total length around 400 km), are more than a hundred years old and tragic accidents related to fires have not been reported. For the public opinion that meant, that rail tunnels are "safe". But after the tragic fatalities of Mt. Blanc and Gotthard road tunnels, as well as of Kaprun, the public opinion shows special sensitivity to tunnel safety: in general clients and project managers were called upon to undertake every reasonable effort to increase tunnel safety further.

### The evaluation of the tunnel design

At the time of the preliminary project (year 1993), different variants of the tunnel system have been evaluated with a comparison of costs, excavation- and lining-schedule, technical difficulties of zones with bad geology (high rock mass pressure), aerodynamic effects, fire/life safety system and environmental considerations (especially muck deposit). In the end the tunnel system with 2 single-track tubes and a higher quality standard has been preferred (see Fig. 1). In accordance with the tunnel system, both multifunctional stations (intermediate attack of Faido and of Sedrun) and the ventilation system have been designed.

Fig. 1: Tunnel systems evaluated



### Requirements

A fire in the Gotthard Base Tunnel is a “worst case”: in fact, the probability of such an accident is very low. The following requirements have to be satisfied in the case of an accident:

1. Availability during an event. In case of fire, the safety of persons has first priority. In order to assure this, the availability of the tunnel has to be maintained as long possible, as persons should be able to reach a safe place. This is a must! In consideration of the fire/life safety system this means:
  - no damages in the safe (opposite) tube during the first 45 minutes. An evacuation train (opposite tube) and the fire-fighting & rescue train reach the spot in approximately 45 minutes.
  - no major damages or collapse in the burning tube during the first 90 minutes.
2. Availability after an event. In case of fire, the interruption of tunnel traffic has to be as short as possible. After the rescue, the reopening of the railway line has first priority. In order to assure this, constructive fire-protection measures have to be taken:
  - to exclude major damages or collapse of the safe tube
  - to reduce resulting damages, time and costs for the repair of the burned tube.

### The Fire/life safety system

The tunnel system (see Fig. 2) mainly consists of two single track tunnels with two train-crossover sections in the so called multifunctional stations. Along the tunnel, cross passages are located every 310÷325 m approximately; the horizontal distance between the tube axes is varying between 40 and 70 m. In front of the tunnel portals turn-out tracks are arranged.

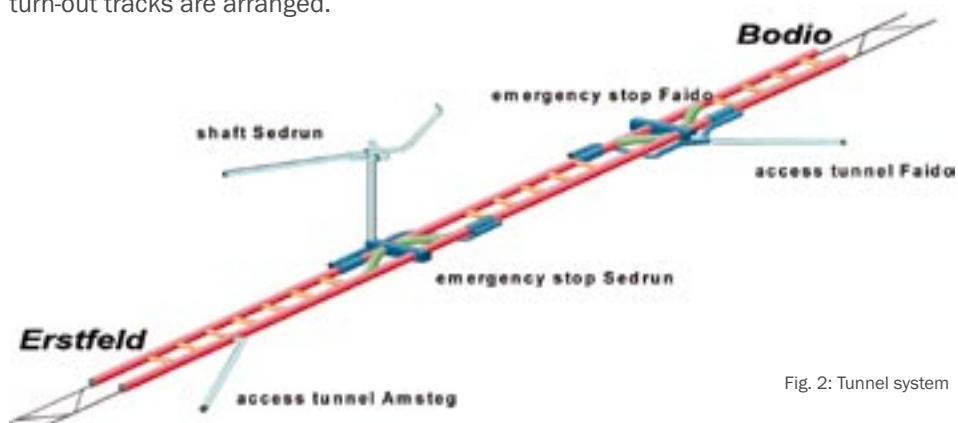

Fig. 2: Tunnel system

For tunnel safety planning, in first priority preventive measures have been designated and in second priority curative measures have been defined in addition. This principle paid off during decades in railway technique. Should an incident happen in spite of these measures, particular measures facilitating the self- and external rescue will be applied.

In general every failure of the safety system has to be prevented, otherwise the personnel on the spot (train crew, engine driver) has to deal with it (radio contact to the control centre). If unsuccessful, the train has to leave the tunnel or stop at an emergency stop station with highest priority. Assistance from the outside can be expected – depending on the exact position of the train in the tunnel – after 30 minutes at the earliest (e.g. train at emergency stop station).

In the tunnel control centre well-trained Traffic-Controllers survey the train running and the technical infrastructure. The Swiss Federal railways develop an early warning system to detect irregularities in the operation in real time. In case of an incident the Traffic-Controllers activate defined and rehearsed procedures using check lists. Always the purpose is to manage the situation quickly, preventing an escalation. It is also important to ensure the operating flow and to achieve a stable operating situation.

In case of a fire on board of a (passenger) train, the procedure of the safety concept depends on the position of the train in the tunnel. Three cases have to be taken into account:

1. The train is running in the last section of the tunnel (after the second multifunctional station): the train has to reach the portal and will stop in the open air. Passengers are able to leave the train.
2. The train is running in the first or in a intermediate section of the tunnel: the train has to reach the next multifunctional station and stops there for the evacuation of passengers (see Fig. 3). The passengers reach the “sheltered area” of the emergency stop station within 3 to 5 minutes. Prior to the arrival of the train, after the fire-alarm, the lights of the emergency station will be turned on, the sliding-doors of the escape ways will be automatically opened and the ventilation system starts

the extraction of smoky exhaust air from the traffic tube trough the middle of the seven fire dampers (only after exact location of the fire it will be possible to open the nearest fire damper). After evacuation from the train – without using stairways or elevators – passengers will wait at the emergency stop station of the opposite tube for a rescue exclusively by train (multifunctional station Sedrun: no evacuation through the shafts; multifunctional station Faido: no evacuation through the access tunnel).

The emergency stop stations (sheltered areas) as well as the lateral and connecting galleries are furnished with fresh air independent of the traffic tun-

Fig. 3: Emergency (rescue) station

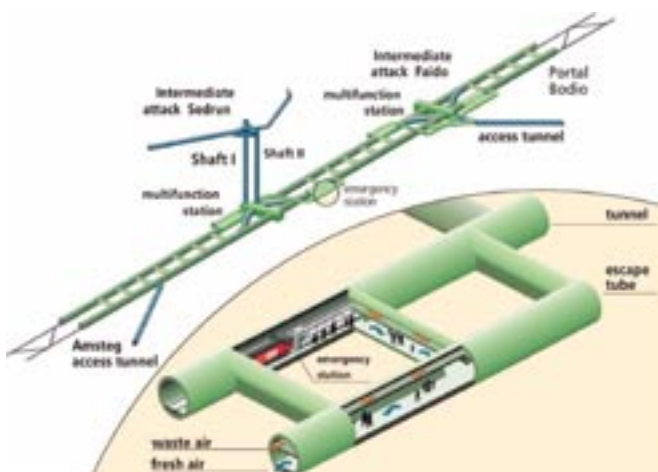

nel system, they are kept smoke-free through overpressure. An evacuation train conducts the passengers outside the tunnel. And this leads to another principle: the rescue from the outside is rail-bound. The evacuation train is either a train emptied in front of the tunnel or a train already in the tunnel.

Fire-fighting and rescue trains come in action from the south-end as well as from the north-end of the tunnel. The rail-bound rescue is proven and trained for years at the Swiss Federal Railways (Simplon Tunnel 19 km, Gotthard Tunnel 15 km). In order to shorten the time period until the forces are ready, a close co-operation with local intervention forces (fire brigade, ambulance and police) is of great importance. This represents an extraordinary challenge for the upcoming years.

3. A fire event occurs and the train is not able to reach the next multifunctional station or to exit the tunnel. In this case the train will stop at any position in the tunnel and the evacuation occurs. On a 1 m-wide side walk escaping passengers will be able to reach and to enter the next cross passage and reach the safe tube (see Fig. 4). In the opposite tube the speed of the trains running is reduced immediately after alert, minimizing the run over risk for escaping people. In this case the process

Fig. 4: cross passages (escape way)

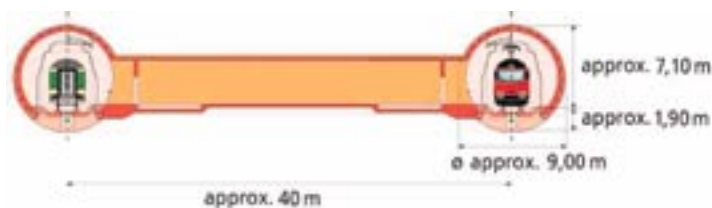

of the external rescue proceeds in the same way as if the train stopped in an emergency stop station. In any case the train crew has to act quickly and resolutely. Early and clear instructions help to prevent panic situations.

Fire-resistant doors (90 minutes resistance with AlpTransit temperature-time-diagram) will provide fire-protection of the escape way and of the technical equipment inside the cross passages. The ventilation system will assure overpressure conditions in the safe tube to avoid the propagation of smoke from the burning one.

On almost every incident an evacuation train or the fire-fighting and rescue train is able to arrive on the spot within 35 to 45 minutes; the evacuation of the passengers will be completed after 90 minutes at the latest.

To prevent incidents with hazardous goods the drainage system is equipped with siphons and is always charged with water i.e. in case of fire/explosion the next drainage shaft interrupts a further propagation of the fire/explosion. To limit the formation of puddles in the low declined tunnel, traverse beams are installed. Storage basins at the portals facilitate to collect contaminated water for some hours, to treat the water or to let it off to the sewerage plant.

#### The Ventilation system

In February 2002 the Swiss Federal Office of Transportation requested to upgrade the ventilation system of the Gotthard Base Tunnel to permit the extraction of smoke at 7 different locations in both underground emergency stations, in order to ensure sufficient air quality, temperature and visibility conditions in case of a fire break-out and the necessary evacuation of passengers and staff.

In the system of the Gotthard Base Tunnel, emergency stations are located in the multifunctional stations, where burning trains will stop in case of fire. To permit an



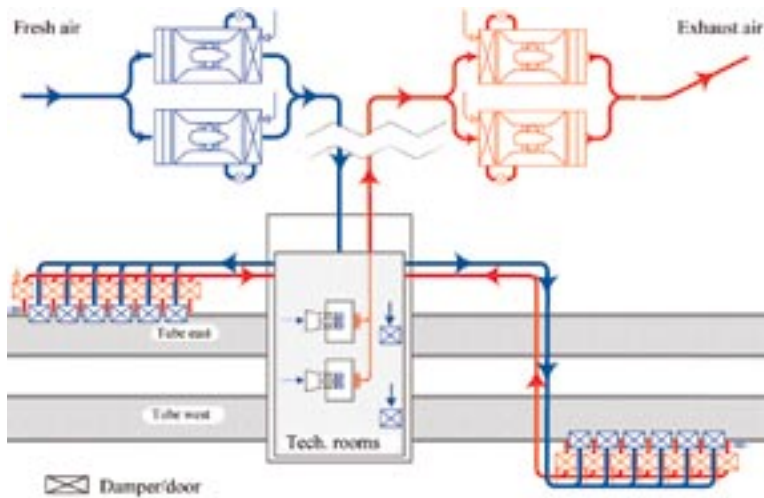

Fig. 5: MFS Sedrun: fresh and exhaust air systems (main fans)

efficient and safe evacuation of the passengers, it is required to extract exhausted air (smoke) near to the fire and to supply fresh air with overpressure in the escape ways and in the opposite tube (see Fig. 5). Main fans (redundant, 2 x 2.6 MW for extraction and 2 x 0.5 MW for fresh air) will be installed in the ventilation plant located near the portal of the intermediate access of Faido as well as in the ventilation plant in the cavern on shaft top in Sedrun. The amount of air blown in and exhausted will be about 200 m<sup>3</sup>/s and 250 m<sup>3</sup>/s respectively. In each emergency station seven fire

dampers, located on the top of the lining, and six emergency sliding doors will complete the ventilation system.

The technical rooms are separated from the railway tunnels: in case of fire, as normally during service, these rooms will be ventilated to maintain the required temperature. Overpressure in case of an accident will prevent the propagation of smoke and air with high temperature in the technical rooms (see Fig. 5).

Subsidiary boosters (6 jet fans, each rated at 40 kW) will be additionally installed near to both tunnel portals in Bodio and in Erstfeld as measure to maintain the difference of pressure between the tubes (see Fig. 6). This is very important, if a burning train will stop close to the portal.

Fig. 6: Boosters (portal Erstfeld)

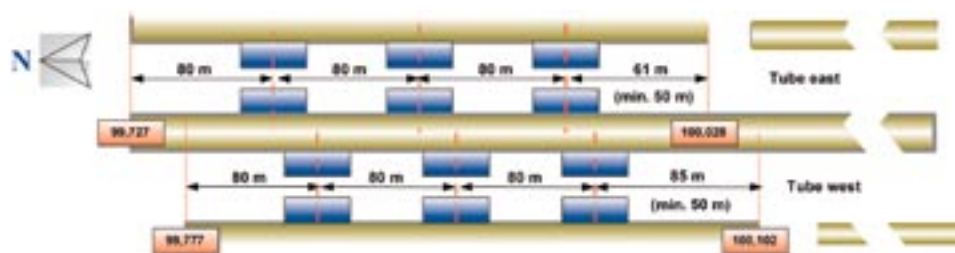

### Fire-protection measures

In February 2003 a special task force has been created to study the problem of availability of the tunnel during and after an event, and to ensure the full respect of the extremely severe requirements set by the AlpTransit Gotthard Ltd. in case of a fire accident.

For the evaluation of the design of the tunnel-structures a fire-power of 250 MW (freight train) respective of 40 MW (passenger train; only 20 MW for the design of the ventilation) has been supposed. The first question to be answered by the fire-protection working group was about the fire scenario to take into account. At European level, different temperature-time-diagrams have been developed: the Hydrocarbon (HC, about 1,100 °C), the increased Hydrocarbon (HCM, about 1,300 °C) and the ISO (max 1,000 °C). But a new temperature-time-diagram has been adopted for the AlpTransit-

projects, to considerate better the particular fire-event scenarios and the effective design of the Gotthard Base Tunnel (see Fig. 7). Experiences from former events have confirmed, that not only the first 90 min or the first hours have to be observed (peak of the temperature), but also the cooling phase.

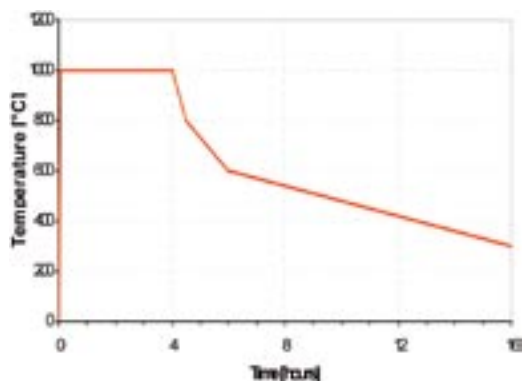

Fig. 7: AlpTransit temperature-time-diagram



Fig. 8: Fire-Protection tests

After the choice of adequate fire scenarios for the Gotthard-Base Tunnel several studies about the propagation of high temperature and the behaviour of airflow in case of incident have been undertaken, some tests with fire-protected concrete have been done in order to decide about the adequate constructive measures to be adopted (see Fig. 8). In particular polypropylene-fibres have been added to concrete specimen – prefabricated with the use of on construction site produced aggregates – to observe the occurring damages with the application of the AlpTransit fire-diagram, in order to find out the optimal design. In consideration of fluidity and workability of concrete,  $2 \text{ kg/m}^3$  resulted to be ideal.

On July 2004 the board of AlpTransit Gotthard Ltd. accepted the constructive measures elaborated by the working group: protection of sensible sections of the tunnel system with  $2 \text{ kg/m}^3$  PP-fibres-added, fire-protected concrete lining and post-application of fire-protecting shotcrete (thickness: 3 up to 7 cm) on the completed lining in the cut & cover section. The lining of shaft II (exhaust air) has also been protected with PP-fibres-added shotcrete.

#### Prevention and procedures during construction works

Prior to the public submission of the works, a high safety standard has been established for the entire AlpTransit project. In accordance with the SUVA (Swiss National Accident Insurance Fund), a fire/life safety system concept has been developed for the construction phase of the Gotthard Base Tunnel (see Fig. 9 and 10).

Experiences from former events have confirmed, that an intervention of an external fire brigade needs up to 20÷30 min. to reach the fire in the tunnel. This is definitively too late: at this time it is nearby impossible to extinguish the flames, due to high temperatures (up to  $1,000^\circ\text{C}$ ) and bad visibility conditions (smoke). In case of fire in the tunnel the first minutes are absolutely crucial: after the activation of the fire-alarm by a manual alarm-system or by communication-system (phone or radio) – if the starting-fire cannot be extinguished – self-protection procedures have to be adopted.



Fig. 9: Fire event with blocked staff at the front

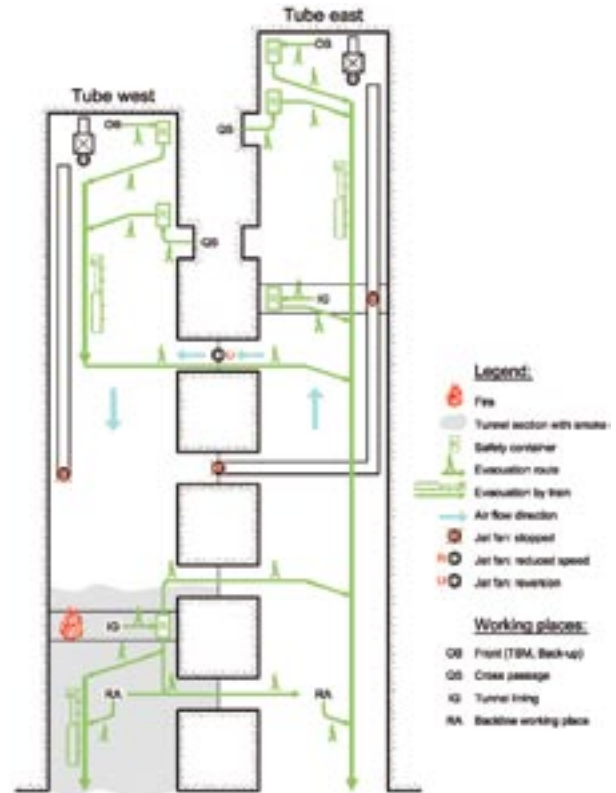

Fig. 10: Fire event without blocked staff

For every member of the staff in the tunnel a personal self-rescue-device (oxygen-mask, 30 min. endurance) is provided to permit, in case of fire, to reach the nearest safety container. A fire-protected pressurized-air supply system provides overpressure in the safety containers, where extra self-rescuedevices (60 min. endurance) for the evacuation of the tunnel are available.

After the evacuation or after reaching the safety containers a reduction or a reversion of the ventilation flow prevents the propagation of smoke in the other tube and cuts the oxygen supply in the burning tube. First-aid treatment of injured staff members and the intervention of the fire-brigade to free blocked staff are the last steps of the procedures in case of fire during the construction works.

A permanent occupied safety control centre (see Fig. 11) is charged for the monitoring and coordination of rescue-operations in case of fire. First instructions of the staff and their continuous upgrade are absolutely necessary (instruction is provided from fire-brigade instructors). Exercises are scheduled to check the correct application of self-protection procedures and to upgrade the experience of the firebrigade about the progress of the construction works underground (see Fig. 12).



Fig. 11: Safety control centre



Fig. 12: Exercises with the external fire brigade

#### Conclusions

After the tragic fatalities of Mt. Blanc and Gotthard road tunnels, and of Kaprun funicular tunnel, fire/life safety systems and fire-protection measures are very important aspects of the design, construction and management of road and railway tunnels.

For the Gotthard Base Tunnel two different fire/life safety systems have been developed: a selfprotection concept for the safety of the staff during construction works, and an evacuation and rescue concept for the regular train service in the tunnel. The teaching and training of the rescue staff will be initiated early.

To assure the feasibility and efficiency of safety concept, the ventilation system has been upgraded and constructive fire-protection measures – like fire-protected concrete, post-application of fireprotecting shotcrete and high resistant cross passage doors – have been adopted. Tests with PP-fibres have been undertaken to check the ultimate resistance under AlpTransit-fire-scenario conditions. The results of the tests have been very positive.

Original articles written on the subject:

1. D. Fabbri - "Concetto di ricognizione per l'avanzamento fresato nella tratta di Bodio", Pubblicazione della Societa Svizzera di Meccanica del Suolo e delle Rocce, N° 144, Riunione di primavera 19.04.2003 a Bodio
2. D. Fabbri, S. Schoch, M. Rehbock, B. Boss - "Gotthard Base Tunnel: Progress and Planning", "Bodio Part-Section, TBM Drive: Producing the in Situ Concrete Floor", Tunnel 4/2003.
3. S. Flury, D. Fabbri, M. Neuenschwander - "Gotthard Base Tunnel Bodio, Part-Section", Tunnel 04/2004.
4. H.-P. Vetsch, C. Kauer - "Safety of the Gotthard Base Tunnel" – SIIRT Safety in Road and Rail Tunnels, Conference Madrid Spain, April 2001
5. D. Fabbri - "The Gotthard Base Tunnel: Project Overview", The 6<sup>th</sup> Annual Tunnelling 2004 Conference, Sydney, 30<sup>th</sup> & 31<sup>st</sup> August 2004.

References on the internet:

AlpTransit Gotthard Ltd., Homepage: [www.alptransit.ch](http://www.alptransit.ch)

## Projektiranje predorskega sistema Šentvid

Angelo Žigon, univ. dipl. inž. grad. (angelo.zigon@elea.si)

Marko Žibert, univ. dipl. inž. grad. (marko.zibert@elea.si)

Peter Jemec, abs. grad. (peter.jemec@elea.si)

ELEA iC d.o.o., Dunajska cesta 21, SI-1000 Ljubljana, www.elea.si

### Povzetek

Koncem maja 2004 se je zaključila 1. faza izgradnje pokritega vkopa Šentvid, s čimer se je pričela gradnja predorskega sistema Šentvid kot ključnega objekta na navezavi gorenjske avtoceste A2 odsek Šentvid – Koseze na avtocestni križ Slovenije in Ljubljansko obvoznico. Trasa avtocestnega odseka Šentvid – Koseze se pred Šentvidom spusti pod teren in vzdolž predora poteka pod železniško progo, urbanim naseljem, Celovško cesto, predre Šentviški hrib in nazadnje izstopi na Pržanu. Glavni trasi avtoceste se pod Šentviškim hribom priključita še vstopna in izstopna cev, s katerima se omogoči povezavo Šentvida na ljubljansko obvoznico. Zaradi pestrosti geoloških, urbanih, prometnih in nenazadnje časovnih pogojev, je glavna predorska cev, skupne dolžine 1450 m, sestav različnih izvedbenih pristopov, od že zgrajene galerije Šentvid na severu, preko dveh novih pokritih vkopov do hribinskega dela predora. Prispevek se osredotoča na izbrane tehnične rešitve za dvocevni hribinski del predora Šentvid, vključno s priključnima cevema. Hribinski del predora se deli na štiri poglobitvene enote in sicer na dvopasovni del predora s standardnim karakterističnim profilom, priključno kaverno, tropasovni del predora in priključne cevi. Skupna dolžina vseh cevi je cca. 3000 m, v različno velikih izkopnih profilih od 81 m<sup>2</sup>, v priključni cevi do največjega 300 m<sup>2</sup>, v priključni kaverni. Predor bo potekal v permokarbonski kamenini, večinoma v skrilavih meljevcih in deloma razpokanem peščenjaku, z večimi prelomi zapolnjenimi s tektonizirano glino, ki ustvarja izrazito neugodne geomehanske pogoje za izgradnjo predora. Za natančno določitev lokacije priključnih kavern se bo predhodno izvedel raziskovalni rov, ki vključuje celostni program geološko-geomehansko spremljave.

### 1. Uvod

Vsako jutro delavnika, med sezonskimi poletnimi, spomladanskimi in jesenskimi konicami pa preko celega dne, dnevni migranti, utrujeni evropski turisti in vsega hudega vajeni prevozniki, negodujejo nad neurejeno cestno povezavo gorenjskega kraka avtoceste na osnovni slovenski avtocestni križ. Pot po Celovski cesti, v jutrih in popoldanskih urah natpani severozahodni vpadnici prestolnice, jih vodi preko več deset semaforiziranih križišč, mimo najbolj naseljenih ljubljanskih sosek do odcepa na krožno obvoznico, ki je sicer namenjena razbremenjevanju mestnega prometa. Posledice izrivanja mestnega prometa s strani tranzita, čuti celotno mesto, ki večkrat letno popolnoma ohromi.

Povečanje prometa na Celovski cesti gre iskati predvsem v povečani osebni rabi vozil, močno naraščajočem trendu preseljevanja prebivalstva na mestne obronke ter nenazadnje integraciji Slovenije v evropski prostor tj. njen skrajni vzhodni del.

Po zadnjih prometno tehničnih študijah, ki upoštevajo realne kazalce povečanja dnevne kvote vozil na Celovski vpadnici pa kaže, da bo v prihodnje ta prometna žila zadostovala le še za potrebe prebivalcev, ki živijo neposredno ob njej.

Tako kot danes, po izgradnji ustreznih navezav, nismo več priča neskončnim zastojem v Domžalah in Škofljici, bomo z izgradnjo navezave avtoceste A2 – Karavanke – Šentvid končali tudi dolgotrajajoče .....

Priprave na izgradnjo navezave so v preteklosti že večkrat stekle, vendar so bile zaradi organizacijsko-finančnih, morda tudi političnih razlogov ustavljene na bolj ali manj idejnih rešitvah. Morda je bil še najbolj obetajoč poizkus leta 1982 ob izgradnji štiri celične Šentviške galerije, pod Gorenjsko železnico v smeri proti Šentviškemu hribu. Gradnja se je zaključila po izvedbi priključnih ramp na Celovško cesto. Izkop pod Celovško cesto in Šentviškim hribom ter s tem povezanimi prometnimi težavami, pa je bil preložen v prihodnost. Danes, kljub težko obvladljivim prometnim težavam ob izgradnji podaljška galerije Šentvid pod Celovško cesto, lahko trdimo, da ima zavlačevanje izgradnje navezave tudi dobro plat. S tedanjim znanjem, izkušnjami in nenazadnje razpoložljivo tehnologijo, bi bila izgradnja predora pod Šentviškim hribom bistveno težje izvedljiva in na koncu tudi bistveno dražja. Izvedeni predor pa po dvajsetih letih ne bi več popolnoma zadovoljeval prometno tehničnih potreb rastoče prestolnice.

Kot projektanti t.i. predora Šentvid bomo v pričujočem prispevku predstavili projektne in tehnične rešitve ter nenazadnje zapleten razvoj dogodkov ob projektiranju tega trenutno najdražjega in najzahtevnejšega predora v Sloveniji.

## 2. Razčlenitev projekta

### 2.1 Opis trase predora

Obstoječa trasa gorenjske avtoceste se zaključi pri priključku Brod. Od tu se leva in desna os trase razmakneta v vstopno izstopni krak do galerije Šentvid, koder se trasa dvigne na nivo Celovške ceste. V vmesnem še ne izkoriščenem območju je predviden pričetek trase odseka AC Šentvid – Koseze. Celotna dolžina trase, ki se členi na tri distinktno enote; Brod – Severni portal (660 m), Predor Šentvid (1450 m) in Južni portal – Koseze (3440 m), je 5550 m. Večji del trase poteka v urbanem okolju z urejenimi prostorskimi akti.

S predorom Šentvid se omogoči nemoten prehod pod Šentvidom kot urbanim delom z razvejano prometno infrastrukturo (železnica, cestna vpadnica ter peš in kolesarske poti) in Šentviškim hribom kot klasičnim rudarskim predorom. Zato v grobem razdelimo predor na urbani in klasični rudarski del, saj je pristop k načrtovanju in izvedbi popolnoma drugačen.

Urbani, severni del prečka gosto poseljeno območje z dvema močnima prometnima žilama, železnico in Celovško cesto in se deli na predhodno izvedeno »Galerijo Šentvid« v skupni dolžini cca. 250 m in v nadaljevanju »Pokriti vkop Šentvid« vse do pod Celovške ceste v dolžini cca. 140 m. Za celovško cesto se predvidi »Vezni del«, s katerim se predor navezuje na klasičen rudarski dvocevni predor. Ta poteka do južnega portala na Pržanju.

Vsi sklopi se gradijo sukcesivno v več fazah. V izgotovljenem stanju bo predor deloval kot funkcionalno enoten objekt s skupno opremo.

Niveleta glavne osi predora preide iz preme preko radija v vzdolžni sklon cca. 2.2%. Po cca. 750 m vzdolžni sklon prične padati, tako da trasa doseže vrh neposredno po izstopu iz predora na južnem portalu v Pržanju. Povprečna dolžina cevi je 1480 m od tega 1060 m v rudarskem izkopu in 390 m v pokritem vkopu.

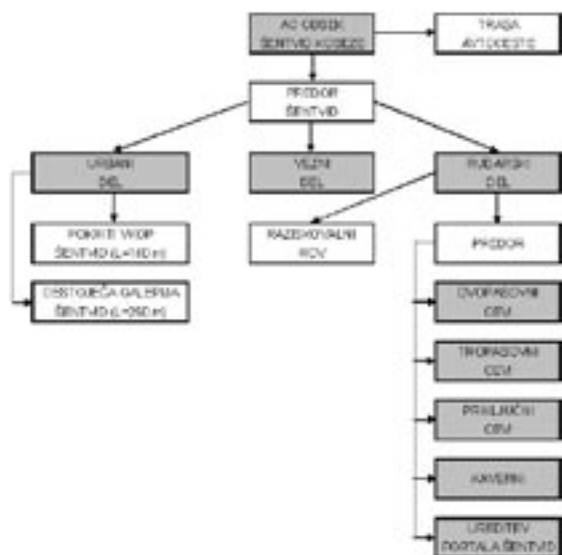

## 2.2 Opis faznosti izgradnje

Zaradi kompleksnosti izgradnje predora in finančno terminskih okvirov je bil le ta ob pričetku načrtovanja, januarja 2003, razdeljen na začetna dela in glavno predorsko cev. V sklopu začetnih del se je pospešeno pripravila projektna dokumentacija za podaljšanje galerije Šentvid vključno s podkopavanjem pod Celovško cesto. Izvedba pokritega vkopa se je pričela koncem leta 2003, dela na površini pa so se zaključila s ponovno vzpostavitev začasno premaknjene Celovške ceste maja 2004.

Medtem so vsa dela, vključno s projektiranjem glavne cevi zastala v septembru 2003, na nivoju revizijskega pregleda. Tedaj je bila s strani MOL-a predstavljena prometna študija širšega območja Šentvida, katerih izsledki so kazali na nujnost izvedbe polnega priključka Celovške ceste na AC Šentvid – Koseze. Sledile so mnoge študije z vidika prometno-tehničnih možnosti umestitve zahtevanega priključka v Šentvidu, hkrati pa se je izvedla geotehnična preverba možnosti izgradnje različnih variant predorov s skupnim ciljem navezave na AC odsek.

Predstavljene in ocenjene s primerjalno študijo so bile variante z glavnim dvopasovnim predorom in po dvema enopasovnim enosmernima predoroma s končnim priključkom v Pržanju, z glavnima dvopasovnim cevema in enim dvopasovnim dvosmernim predorom ter nenazadnje še izbrana varianta. Ta je predvidela izgradnjo dveh priključnih kavern, ki bi omogočale navezavo priključnih cevi na traso avtoceste, pri čemer bo predor od kaverne naprej dvopasovni z dodatnim pospeševalnim/zaviralnim pasom. Predlagana varianta je bila ocenjena kot najbolj učinkovita z gledišča hitrosti, racionalnosti in fleksibilnosti izgradnje.

Zaradi izjemnih dimenzij načrtovane kaverne, si je bila stroka enotna, da so v tako pestri geološki zgradbi, potrebne dodatne raziskave, s katerimi bi bilo mogoče potrditi ali ovreči racionalnost izvedbe, hkrati pa določiti natančno lokacijo priključkov. Vse zastavljene zahteve po dodatnih raziskavah je bilo možno izpolniti le z izvedbo raziskovalnega (sondažnega, pilotnega, smernega) rova, majhnega izkopnega profila.

Med sprejemanjem vseh potrebnih odločitev za potrditev spremenjenega terminskega in finančnega plana, so že potekale priprave na izvedbo rova. Razpisna in projektna dokumentacija je bila pripravljena v nekaj tednih. Izvajalec pa je pričel z deli, konec maja 2004.

Do konca junija so bili pripravljene in sprejeti vsi pogoji za izvedbo razpisa za izbiro izvajalca gradbenih del po načinu kombinacije dvopasovne leve cevi brez priključka in desne cevi s priključkom na Celovško cesto. Razpis za izvedbo predora je bil razdeljen na gradbena dela, geološko-geomehansko spremljavo ter elektro-strojno opremo predora. S tem načinom si je naročnik omogočil lažji pregled in kontrolo nad izvedbo, hkrati pa si je zavestno pridobil čas za dokončno potrditev možnosti izvedbe kaverne.

V času do maja 2004 je naročnik pridobil gradbeno dovoljenje za prvotno, dvopasovno varianto predora. V primeru načrtovane potrditve izvedbe kaverne pa bo to

dovoljenje potrebno dopolniti, hkrati pa spremeniti ustrezne prostorske akte na tem področju.

Sočasno z načrtovanjem razširjenega predora, se je načrtovala tudi razširjena izvedba ostalega dela trase, vključujoč prizadete cestne objekte med Pržanjem in razcepom Kozarje.

Načrtovani pričetek del je predviden za december 2004.

Slika 2-1: Primerjava velikosti projektirane kaverne in sedeža DDC na Kotnikovi ulici.

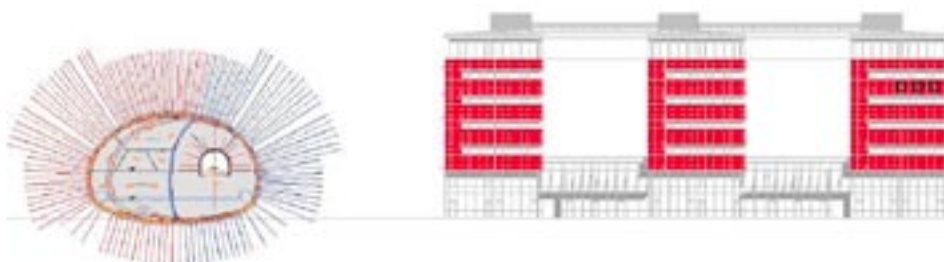

### 3. Opis geološko-geomehanske situacije

#### 3.1 Splošni opis

Kot je bilo že omenjeno, je zaradi sinklinalnega narivanja večji del hribinske mase razpokan, pretrt in tektoniziran ali kako drugače poškodovan. Glede na ugotovitve terenskega kartiranja in raziskovalnega vrtenja je ugotovljeno, da se v območju predora nahajajo tri luske s subvertikalnimi prelomnimi conami (severna, srednja in južna). Znotraj narivnih enot so nastale sekundarne poševne gube, ki slabšajo geomehanske pogoje izkopa.

Na trasi predora ločimo dve litološki enoti hribinske podlage iz permokarbonskih sedimentov:

- muljevec (masiven temnosiv sljudasti meljevec in glinovec) in glinasti skrilovec (tankoskrilavi sljudasti glinovec in meljevec) z več metrov debelimi plastmi peščenjaka (mu-gs CP)
- menjavanje glinastega skrilovca in skrilavega meljevca s sivim peščenjakom (pem CP)

Ostale plasti hribine pa so sestav sledečih litoloških enot:

- preperete hribinske podlage
- subvertikalnih tektonskih con v prelomih med luskami, v katerih se nahaja tektonska glina
- in zaglinjenega pobočnega grušča iz kvartarnih sedimentov na severnih pobočjih Šentviškega hriba

#### 3.1 Geomehanski opis lastnosti posameznih plasti

Permokarbonski mehanski sedimenti (klastiti) so močno razpokani. Zaradi prisotnosti peščenjaka, v plasteh pem CP, ki ležijo na severnem in osrednjem delu trase, imajo le te boljše geomehanske karakteristike od plasti (mu-gs CP). Slednje uvrščamo po RMR klasifikaciji v razred slabih hribin (35 točk) medtem, ko lahko za siv kremenov peščenjak trdimo, da gre za dobro hribino (II-III razred; 42 točk).

Kvartarne sedimente predstavlja srednje gost do gost grušč, v katerem se pojavljajo meljne glin. Grušč vsebuje posamezne kose peščenjaka in glinovca. Na posameznih delih se voda zadržuje nad vodonepropustnimi zaglinjenimi plastmi. V



teh predelih je grušč razmočen (posebno ob večjih količinah padavin) in ob izkopu ter posledično odtoku vode izgubi vso kohezijo. Na teh mestih se zemljina obnaša kot židek material brez samonosilnih sposobnosti.

V tektonsko pretrtih conah se je hribina preoblikovala v tektonsko glino in zdrob. Za te cone so značilne izredno slabe geomehanske karakteristike (RMR V. razred). Ugotovljeno je, da se lahko pričakuje v teh conah curljanje in lokalni dotoki vode. Debelina tektonskih con je ocenjena na 10 m.

Podrobnejši opis geološke situacije s prerezi in natančno interpretacijo je podan v posebnem prispevku avtorjev J. Cadež, dr. J. Kleberger, mag. W. Gensser in mag. I. Poeschl.

#### 4. Pokriti vkop Šentvid

##### 4.1 Izbira zasnove

Ideja povezave med gorenjsko in ljubljansko obvoznico skozi Šentviški hrib je stara že vsaj trideset let. Prvotna zamisel izvedbe pokritega vkopa v območju prečkanja Celovške ceste sledi zasnovi, ki je bila uporabljena pri izvedbi Šentviške galerije. Ta je zgrajena po principu odprtega izkopa. V odprti gradbeni jami so se na licu mesta izvedle dve stranski in sredinska stena dvoceličnega profila, preko katerih nalegajo montažni nosilci T prereza. Nosilci so povezani s tlačno ploščo in v celoti zaščiteni s črno hidroizolacijo. Prvotni projekti iz leta 1984 predvidevajo izvedbo v celotni dolžini, vendar pa so bili izvedeni zaradi finančno-organizacijskih zapletov le do kampade 14, ki se konča 12 m južneje od zaključka galerije v smeri trase avtoceste. Od tedaj pa do danes, so se bistveno spremenili urbanistični, prometni, ekološki in ostali faktorji na tem območju, zato ni bilo mogoče slediti prvotni zasnovi galerije.

S strani naročnika so bili postavljeni strogi finančni, časovni in kakovostni okviri, zato so bile v fazi idejnega projekta s strani projektivne skupine iC-Consulten, pod vodstvom ing. Dallerja, preverjene številne variante. Variante z rudarskim podkopavanjem ali podrivanjem pod Celovško cesto v obratovanju, so se ob upoštevanju tveganosti izvedbe in možnosti poškodovanja komunalne infrastrukture, izkazale za finančno in časovno neustrezne. Vsem zadanim pogojem pa je ustrezala izbrana ideja z začasno prestavitvijo Celovške ceste in spremljajočih komunalnih vodov v podporo izgradnji pokritega vkopa s površine.

Ideja, v svetu že večkrat preizkušene metode je, da se iz površine izvede samo pokrov oz. zgornja plošča pokritega vkopa na predhodno izvedenih AB pilotih. Vsa izkopna dela pod pokrovom se izvedejo kasneje, ko se na površju že vzpostavi prvotno stanje.

V primeru pokritega vkopa Šentvid, je bilo potrebno, zaradi komunalne infrastrukture, dvigovanja nivelete uvoznih ramp vzdolž trase in prečkanja Prušnikove ulice, nivo pokrova spustiti cca. 6,00 m pod koto Celovške ceste. Nivo spodnje plošče pod voziščem pa je 6,18 m pod spodnjo koto pokrova tj. cca. 12,00 m pod niveleto Celovške ceste. Svetla širina profila je cca 9,10 m in se prilagaja meram obstoječe galerije in zahtevam svetlega profila v avstrijskih oz. naših smernicah.

Relativno enostavna konstrukcijska rešitev pokritega vkopa, se je v fazi izvedbe izkazala za izredno učinkovito metodo, ki omogoča hitre napredke del, majhno število delovnih faz in kar je najpomembnejše hitro prestavitev Celovške ceste v prvotno stanje.

#### 4.2 Opis konstrukcije objekta

Objekt je v grobem razdeljen v dve ločeni enoti. Prva, daljša poteka od obstoječe galerije Šentvid na stacionaži km 0.9 + 11.70 do kolesarske steze, južno od Celovške ceste, druga faza pa poteka od Celovške ceste do vstopa v rudarski del predora na km 1.0 + 80.00. Skupna dolžina vkopa je cca. 168,60 m (odvisno od izbrane osi) in v večjem delu poteka med rahlo razmaknjenima uvozno izvoznima rampama za avtocesto.

Kot je bilo že omenjeno v prejšnjem poglavju, gre konstrukcijsko za dvoladijsko okvirno konstrukcijo. Zgoraj ležeči pokrov, debeline od 80 do 90 cm, leži na srednji vrsti pilotov in je preko robnega venca višine 130 cm togo vpet v stranski vrsti pilotov. Pokrov poleg vertikalne obtežbe vsled nasutja prevzema tudi tlačne osne sile vsled razpiranja stranskih pilotov ob izkopu pod pokrovom. Okvir pod voziščem zapira talna plošča debeline 50 cm, ki je togo vpeta v stranske pilote. Vsi piloti so vpeti najmanj 3 m v trdo hribinsko podlago meljevih skrilavcev. Zaradi zagotovitve ustreznega svetlega profila, ob majhni osni razdalji predorskih cevi, so sredinski piloti premera 80 cm zgoščeni na razstoj 150 cm. V južnem delu, po prehodu Prušnikove ulice, se osna razdalja poveča, zato so na teh mestih izvedeni piloti premera 100 cm. Vsi stranski piloti so premera 100 cm na razstoj 200 cm. Prostor med slednjimi je neposredno ob izkopu zaščiten z armiranim brizganim betonom v plitkem loku tako, da se celotna obremenitev zaledne hribine prenaša na AB pilote.

#### 4.3 Tehnični podatki

Niveleta cestišča in AB pokrova potekata višinsko vzporedno in sledita prehodnemu radiju iz vzdolžne preme v konstanten naklon 2,2%.

Velikost prečnega prereza vkopa je določena z definiranim svetlim profilom po avstrijskih smernicah RVS za cestne predore, le na stiku z obstoječo galerijo, je zaradi drugačne konstrukcijske zasnove galerije Šentvid bilo potrebno zmanjšati svetli profil na še sprejemljivo svetlo mero. Širina vozišča znaša 7,50 m, z dvema voznima pasovoma širine 3,50 m in obojestranskima robnima pasovoma širine 0,25 m. Vertikalna višina voznega svetlega profila znaša 4,70 m.

Zaradi vzdrževanja in nujnih primerov, sta na vsaki strani vozišča predvidena hodnika, ki sta 0,15 m dvignjena nad površino ceste, z nagibom 2 % proti vozišču. Najmanjša pohodna dvignjena širina hodnikov je 1,10 m, prosta višina pa 2,0 m. Svetli profil nad hodnikom je sestavljen iz varnostnega pasu 0,30 m ter 0,70 m širokega pasu višine 2,0 m.

Z upoštevanjem horizontalnega radija trase je določen najmanjši prečni sklon vozišča, ki znaša 2,5 %. Višina nad in poleg svetlega profila zadošča za namestitev prezračevalnih naprav in osvetlitve predora.

#### Normalni PP v pokritem vkopu Šentvid

vozna pasova	2 × 3.50 m	7.00 m
robni pas	2 × 0.25 m	0.50 m
zunanj vzdrževalni hodnik		min 0.85 m
notranji vzdrževalni hodnik		min 0.75 m
<b>SKUPAJ</b>		<b>9.10 m</b>

Slika 4-1: Prečni prerez pokritega vkopa

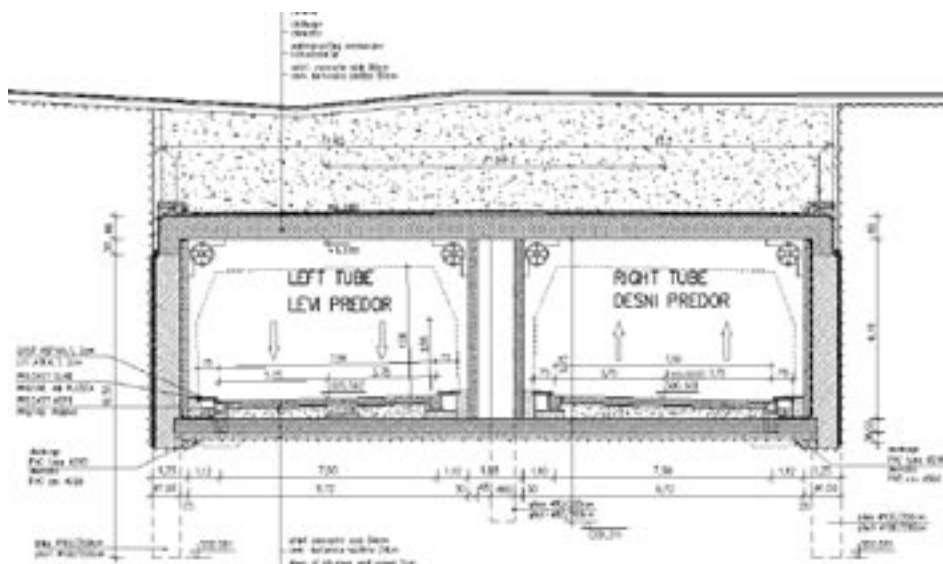

#### 4.4 Geotehnične osnove

Med izkopom se je izkazalo, da je bila geomehanska predikcija ustrezno načrtovana. Relativno heterogeno območje je bilo sestavljeno iz vrhnjega sloja umetnega nasutja iz apnenčevega proda z oglatimi kosi betona v peščeni do glinasti matrici ter kvartarnih sedimentov na neprepereli hribinski osnovi. Kvartarne sedimente sestavlja rjavo siva meljasta glina z nekaj oblimi delci skrilavca, melja in kremenčevga peščenjaka ter rjav zaglinjen do meljev prod s permokarbonskimi delci (skrilavec, melj in peščenjak). Vsi našteti materiali so zelo heterogeno razporejeni, zato so iz praktičnih razlogov bili upoštevani za geološko enotne.

Trdo hribinsko podlago predstavlja temno siva do črna masivna glina, melj in zaglinjen skrilavec z dodatkom od nekaj mm pa do več m debelim slojem drobnozrnatega permokarbonskega peščenjaka. Na območju južno od Celovške ceste je bila na globini cca. 15,00 m zabeležena močno tektonizirana plast hribine.

Debelina zgornjih dveh slojev se zmanjšuje proti jugu. Večji del objekta se nahaja v območju teh dveh slojev in je globoko temeljen v območje nepreperle hribine, le na območju Celovške ceste zasledimo hribinsko podlago že v območju izkopa.

Večji del podtalne vode se lokalno preceja med posameznimi zaglinjenimi plastmi kvartarnih sedimentov. Skupno takšen lokalni pritok na konstrukcijo ni presegal 1 l/s na posamezno lokacijo. Opaziti je bilo, da gre večinoma za odvajanje meteorne vode iz Šentviškega hriba. Višina stalne podtalnice je bila ugotovljena na koti 290,0 m n.m., kar je pod projektirano talno ploščo predorske cevi.

#### 4.5 Izvedba

Gradnja vkopa je potekala v sledečih fazah gradnje:

- Predhodna dela (planiranje delovnega platoja ter izvedba prvih pilotov)
- Prestavitev uvozne izvoznih klančin
- Izkop do spodnje kote pokrova in varovanje gradbene jame do Prušnikove ulice

- Prestavitev Celovške ceste
- Izvedba AB pokrova in podhoda 3-1 s spremljajočim izkopom vzdolž trase
- Vračilo celovške v prvotno stanje
- Izkop pod AB pokrovom

#### 4.5.1 Predhodna dela

Pilote se je izvajalo sukcesivno v smeri sever-jug, pri čemer je bila sprva izvedena sredinska vrsta pilotov do podhoda Prušnikove ulice, nato pa se je k izvedbi pristopilo z dvema garniturama za izvedbo stranskih vrst pilotov. Izvajalec je izvedel pilote 1 m nad koto spodnje površine pokrova, ostali jalovi del izkopa pa zapolnil s prepustnim materialom. Piloti so bili izvedeni po Benotto tehnologiji, ki je omogočala hitre napredke v območjih kvartarnih sedimentov in nekaj težavnejši izkop v hribinski podlagi.

Dolžina pilotov se spreminja glede na geološko situacijo in geometrijo objekta, v splošnem pa se dolžine pilotov krajšajo od galerije (20 m) proti Celovski cesti (10 m). Vsi piloti imajo minimalno vpetost v podlago 3 m, v območju nizkih plasti sedimentov pod Celovško cesto, pa tudi več.

Izvedbena toleranca pilotov je na površini +/- 2 cm v vsako smer in na dnu 1% globine izkopa. Vsled zaglinjenosti materiala, se je izkazalo, da premer pilotov bistveno ne presega projektirane vrednosti.

#### 4.5.2 Varovanje gradbene jame

Za potrebe izvedbe pokrova se je izvedel izkop gradbene jame v območju med obema rampama. Zaradi prostorske stiske je bilo potrebno izvesti začasno varovanje gradbene jame. Namesto berlinskega zidu z vgradnjo jeklenih profilov v pilote po PZR projektu, se je izvajalec odločil pristopiti k uporabi sidranih zagatnih sten z zabitimi jeklenimi profili. Ta način izvedbe je omogočal še boljšo izrabo prostora med objektom in uvoznima rampama. Globina potrebnega izkopa se je gibala med 3,8 m in 5,9 m ob Celovski cesti. Večji del zagatne stene je bil sidran pod klančinama v temelje obstoječega opornega zidu oz. v kontra zagatne stene.

Sidranje je bilo izvedeno s sistemom DOKA schalungankersystem s sidrne matice na predhodno privarjena profila UNP 240.

#### 4.5.3 Izvedba AB pokrova

Talna površina pokrova je predhodno komprimirana do 95% po Proctorju in naknadno izravnana s podložnim betonom MB15. Za boljši končni izgled so bile za opaženje uporabljene vezne opažne plošče, ki so bile kasneje ob izkopu enostavno odstranjene in obnovljene.

Pred betoniranjem so bile glave pilotov premazane s polimernim cementnim hidroizolacijskim slojem debeline, ki onemogoča prehod vlage v predorsko cev.

Zgornja površina betonskega pokrova je izvedena v naklonu, nanj je pritrjena PVC folija debeline 2,0 mm in je zaščiten s slojem armiranega povoznega betona. Hidroizolacija se konča pod robnim vencem, kjer je predvidena vzdolžna drenaža.

Betoniranje je potekalo po kampadah dolžine 23,60 m. Navidezne rege so predvidene na razdalji 5,0 m. Na mestu podhoda za pešce na Prušnikovi cesti se predvidi

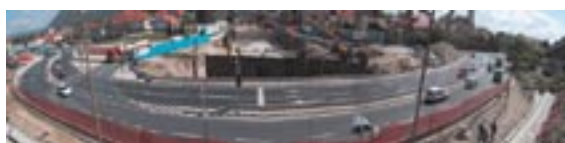

Slika 4-2: Faze gradnje pokritega vkopa

delovni stik za stene opornika podhoda.

Ob prestavljeni Celovški cesti je izveden kolenčna stena višine cca. 3,0 m za prevzem zemeljskih pritiskov zasutja Celovške ceste.

#### 4.5.4 Izkop pod pokrovom

Priprave na izkop so se pričele izvajati v skladu z napredovanjem del na površini. Ob zasutju prvih kampad pokrova so se pričela pripravljala dela za izkop in rušitvena dela za odstranitev čelne stene ob koncu galerije.

V razpisni dokumentaciji je bilo predvideno sprotno razpiranje pilotov na najnižji koti izkopa, vendar smo z implementacijo strogega programa geotehničnih meritev pomikov, dopustili zamudno izvajanje betonerskih del.

Meritve so vključevale dnevna spremljanja zadnjih treh merskih profilov pred čelom izkopa, dvakrat tedensko merjenje profilov na oddaljenosti 30 m od čela izkopa in enkrat tedensko za profile do oddaljenosti 50 m od čela izkopa. Meritve ostalih profilov so potekale enkrat na dva tedna. Tudi po zaključku izkopa do konca gradnje, je bilo potrebno meritve izvajati enkrat tedensko na izbranih profilih. Ob morebitnih kritičnih pomikih bi bilo potrebno uvesti sprotno razpiranje s talno ploščo dokler bi izkop potekal v slabših geomehanskih pogojih.

Izkop v desni cevi je sledil izkopu v levi cevi ali obratno, z maksimalnim zamikanjem čela izkopa 10 m. Torej je bila dolžina koraka napredovanja maksimalno 20 m na posamezno cev.

Neposredno po izkopu je bilo potrebno v prostor med piloti v stranski steni vstaviti vertikalno drenažno cev in zavarovati površine pred zasutjem s plastjo brizganega betona.

Po izvedenem izkopu so se izvajala vsa zaključna dela vzporedno z inštalacijami in betonerskimi deli.

## 5. Raziskovalni rov

### 5.1 Uvod in osnovni razlogi za odločitev izvedbe

Trasa predora poteka skozi večjo sinklinalno gubo permokarbonskih plasti, razkosano z narivanjem lusk in premiki ob subvertikalnih prelomih, zato je hribina, ki je v grobem sestav klastičnih permokarbonskih skrilavih glinovcev, meljevcev in peščenjakov, večinoma razpokana in na mestih močno pretrta oziroma tektonizirana.

Ker raziskovanje s površja, z namenom iskanja optimalne lokacije, ne daje zadovoljujočih rezultatov, je bila odločitev o izvedbi raziskovalnega rova samoumevna z gledišča zahtevnosti izgradnje in umestitve priključne kaverne ter pestrosti geološke sestave Šentviškega hriba. Dodatno so se v rovu med izkopom izvajale geološko-geomehanske raziskave, od tod imenovanje raziskovalni rov oz. predor (v nadaljevanju RP).

Vse predikcije in projektne rešitve v predorogradnji vsebujejo neko stopnjo tveganja. Z izvedbo RP smo sicer težje opravičljivimi stroški zmanjšali stopnjo tveganja, saj zaradi poznavanja hribinske mase:

- Izdelamo natančnejše projekte z boljšo predikcijo
- popisi del in s tem ponudbena in izvedbena cena je znana
- zmanjšanja se tveganje pri gradnji
- zmanjšanja se tveganje nekontroliranega naraščanja stroškov
- izvajalec se lahko pripravi, saj v vsakem koraku natančno ve kaj pričakuje

Dela na rovu so bila razčlenjena na tri dele in sicer:

- gradbena dela na izkopu
- geološke raziskave v rovu in s površja
- kontinuirno geološko kartiranje in dnevna geomehanska spremljava pomikov in njihova interpretacija

#### 5.2 Opis zasnove

Trasa rova je zasnovana z namenom zagotoviti optimalno lokacijo kasneje zgrajene kaverne ter zagotoviti čimveč podatkov in meritev na bodoči trasi predora. Portal na vznožju Šentviškega hriba je lociran tako, da nima vpliva na začasni obvoz Celovške ceste in izgradnjo začasne oporne konstrukcije, hkrati pa zagotavlja dovolj prostora za namestitev potrebnih inštalacij in omogoča enostaven dostop do javnega cestnega omrežja za odvoz izkopnega materiala.

Rov je po dolžini razdeljen na tri dele in sicer:

Dostopni rov služi za povezavo med portalom in rovom, ki poteka v trasi desne osi bodoče avtoceste. Ta del rova v dolžini 90m poteka v premi z vzdolžnim sklonom ca. 12% in 0% prečnega nagiba.

Desni rov je namenjen ugotavljanju optimalne lokacije kaverne v desni cevi. Poteka v trasi desne osi bodoče avtoceste. Dolžina rova v radiju 1500 m znaša 475 m, vzdolžni sklon 2.2% ter prečni nagib 0%.

Levi rov je namenjen ugotavljanju optimalne lokacije kaverne v levi cevi, poteka pa po trasi leve osi bodoče avtoceste. Dolžina rova v radiju 1500 m znaša ca. 252 m z enakim vzdolžnim in prečnim sklonom kot v desnem rovu. Na desni rov se navezuje preko prečnega povezovalnega rova dolžine 40 m.

Slika 5-1: Situacija rova

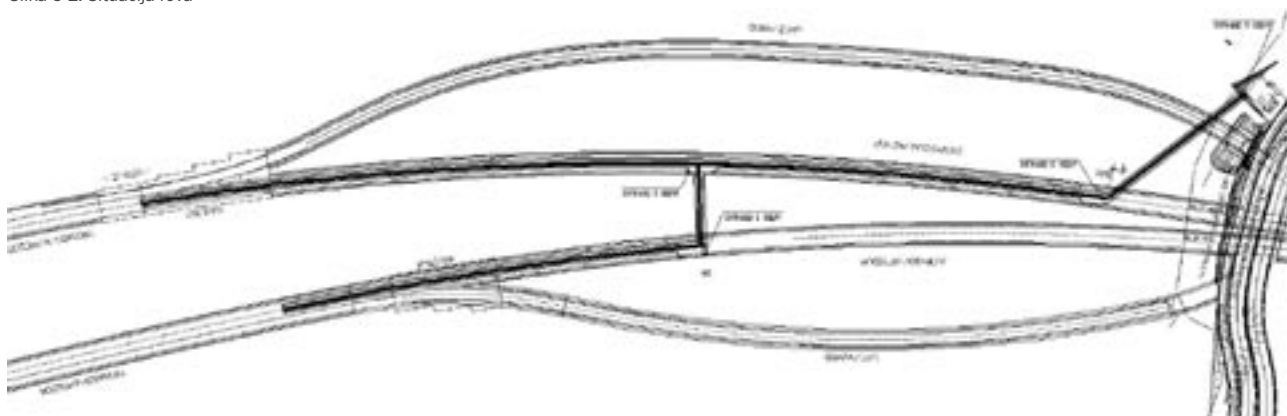

Trasa raziskovalnega rova z razpisom ni bila fiksno določena, temveč je bila odvisna od trenutnih geoloških razmer in zahtev po izvedenih raziskavah. Glede na rezultate izvedbe lahko trdimo, da se je izvajalec prilagodil zahtevam naročnika in spremenil traso izkopa skladno s potrebnimi raziskavami.

Velikost prečnega prereza raziskovalnega rova (ca. 13 m<sup>2</sup>) je določena s potrebnim svetlim profilom za namestitev in uporabo predorske gradbene opreme. Velikost profila je prav tako zadostna za obratovanje predorskega prometa in stransko namestitev transportne poti za izkopni material. Razširjeni prečni prerezi (ca. 25 m<sup>2</sup> oz 50 m<sup>2</sup>) so mesta namenjena geološko-geomehanskim raziskavam.

Slika 5-2: Geometrija izkopa za varianto s in brez talnega oboka

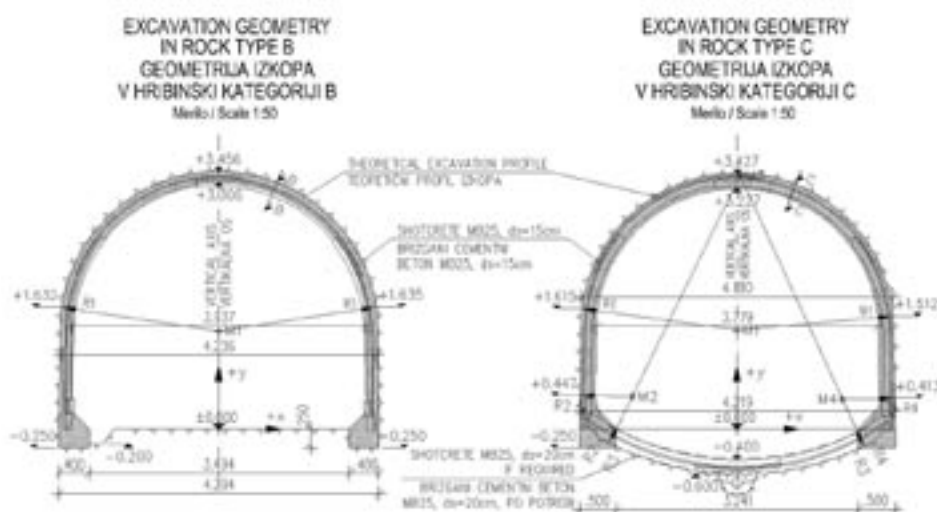

### 5.2.1 Geomehanski pogoji izgradnje

V grobem je izkop razdeljen na dostopni rov in rov znotraj trase predora. Dostopni rov poteka v plitkem kotu glede na severno pobočje Šentviškega hriba, zato večinoma poteka v zaglinjenem pobočnem grušču, ki je mestoma podvržen izpiranju meteorske vode in v delno tektonsko pregnetenem glinovcu. Ob spuščanju rova do trase se pojavijo plasti drobnozrnatega peščenjaka, ki preide v tektonsko cono. Zaradi pestre sestave geomehansko neugodnih plasti in majhnega nadkritja hribino uvrščamo v PC kategorijo po ÖNORM 2208.

Na območju trase predora, izkop poteka večinoma v plasteh sivega peščenjaka, muljevca, skrilavega glinovca in delno preko tektonskih con. Razen v tektonskih conah izkop poteka v hribinski kategoriji A in B. C kategorija se uporabi na prehodih skozi tektonsko cono, kjer voda na kontaktu med razpokami zapolnjenimi z tektonsko glino z izpiranjem povzroča padec kohezije. Zato večinoma pretir in vodonosen skrilavi meljevec v zgornjih slojih kaže znake težnostnega rušenja iz stropa izkopnega profila.

### 5.3 Opis načina gradnje

Rov se gradi v skladu s principi in filozofijo NATM (New Austrian Tunneling Method), kar pomeni, da se podporje predora prilagaja dejanskim geomehanskim pogojem gradnje. Običajni principi nove avstrijske metode predvidevajo sidranje ostenja

in krone stropa predorske cevi, s čimer se zagotovi kontinuiteto zaledne hribinske mase in se onemogoči bistven vpliv razpok, skrivilavosti ali drugih vrst geomehanskih nepravilnosti. Sidranje se izvede v tolikšni meri, da se zagotovi zadostna debelina zalednega loka hribine. Ustreznost sheme sidranja pa se med gradnjo nenehno preverja z merjenjem konvergenca pomikov betonske lupine.

Zaradi kasnejše izvedbe dvo in tro pasovnega predora ter kaverne na trasi rova, je bilo smiselno zagotoviti čim manjšo razrahljanje hribinske mase v zaledju bodočega profila. V ta namen je predvideno omejevanje pomikov betonske lupine, z izvedbo talnega oboka in prenapenjanjem matic na sidrnih glavah.

Izkop se izvaja v štirih kategorijah prirejenih standardnim kategorijam A, B, C in PC (portalna kategorija), ter izredni kategoriji za izkop v židki hribini.

Slika 5-3: Tipičen primer podpiranja rova

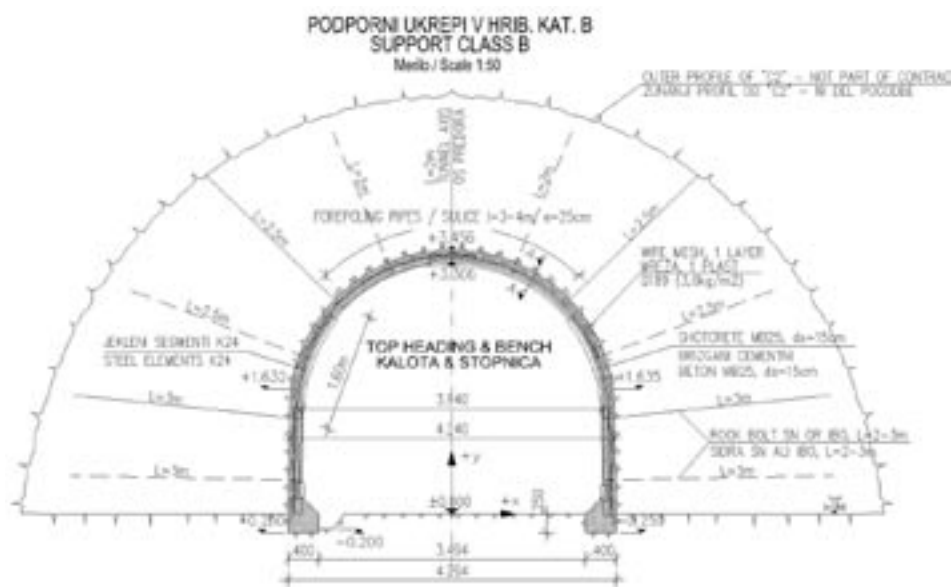

Gradnja rova poteka v treh fazah in sicer:

- ukrepi pred čelom izkopa
- izkop
- podpiranje

Odvod izkopenine se, zaradi majhnega profila izvaja s pomočjo verižnega traku in transporterja z gumijastim trakom.

Tekom izgradnje rova se je v prakso uvedla uporaba mikroarmiranega brizganega betona, predvsem za razlogom zmanjšanja števila gradbenih faz in posledično lažjega obvladovanja in hitrejšega napredovanja del. Z uporabo mikroarmiranega betona se je opustila uporaba sidranja in armiranja z armaturnimi mrežami. Sidranje se je izvajalo samo v primeru, ko so nato kazale dnevne meritve konvergenca.

#### 5.3.1 Ukrepi pred čelom izkopa

Za varnost in stabilnost izkopa se je na določenih lokacijah izvajalo predhodno dreniranje čela z vstavitvijo perforiranih cevi z zatesnjenim ustjem. Na ta način se je



učinkovito odvajala voda, hkrati pa je bilo preprečeno izpiranje tektonskih delcev iz razpok in posledično padca kohezije.

V smislu predhodnega podpiranja izkopa se v stropni del čela nad jeklenim ločnim podporjem vgrajujejo sulice pod plitkim kotom. To so bodisi jeklene palice vgrajene v cementno malto ali pa samouvrtana sidra. Med sulicami se ustvari začasen obok hribinske mase, ki preprečuje lokalno izpadanje, pri čemer sulice služijo v oporo peti oboka. Hkrati se s tem ukrepom zaščiti delavce pri postavljanju primarnega podporja. V izjemnih primerih židke hribine se namesto sulic vgrajujejo jeklene deske, redko jih lahko nadomestijo hrastovi plohi.

### 5.3.2 Izkop in podpiranje

Vsled slabših geomehanskih pogojev izkopa se izvaja izkop in podpiranje v večih fazah. Izkop poteka v sledečih fazah:

- izkop čela predora
- varovalni kontaktni obrizg odprtih površin debeline 3-5 cm, za zatesnitev in preprečitev izpiranja
- vgradnja stropnega loka jeklenega podporja
- vgradnja armaturne mreže nad jekleno podporje
- vgradnja brizganega betona do projektirane debeline

Če se izkopno čelo razdeli na fazo kalote in stopnice, se celoten postopek izvede v dveh korakih, najprej za kaloto in nato sledi stopnica. Podoben redosled se uporabi pri izkopu talnega oboka, le da se sprva položi armaturno mrežo, čemur sledi vgradnja jeklene loka in obrizg v celotni projektirani debelini.

Po končanem obrizgu se vgradi po projektni shemi predvidena hribinska sidra, bodisi SN (jeklene palice) ali IBO samouvrtana sidra.

### 5.3.3 Uporabljeni podporni elementi

Osnovni podporni elementi po NATM so:

- Brizgani cementni beton se uporablja za preprečitev rahljanja hribine na čelu izkopa, obloga zapre razpoke v hribini, prepreči izpadanje hribine in s tem zruške. Uporablja se suhi postopek nabrizgavanja, pri čemer je na gradbišče dostavljeni mešanici cementa in agregata dodana voda neposredno pred brizgalno šobo v rovu. Dodatki za strjevanje se dodajajo suhi mešanici in neposredno na gradbišču, odvisno od rezultatov preiskav neposredno na izkopu. Debelina obloge je odvisna od hribinske kategorije in sicer 10, 15 ali 20 cm za A, B in C.
- Armaturne mreže izboljšajo strižno in natezno nosilnost brizganega betona. Uporablja se mreže Q189, na vsakih 10 cm brizganega betona se uporabi ena plast mreže.
- Sidra se vgrajuje sistematično, kot del standardnega podpornega sistema. V rovu se vgrajuje samouvrtana IBO sidra z izgubljen krono in drogom, ki se jih naknadno zainjecira in jeklene palice, SN sidra, ki se jih vgrajuje v predhodno zavrtano in injecirano vrtino. Slednje se uporablja samo v primeru, da to hribina dopušča. Vrtanje se izvaja z ročnim vrtalnim strojem in podporno lafeto.

- Jekleni loki primarno služijo kot začasni podporni element in omogočajo varno delo na čelu predora. V rovu se uporabljajo loki tipa K24, ki hkrati omogočajo rudarski transport po stropu predora.
- Začasni podporni elementi kot so injekcijske sulice (cevi) in jeklene deske

#### 5.4 Spremljava

Med gradnjo predora se izvaja striktna geološka in geotehnična spremljava z namenom pridobivanja ključnih podatkov za kasnejšo izvedbo predora Šentvid.

##### 5.4.1 Geološka spremljava

Izvaja se neprekinjena geološka spremljava, kartiranje, nadzor, izdelovanje modela ter poročanje. Med gradnjo rova je nepretrgoma razpoložljiv geolog. V nočnem obdobju je geolog razpoložljiv v kratkem času po klicu na mobilni telefon. Redno se izvaja kartiranje in fotografiranje čela izkopa. Prav tako se redno izvaja nadzor in geotehnična spremljava.

Prav tako potekajo kratki dnevni in tedenski sestanki za načrtovanje in koordiniranje raziskovalnega vrtanja, vzorčenja, preiskovanja in geofizičnih raziskav.

##### 5.4.2 Geotehnična spremljava

Tekom izvedbe rova se v skladu z NATM izvajajo meritve konvergence izkopnega profila. Meritve izvaja izvajalec, obdelava in interpretacija pa je prepuščena projektantu predora. Obdelava se izvaja s programskim paketom »TunnelMonitor«, ki omogoča številne interpretacije in kombinacije dnevno dostavljenih podatkov. V sklopu obdelave so bile izvršene sledeče naloge:

###### a) Grafični prikaz meritev deformacij zajema izračun 3D koordinat in pomikov izbranih točk in sicer za sledeče izbrane postavke:

- Diagram stanja merjenega parametra vzdolž rova (vplivnice)
- Diagrami časovnega razvoja merjenih parametrov v posamezni merski točki
- Diagram deformacij v prerezu (vektorski diagram)
- Prikaze časovnega razvoja merjenih parametrov v merskem profilu v odvisnosti od oddaljenosti od izkopa kalote
- Prikaze časovnih razvojev merjenih parametrov v odvisnosti od oddaljenosti merskega profila od izkopa čela
- Prikaze časovnih razvojev merjenih parametrov v odvisnosti od oddaljenosti merskega profila glede na različne faze del v predoru

V zgoraj navedenih diagramih so predstavljeni sledeči parametri:

- Relativne deformacije med katerimakoli merskima točkama
- Komponenta oz. katerakoli izpeljana komponenta parametra (vertikalna, horizontalna komponenta pomikov)

###### b) Ovrednotenje in interpretacija geotehničnih meritev

- Ovrednotenje in interpretacija meritev deformacij
- Ovrednotenje in interpretacija deformacij (posedanje) na površju vzdolž trase rova
- Ovrednotenje in interpretacija meritev deformacij na objektih.

- Ovrednotenje in interpretacija meritev kompleksnih merskih profilov (npr. ekstenzometer, mersko sidro).

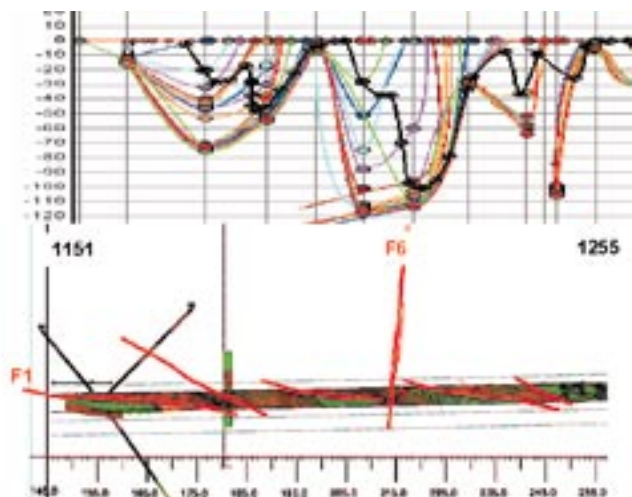

Slika 5-4: Tipičen primer interpretacije rezultatov

Interpretacije se dnevno usklajujejo z geološkim modelom in posredujejo naročniku v pregled. Rezultati služijo za optimiranje podpornih ukrepov in delovnih faz ter za verifikacijo uporabljene hribinske klasifikacije.

Za kontrolo deformacij zaledne hribine okrog predorske cevi bodo uporabljene merske naprave v obliki preciznih merskih trakov ali optična elektronska oprema. Za ugotavljanje prostorskih pomikov ostenja predorske cevi se uporabi normalni elektronski tahimeter (distomat). Merske točke morajo biti opremljene z optičnimi prizmami oz. drugimi ustreznimi točkami. Meritve deformacij bodo izvedene v glavnih ceveh raziskovalnega rova vključujoč povezovalni rov.

## 5.5 Raziskave terena

Tekom gradnje in po končanju gradbenih del so predvidena intenzivna raziskovalna dela na površju in znotraj rova. Dela so razdeljena na sledeče postavke:

- Udarno vrtanje (predvideno v sklopu predvrtavanja z namenom ugotavljanja nadaljnjega poteka rova)
- Rotacijsko sondažno vrtanje s površine in znotraj rova za potrebe izvedbe in-situ in laboratorijskih preiskav ter splošno izboljšanje geološkega modela
- Vzorčenje zajema odvzem porušnih in intaktnih vzorcev za nadlajjno uporabo
- In-situ preiskave zajemajo preiskave s krilno sondo v vrtini, preiskave deformacijskih karakteristik z obremenilno ploščo (plate load test) na vodoravnem terenu na katerikoli lokaciji v raziskovalnem rovu, presiometerske preiskave po Menardu v sondažni vrtini, itd.
- Laboratorijske preiskave
- Geofizikalne preiskave terena

Vsa dela so podvržena navodilom naročnika, v razpisu pa je podan samo okvirni program preiskav za predvideno vrednost del. Dejanski razpored del določa Geotehnični svet na rednih tedenskih sestankih, ki je sestavljen iz oredstavnikov naročnika, izvajalca geološke spremljave, projektanta predora in nenazdanje zunanje kontrole.

## 6. Glavni del predora

### 6.1 Uvod

Kot je bilo povedano že v uvodnem poglavju je glavni del predora razdeljen na štiri delov in sicer gledano v smeri stacionaže trase:

- dve dvopasovni cevi,
- dve kaverni,
- dve tropasovni cevi (dva glavna vozna pasova z zaviralnim/pospeševalnim pasom)

- dve priključni cevi (desna enopasovna z dodatnim odstavnim pasom, leva sprva enopas, ki se razširi v izhodu na dva pasova)

V prispevku se bomo osredotočili na bistvene tehnične značilnosti predora, saj je predor še v fazi projektiranja.

#### 6.2 Trasa predorske cevi

Projektirana trasa je odvisna od dejanske geološke situacije, ki pa se z izkopom rova nenehno dopolnjuje. Predstavljena trasa ustreza geološkim podatkom znanim na dan razpisa. Danes že lahko trdimo, da se bo dejanska trasa v precejšnji meri razlikovala od razpisane, predvsem v smislu dolžin posameznih sklopov.

Projektirana dolžina vseh cevi v rudarskem izkopu je cca. 3148.

##### 6.2.1 Glavni cevi

Cev poteka od km 1.0 + 80.00 do km 2.1 + 40.00:

- maksimalna nadmorska višina na južnem portalu 325,856 m
- vzdolžni sklon: 2.2 %
- prečni sklon vozišča: 2.50 %
- minimalni horizontalni radij: 1500 m

Dejanska dolžina obeh glavnih cevi znaša 2120.00 m (merjeno po osi predora).

##### 6.2.2 Priključni cevi

Obe priključni cevi se pričneta na višjem nivoju in sledita vzporedno glavni trasi do priključka, ki se ga natančno locira s smernim raziskovalnim rovom. Za priključni rampi je bila določena ločena stacionaža. Rampi se pričneta z odcepom iz Celovške ceste, prečkata podvoz/podhod za pešce in kolesarje in vstopita v rudarski del predora. Niveleta ceste se sprva dviga v minimalnem, še dopustnem naklonu (0,5%), nato pa se v istem naklonu spusti do priključka z glavno cevjo.

Karakteristike trase:

- maksimalna nadmorska višina na prevoju 317.188 m, višina na portalu Šentvid 316.017 m, višina v priključni kaverni 315.866 m
- vzdolžni sklon: min 0,5 %
- prečni sklon vozišča: 2.50 – 4.00 %
- minimalni horizontalni radij: 200 m

Predvidena dolžina priključne cevi znaša 1028 m. Dejanska dolžina bo določena po izvedbi raziskovalnega rova.

##### 6.2.3 Portali

Običajno dvocevni predori premorejo dva portalna useka, v skrajnih primerih štiri useke na dveh portalnih območjih. Predor Šentvid na celotni dolžini premore kar pet portalnih območij in sicer:

- severno portalno območje v bližini naselja Brod,

- začasni rudarski portal v Šentvidu,
- južno portalno območje v Pržanju
- ter dva portalna useka v Šentvidu za priključni cevi

Na severnem portalu se bodo izvajala samo dela na opremi predora.

### Portal sever

Končni portalni vhod je predviden na severnem vhodu v galerijo Šentvid. Za preprečitev prehoda dima med predorskima cevema je potrebno že obstoječo vmesno AB steno podaljšati za 20 m. Vsa ostala potrebna gradbena dela za doseg ustreznih karakteristik portala in celotne galerije Šentvid niso del tega projekta.

### Začasni rudarski portal Šentvid za glavni cevi

Začasni severni portal za rudarski izkop dvopasovnega dela glavnega cevi bo lociran znotraj veznega pokritega vkopa.

Portalna konstrukcija na severnem delu omogoča vezni prehod iz že izvedenega pokritega vkopa Šentvid v rudarski del predora. V tem delu se prav tako izvede prehod iz dvoceličnega pravokotnega profila v dva ločena cilindrična profila. Za doseg čimbolj ekonomično rešitve in v izogib morebitnim stabilnostnim problemom v brežini nad portalom, je bila izbrana konstrukcija zaprtega tipa namesto predhodno predlagane varovane gradbene jame.

Dostop do začasnega portala je urejen skozi stransko klančino za povezavo z gradbiščnim platojem, in čelno skozi že izvedeni del pokritega vkopa Šentvid. Stranska klančina se varuje klasično z AB uvrtnimi koli in jeklenimi razporami, pritrjenimi na razporno gredo vrh kolov. Klančina se po končanju del sanira v prejšnje stanje, na vhodu v portalno konstrukcijo pa se izvede stranska AB stena, temeljena na AB kolih in pilotni gredi.

### Portal jug

Zaradi možnosti aktiviranja fosilnih plazov na območju južnega portala (geološko – geomehansko poročilo, ZAG, 2000) je bil na predlog geologa (ZAG), zasnovan izkop v območju portala s čim manjšim poseganjem v hribinsko maso raščenege terena. Za pričetek rudarskega izkopa predora smo predpostavili kriterij minimalnega nadkritja cca. 2 m.

Arhitekturni pogoji določajo enotno portalno območje tj. portala obeh cevi predvideti v istem profilu, posledično je potrebno zagotoviti isto višino obeh začetnih profilov.

Medosna razdalja predorskih cevi na južnem portalu znaša 40 m. Za preprečitev prehoda požarnega dima iz ene v drugo cev je predvidena izgradnja vmesnega nasipa v skupni dolžini 40 m.

Stranske in čelne brežine portala so klasično stabilizirane pod kotom 30° in zaščitene s 15 cm debelo plastjo brizganega cementnega betona, plastjo armaturne mreže Q189 in IBO sidri kapacitete 250 kN, dolžine 6m in gostote 1 sidro/4 m<sup>2</sup>. Končna oblika in zaščita zatravljenih brežin se izvede z geotekstilom v plasteh po 30 cm.

#### Portalna useka Šentvid za priključne cevi

Portalni usek za desno priključno cev se izvede neposredno ob portalu Raziskovalnega rova. Trasa priključne rampe na tem delu seka sidrano oporno konstrukcijo za prestavitev Celovške ceste, zato bo potrebno na tem delu odstraniti skrajni dve dilatacijski enoti omenjene konstrukcije. Gre za klasičen portalni usek s začasnim rudarskim portalom in oblikovno drznim končnim portalnim pokritim vkopom.

Portalni usek za levo priključno cev poteka pod negodnim kotom, glede na topografijo terena, zato je na tem delu predvidena večfazna izdelava useka. Rudarski izkop pa naj bi potekal pod zaščito pokritega vkopa.

#### 6.3 Prečni prerez predora

Velikost prečnega prereza predora je določena s svetlim profilom predora. Širina vozišča v dvopasovnem delu predora znaša 7,50 m, kar zadošča za dva vozna pasova širine 3,50 m z obojestranskima robnima pasovoma širine 0,25 m. Vertikalna višina svetlega profila znaša 4,70 m. Karakteristična prereza tropasovnega dela predora in priključne cevi sta bila načrtovana analogno dvopasovnemu. Tako širina vozišča v tropasovnem delu predora znaša 11,00 m, kar zadošča za tri vozne pasove širine 3,50 z obojestranskima robnima pasovoma širine 0,25 m. V primeru priključne cevi je predvideno vozišče širine 5,50 m od tega odpade 3,0 m na vozni pas, 2,0 na odstavni pas in 0,25 na obojestranska robna pasova.

	dvopasovni	tropasovni	priključna cev
Vozna pasova	2 × 3,50 m	2 × 3,50 m	1 × 3,00 m + 1 × 2,00 m
Robni pas	2 × 0,25 m	2 × 0,25 m	2 × 0,25 m
Vzdrževalni hodnik	2 × min 0,85 m	2 × min 0,85 m	2 × min 0,85 m
<b>SKUPAJ</b>	<b>9,20 m</b>	<b>12,70 m</b>	<b>7,20 m</b>

Slika 6-1: Tipičen prečni prerez v tropasovnem delu predora (prekinjena črta označuje silhueto dvopasovnega dela predora)

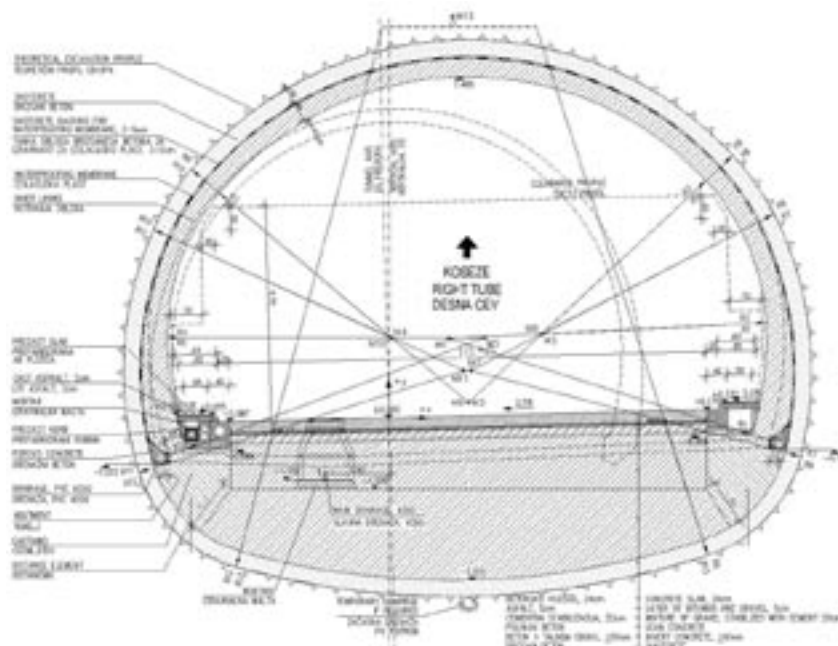

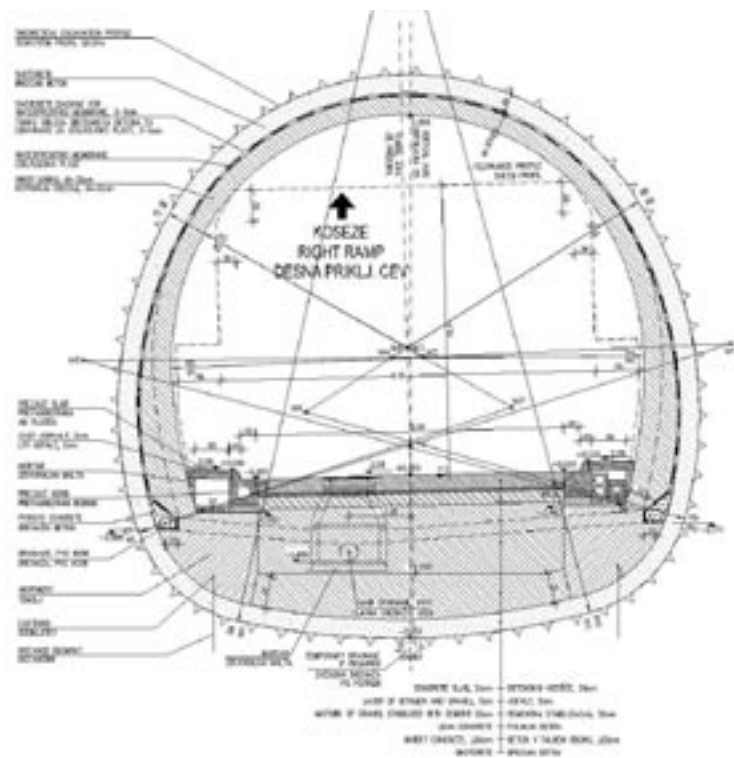

Slika 6-2: Tipičen prečni prerez v priključni cevi

## 6.4 Izkop predora

### 6.4.1 Splošno

Izkop predora bo potekal s pomočjo vrta-  
nja in miniranja ali z mehanskim izkopom (z  
rezalnim strojem ali kopačem).

Izkop predora je predviden iz južne strani  
glavne predorske cevi in severne strani pri-  
ključne in glavne predorske cevi. Dodatno  
napadno mesto bo vzpostavljeno za začetnih  
50 m izkopa priključne cevi iz kaverne. Izkop  
kaverne se vrši izključno iz glavne cevi pre-  
dora, pri čemer izkopna dela v glavni cevi ne  
smejo biti motena.

### 6.4.2 Klasifikacija hribin

Hribinska klasifikacija za potrebe izvedbe  
predora, je v splošnem osnovana na avstrij-  
skih standardih OENORM B 2203 (izdaja  
1994-10).

Ocenjena porazdelitev hribinskih kategorij je osnovana na geoloških, hidrogeolo-  
ških in geotehničnih raziskavah. Za posamezne dele predora so bile izbrane sledeče  
hribinske kategorije:

- Priključni cevi (B2, C2, C3 in PC)
- Dvopasovni del predora (B2, C2, C3 in modificirana PC)
- Tropasovni del predora (B2, C2, C3, SCC in modificirana PC s cementno stabiliza-  
cijo)

Izkopni profil je v splošnem razdeljen na kaloto, stopnico in talni obok ali pa na  
kaloto in stopnico. V nadaljevanju so opisani podporni ukrepi za zanimive, neobičajne  
odseke predora.

### 6.4.3 Izkop dvopasovnega predora v območju raziskovalnega rova

Ker rov deloma poteka v trasi dvopasovnega predora in prečka traso priključne  
cevi, je bilo predvideno zapolnjenje rova na vstopu v dvopasovni predor in pri prečka-  
nju priključne cevi. Zapolnjenje je predvideno izvesti s pustim betonom. Med izgrad-  
njo celotnega dvopasovne cevi je potrebno odstraniti in transportirati iz predora vse  
podporne elemente predhodno izvedenega raziskovalnega rova.

### 6.4.4 Izkop dvopasovnega predora na začasnem severnem portalu Šentvidu

Izkop dvopasovnega predora na severnem portalu se prične na stacionaži km  
1,0 + 79.62 pod AB pokrovom predhodno izvedenega pokritega vkopa na južni strani  
Celovške ceste. Izkop predvidoma poteka v portalni hribinski kategoriji, z nekaterimi  
dopolnitvami.

Prva delovna faza bo vgradnja cevnega ščita rudarskega dela predora. Zadnjih 3 m izvedbe plošče pokritega vkopa je potrebno izvesti hkrati z napredovanjem del na rudarskem delu predora (nanašnje brizganega betona med piloti, vgradnja drenaže in izvedba AB pokrova).

Pred betoniranjem zadnjega segmenta pokritega vkopa nad severnim portalnim območjem, se izvede prvi del cevnega ščita rudarskega dela predora. Po dokončanju

izkopskih del pod AB pokrovom se prične z izkopskimi deli na eni izmed predorskih cevi. Čelo sosednje cevi se zaščiti z armiranim brizganim cementnim betonom in hribinskimi sidri.

Izkop prve izmed cevi se izvršiti vsaj 100 m v globino, vključno z zapiranjem talnega oboka, predno se dovoli izvajalcu pričeti z izkopom. Primarna obloga predorske cevi se odebeli na 45 cm. Med izkopom druge cevi je potrebno oblogo obeh povezati s prečnimi IBO prednapetimi sidri. Bližina obeh cevi narekuje uporabo dodatnih podpornih ukrepov v skladu s hribinsko kategorijo, vsaj prvih 25 m izkopa.

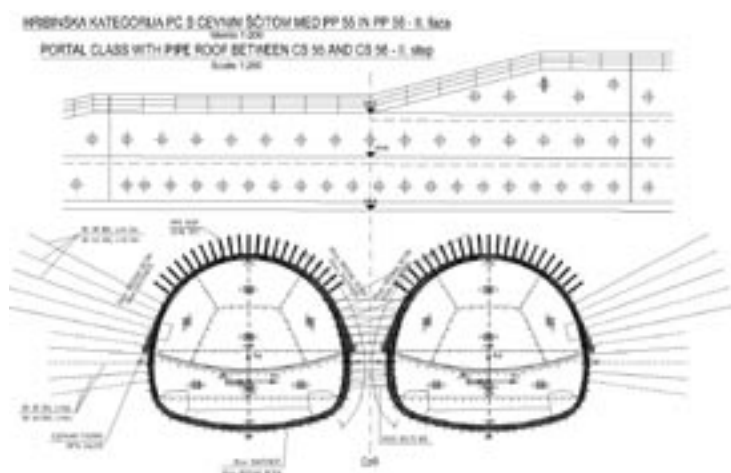

Slika 6-3: Izkop predora v območju začasnega severnega portala v Šentvidu

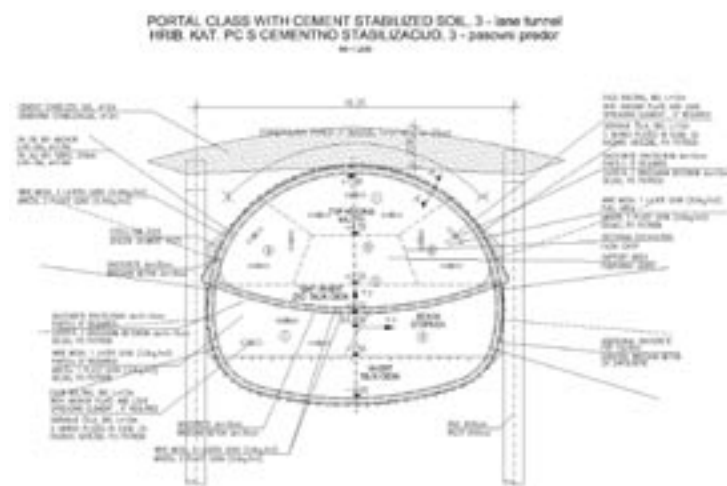

Slika 6-4: Izkop predora v območju južnega portala v Pržanju

#### 6.4.5 Izkop tropasovnega predora v območju južnega portala

Na delu južnega portala, kjer je predviden izkop predora v območju nizkega nadkritja, se v območju nevarnosti fosilnega plazusa stranske stene predhodno zavarujejo s pilotnimi vrstama. Ti služijo za stabilizacijo plazusa in za temeljenje notranje obloge s peto kaloto, s čimer preprečimo prekomerne posedke predorske cevi. Na delu, kjer nadkritje ne zadošča za konvencionalne načine izkopa je predvidena predhodna cementna stabilizacija krone predorske cevi. Kjer nadkritje zadošča minimalnim kriterijem, se uporabi hribinska kategorija za nizko nadkritje (SCC). Ostali podporni ukrepi ustrezajo hribinski kategoriji SCC oziroma PC.

#### 6.5 Izkop kaverne

Kaverno skupne dolžine 84 m torej tvorijo trije odseki dolžine 18 m in zadnji tranzicijski odsek dolžine 30 m. Leva stran profila kaverne v smeri vožnje steče enakomerno iz dvopasovne v tropasovno cev. Os desne strani profila kaverne pa stopenjsko v treh 3 - metrskih korakih in zadnjem 1,5 metrskem koraku preide v os desne strani tropasovne cevi. Največji profil kaverne doseže 24 m svetlega razpona in 15 m svetle višine. Točna lokacija kaverne se določi na podlagi izsledkov raziskav v raziskovalnem rovu.



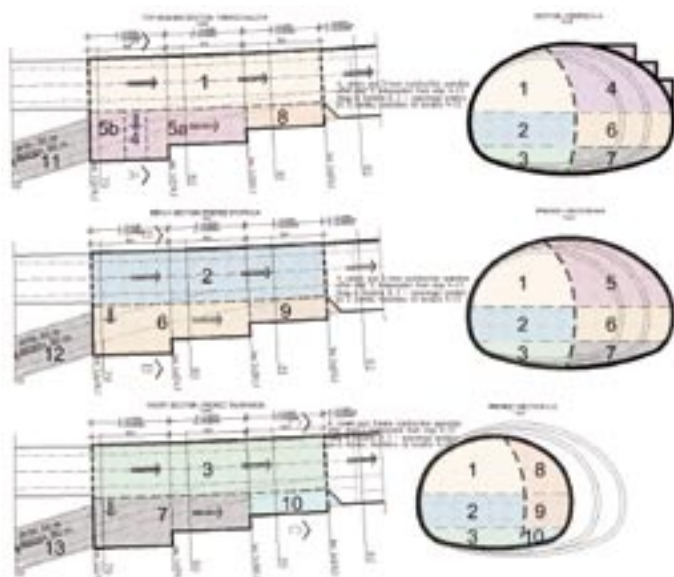

Slika 6-5: Faze izkopa kaverne

Začetek izkopa profila kaverne se predvidi kot podaljšek iz dvopasovne cevi. V splošnem je izkopni profil kaverne razdeljen na dva ločena dela, levi (A) in desni (B) del, vsak pa je razdeljen na osnovne dele kaloto, stopnico in talni obok. Del A se izvede v celoti v korakih 1 – 3 s kaloto, stopnico in talnim obokom vključno z zapiranjem le tega. Zatem se zasuje del A do spodnje kote kalote, s čimer se omogoči neovirano nadaljevanje izkopa za tripasovno cev v nadaljevanju. Izkopni koraki 4 – 11 se tako izvajajo neodvisno od izkopa glavne cevi. Višine kalote, stopnice in oboka so v vsakem odseku kaverne na istem nivoju, kar olajša gradnjo.

Po zaključku izkopa kaverne se nadaljuje z izkopom priključne cevi iz smeri kaverne v skupni dolžini 50 m, kjer se združi z izkopom iz severnega

portala. Preboj priključne cevi se izvede na lokaciji, kjer je bližja stran priključne cevi oddaljena najmanj 1 – 1,5 premera od glavne cevi. Prvih 12 m priključne cevi je izvesti v modificirani C3 kategoriji s podaljšanimi sidri neodvisno od dejanske geomehansko-geološke situacije. Dodatni podporni ukrepi med stacionažo km 1.5 + 44.30 m in 1.5 + 56.30 m tvorijo z dodatnim podporjem v dvopasovni cevi, analogen sistem podpiranja kot v kaverni, s čimer se razbremeni osrednji steber med priključno in dvopasovno cevjo.

Za vsak odsek kaverne je zasnovano podpiranje za dve hribinski kategoriji. Hribinska kategorija I za relativno ugodne pogoje in močnejša kategorija II za stiskajočo hribino s povečanim napetostnim stanjem. Bistvena razlika med obema kategorijama je, da je v kategoriji II predvidena večja gostota in dolžina sider, hkrati je predvideno varovanje talnega oboka s sidri. Količina čelnih sider se prav tako poveča v kategoriji II, hkrati pa se predvidi uporaba deformacijskih reg v primarni oblogi. Zaradi možnosti

pojava povečanega napetostnega stanja hribine je bil cilj zasnovati kar se da podajno podporje, kjer se večji delež obremenitev prenese z veliko količino vgrajenih sider in ne z odpornostjo same betonske obloge. V podporo konceptu podajnega podporja kaverne je v predlagani zasnovi izključena uporaba ukrepov, ki povečujejo togost predorske lupine kot sočasni talni obok in izvedba pete kalote. Z obratnim namenom se predvidi vgradnja deformacijskih reg. Debelina obloge brizganega cementnega betona največjega profila kaverne je 50 cm, od tega se prvih 35 cm z dvema plastema mrež izvede



Slika 6-6: Faza izkopa kaverne s prikazano lokacijo in velikostjo raziskovalnega rova

med izkopom dela A, ostalih 15 cm z dodatno plastjo mreže pa se nanese skupaj v enem koraku z zadnjo plastjo brizganega betona dela B. Samo talni obok se, zaradi enostavnosti izvajanja, izvede naenkrat v skupni debelini 50 cm.

#### 7. Ureditev portala Šentvid

##### 7.1 Projektna naloga

Območje severnih portalov sodi v mestni urbani prostor z zgoščeno prometno infrastrukturo, kjer se na razmeroma omejenem in ozkem prostoru pojavi večnivojsko vozlišče s številnimi objekti, ki so vezani na funkcionalno delovanje predora, kot tudi povezave za normalno delovanje Celovške ceste z vsemi pripadajočimi elementi in tehnologijo gradnje. Arhitekturno oblikovanje mora zagotoviti kvalitetno prostorsko obravnavanje območja katerega cilj je enoten in usklajen izgled med obravnavanimi segmenti. Obravnavani prostor je zaradi svoje lege izjemno občutljiv. Glavna tema naloge je preobrazba ali metamorfoza podhoda v kvalitetni urbani prostor. Pri oblikovanju je odločilno različno obravnavanje pešpoti oziroma potencialnih kolesarskih poti od prometnega cestišča, generirajo se tri ravni prostorskega dožemanja in sicer iz gledišča voznika, iz gledišča pešca in iz perspektive kolesarja. Arhitekturno oblikovanje severnega portala zajema vse vidne objekte, ki določajo podobo obravnavanega območja.

Slika 7-1: Shema ureditve portala Šentvid

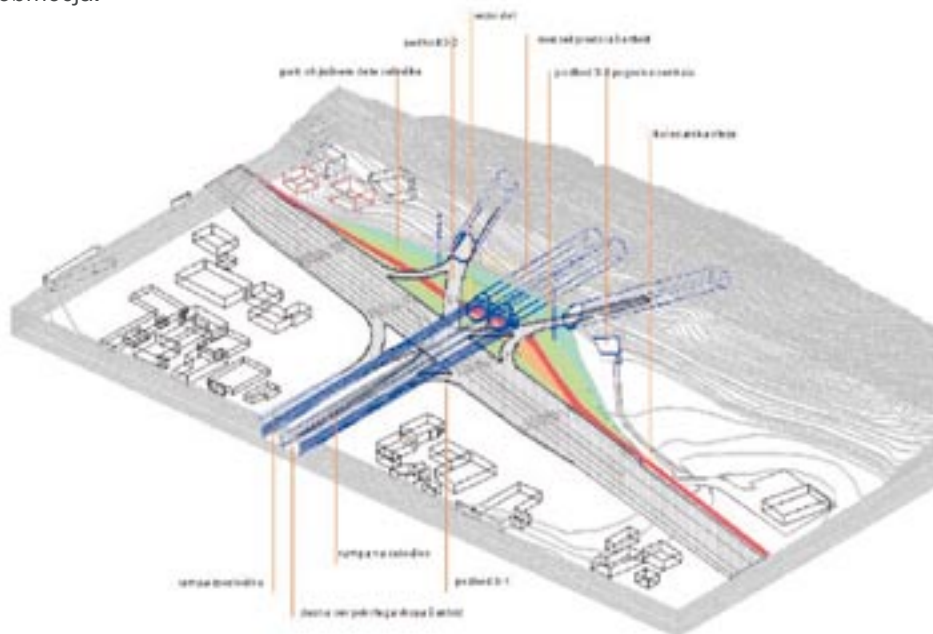

##### 7.2 Opis predlagane rešitve

Predlagane rešitve se nanašajo na dejanske tehnične parametre, ki izhajajo iz tehnologije gradnje in omejenega prostora, ki je na voljo. Kolesarska steza je speljana pod priključnimi rampami in nad vkopanim delom predora. Steza je speljana tako, da je zagotovljena največja dolžina katera omogoča primeren naklon, ki je primeren za kolesarsko stezo. Glavno vodilo pri oblikovanju prostora pod podhodi je zagotoviti čim bolj pregleden enotno oblikovan prostor s čim širšim prečnim profilom, ki bo omogočal pešcem in kolesarjem varen prehod pod priključnimi rampami predora. Širina prečnega profila in odprtost prostora pod rampami zagotavlja preglednost in dobro osvetljenost iz gledišča kolesarja in pešca. Mostovi priključnih ramp morajo delovati čim lažje, kar dosežemo z izborom konstrukcijskega sistema jeklenih stebrov, ki podpirajo betonsko cestišče, tako dosežemo optimalne razpone konstrukcij in za-

gotovimo željeno širino prečnega profila. Most je opremljen z varovalnimi ograjami z odbojniki, ki bodo izvedene s polnili iz pleksi stekla različnih barvnih odtenkov.

Površine ob kolesarski stezi so zasnovani kot delno zatravljene površine, delno pa kot tlakovane površine, katere se lahko uporabljajo kot prostor z urbanim programom. Prostor ni zasnovan kot klasični park, ker zaradi svojih robov, ki ga določajo bolj sodi v urbani prostor na stiku z ozelenjenim pobočjem. Obravnavano območje ni namenjeno zadrževanju, temveč prehodnosti skozi artikuliran prostor, ki bo za mimo-idočega predstavljal prostorsko kvaliteto. Posamezni elementi predlagane rešitve so izbrani na način, ki bo predstavljal čim manjše stroške vzdrževanja. V obravnavanem prostoru je posebno pozornost potrebno posvetiti primerni osvetljenosti prostora. V ta namen so predvideni trije sistemi osvetljevanja in sicer osvetlitev cestišča, osvetlitev kolesarske steze in osvetlitev prostora v območju podhodov.

Slika 7-2: Shema ureditve portala Šentvid

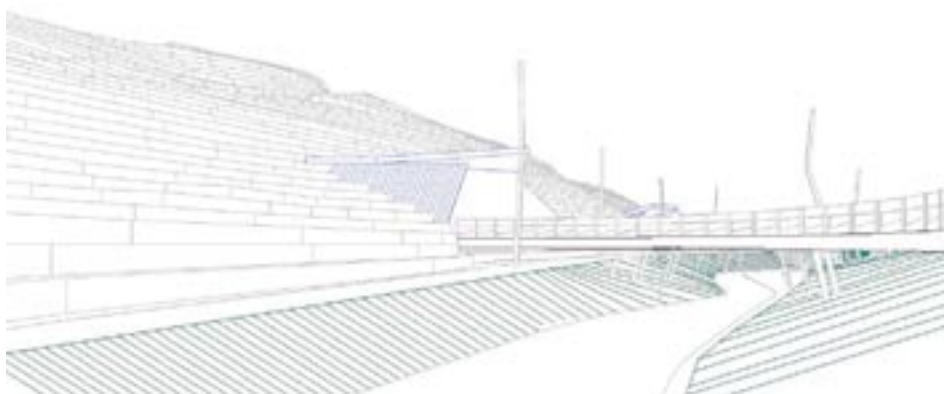

#### Reference:

1. PNZ (Projekt nizke zgradbe, Vojkova 54, 1000 Ljubljana) "A2 – Karavanke–Obrežje; sector: Šentvid–Koseze" št. C-255; Julij, 2003
2. ZAG (Zavod za gradbeništvo, Dimičeva 12, 1001 Ljubljana) in iC consulenti (Zollhausweg 1, A-5101 Salzburg/Bergheim) "Pregled geoloških in geomehanskih podatkov o trasi predora" št. 1338/03 –11 – DP7H; Julij 2004
3. GZL (Geološki zavod Slovenije, Dimičeva 14, 1001 Ljubljana) "Hidrogeološko poročilo za predor Šentvid" št. J-II-30d/b4-6/22-e; Julij 2000
4. GZL (Geološki zavod Slovenije, Dimičeva 14, 1001 Ljubljana) "Inženirsko geološka prognoza razmer na trasi predora Šentvid" št. 295-1/91; leto 1991
5. ZAG (Zavod za gradbeništvo, Dimičeva 12, 1001 Ljubljana) "Poročilo za dopolnilne geološko-geomehanske raziskave za PGD, PZI predora Šentvid" št. P0013.0112; leto 2000
6. GEOT (Dimičeva 12, 1001 Ljubljana) "Poročilo o geološko-geotehnični obdelavi prečnih profilov galerije Šentvid (P47-P54) na trasi AC Šentvid–Koseze"; leto 2003
7. PNZ / GEOT "Geološko-geomehansko poročilo za traso AC Šentvid–Koseze, odsek km 2,1 + 40,00 do 2,4 + 00,00"; leto 2003
8. ZAG (Zavod za gradbeništvo, Dimičeva 12, 1001 Ljubljana) "Geološko-geomehansko poročilo za galerijo Šentvid"; leto 2003
9. ZAG (Zavod za gradbeništvo, Dimičeva 12, 1001 Ljubljana) "Delno poročilo o geološko-geomehanskih pogojih gradnje predora Šentvid"; leto 2003
10. ZAG (Zavod za gradbeništvo, Dimičeva 12, 1001 Ljubljana) "Poročilo o geološko-geomehanskih razmerah v območju obvoza Celovške ceste in portala predora Šentvid"; leto 2003
11. ELEA iC (Dunajska 21, 1000 Ljubljana) "Začetna dela; Pokriti vkop Šentvid, PGD" št. 3074; Julij, 2003
12. ELEA iC (Dunajska 21, 1000 Ljubljana) "Začetna dela; Oporna konstrukcija, PGD" št. 3074; Julij, 2003
13. ELEA iC (Dunajska 21, 1000 Ljubljana) "AC Šentvid–Koseze; Predor Šentvid - Severni portal, PGD" št. 3329; Marec, 2004
14. ELEA iC (Dunajska 21, 1000 Ljubljana) "AC Šentvid–Koseze; Predor Šentvid – Raziskovalni rov, PGD" št. 3327; Januar, 2004

## Tehnično tehnološke posebnosti gradnje predora Kastelec

Prof.dr. Jakob Likar, univ.dipl.inž.  
Univerza v Ljubljani  
Naravoslovnotehniška fakulteta  
Aškerčeva 12  
1000 Ljubljana

Doc.dr. Vojkan Jovičič, univ.dipl.inž.  
Simona Markič, univ.dipl.inž.  
Melanija Huis, univ.dipl.inž.  
IRGO CONSULTING, d.o.o.  
Slovenčeva 93, 1000 Ljubljana

### Izvleček

Območje gradnje predora Kastelec je del kraškega hribovja na odseku avtoceste med Klancem in Serminom. Kraški pojavi in relativno trdno kamninsko ogrodje iz apnenca sta osnovni značilnosti, ki prevladujeta na tem delu bodoče avtoceste. Čeprav so trdnosti intaktnih vzorcev kamnin, ki gradijo to območje dokaj visoke in znašajo do okrog 70 MPa, je prisotna tektonska poškodovanost ter kraške značilnosti s kavernami in zakraselimi območji. Ti pojavi so v veliki meri vplivali na prilagoditev gradnje dejanskim razmeram. Preverjanje velikosti podzemnih praznih prostorov in stanja njihovega ostenja kakor tudi naravnih znamenitosti (kapniki, obstoj živali, ipd.) je zahtevalo posebne ukrepe med gradnjo. Gradbene faze, ki so bile uporabljene, so bile izvajane sukcesivno v kaloti in stopnici katerima je sledila vgradnja temeljev in odvodnjevalnega sistema v primerni oddaljenosti. Relativno visoke hitrosti napredovanja izkopa in primarnega podpiranja so bile pogojene s kakovostno izvedbo izkopnih faz tako da ni prihajalo do povečanih profilov izkopa po nepotrebnem. Vgradnja geotekstila in hidroizolacije ter notranje obloge iz cementnega betona MB30 je potekala v kampadah po 12 m. Sprotna geološko geotehnična spremljava je dajala dovolj dobre informacije o nastopajočih hribinskih razmerah, tako da ni bilo večjih težav z napredovanjem. Uspešno dokončana gradnja je bila plod strokovnega in korektnega sodelovanja med Izvajalcem, Inženirjem in Projektantom.

### Abstract

#### Technical and technological particularities Kastelec tunnel construction

The area of construction of the tunnel Kastelec belongs to karst morphology located at the motorway section between Klanec and Sermin. The karst phenomena imbedded in a relatively sound rock matrix is the main characteristic of geological conditions important for the construction of the tunnel. The intact rock strengths were recorded up to 70 MPa, but the interplay of tectonic and karst features in the rock dictated the demanding conditions for the works and careful approach in design. The regular investigation was carried out on the density of the karst features such as big underground caverns, or presence of abysses but also on the local features of the simple karst weathering. The aim was to preserve as much as possible of the precious natural environment that included the karst decorated caverns with living underground fauna. This demanded a particular approach in design and construction of this tunnel. The construction phases included successive excavation of the tunnel profile, which was regularly divided into the top heading and the bench. This was followed by the excavation and construction of foundation and the drainage system at a particular distance. Relatively high advances of excavation and installation of the pri-

mary lining were conditioned by careful drill and blast techniques so that there were no significant over excavation of the profile.

## 1. Uvod

Bodoča avtocesta med Kozino in Koprom bo sestavni del prometne povezave med vzhodom in zahodom Republike Slovenije in bo istočasno vključena v prometno omrežje med vzhodno in zahodno Evropo, oziroma med vzhodno in južno Evropo. Del te povezave je odsek Klanec – razcep Srmin od km 11,5 do km 27,4. Dolžina tega odseka vključno s predorom Kastelec znaša 15,9 km.

Trasa tega odseka poteka od km 11,5 do km 19,0 po varianti D III/2, od km 19,0 do 26,4 pa po varianti D I/2T in sicer južno od obstoječe ceste M10 do izven nivojskega križanja. Trasa nato prečka dolino Smelavc z viaduktom dolžine 200 m, hrib Brgodec pa v vkopu in se nadaljuje v predor Kastelec. Naprej poteka trasa mimo vasi Kastelec, kjer bo izdelan priključek Kastelec in preko viadukta Črni kal nad Osapsko Dolino. V nadaljevanju poteka trasa po pobočjih Tinjanskega hriba in čez Globoki potok ter se nadaljuje v dvocevni dvopasovni predor Dekani proti Ankaranskemu križišču. Situacija predora je podana na sliki 1.

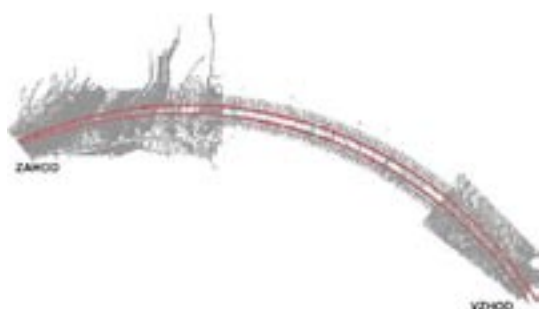

Slika 1: Situacija predora Kastelec

Tehnični elementi predora Kastelec so naslednji

Leva cev (smer Koper–Ljubljana)	Desna cev (smer Ljubljana–Koper)
<ul style="list-style-type: none"> <li>• cev poteka od km 13,2+75.00 do km 15,5+95.00,</li> <li>• maksimalna nadmorska višina: okoli 380 m na vzhodnem portalu,</li> <li>• vzdolžni sklon: -2,546%,</li> <li>• prečni sklon vozišča: 2,50% (desna krivina),</li> <li>• minimalni horizontalni radij: 1794,40 m</li> </ul>	<ul style="list-style-type: none"> <li>• cev poteka od km 13,3+05.00 do km 15,5+35.00,</li> <li>• maksimalna nadmorska višina: okoli 380 m na vzhodnem portalu,</li> <li>• vzdolžni sklon: -2,492%,</li> <li>• prečni sklon vozišča: 2,50% (leva krivina),</li> <li>• minimalni horizontalni radij: 1805,60 m</li> </ul>

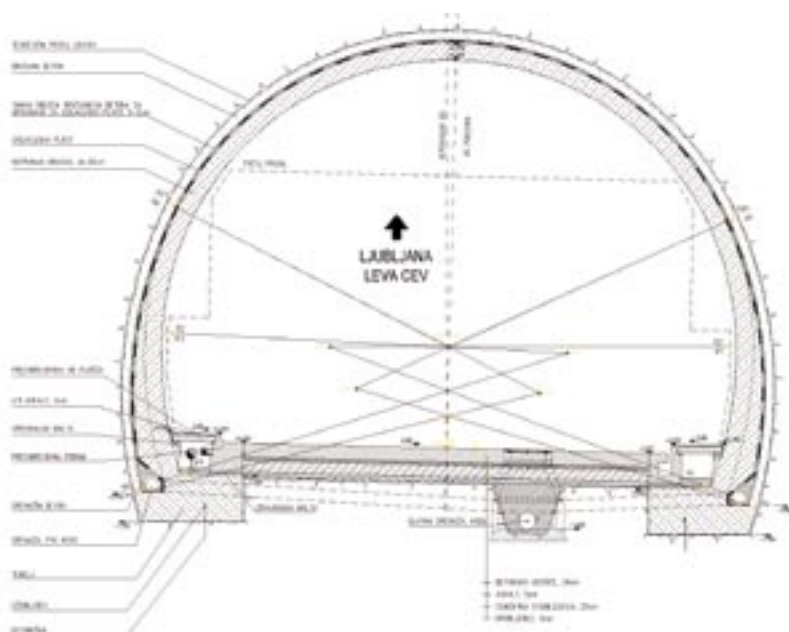

Dejanska dolžina leve cevi znaša cca 2278 m merjeno po osi predora, dolžina desne predorske cevi pa 2230 m. Velikost prečnega prereza predora je določena s svetlim profilom predora. Širina vozišča znaša 7,70 m, z dvema voznima pasovoma širine 3,50 m in obojestranskima robnima trakovoma širine 0,35 m. Vertikalna višina voznega svetlega profila znaša 4,70 m.

Slika 2: Splošni prečni profil predorske cevi brez talnega oboka.

#### 2. Značilnosti geološke zgradbe območja

Na območju obeh predorskih cevi so ugotovljeni štirje karakteristični odseki, ki se razlikujejo med seboj v geološkem pomenu. Ocene RMR (ROCK MASS RATING) za vsako hribinsko kategorijo in posebnostmi na posameznih presekih, so se pokazale kot primerne in strokovno utemeljene za določitev realnih izkopnih hribinskih kategorij.

Na začetku izkopa obeh cevi, ki je potekal od zahoda proti vzhodu je bilo ugotovljeno izklinjanje t.i. prve flišne luske v desnih bokih obeh predorskih cevi. Ta odsek je sicer kratek vendar je dovolj markanten, da je oddvojen in je obravnavan kot del litološke spremembe. Nadaljevanje izkopa obeh cevi zaznamujejo občasna pojavljanja kavernoznosti, bodisi v obliki odprtih – cevastih razpok ali manjših kraških jam. Do prehoda v drugo flišno lusko je bil ugotovljen prevladujoč in večinoma neplastovit temno siv alveolinsko-numulitni apnenec. Mestoma se je pojavljal tudi svetlo siv različek, vendar kontakti obeh niso kazali sistema plastovitosti, ampak bolj na premike posameznih blokov v geološki preteklosti. Glavni kontakt z t.i. drugo flišno lusko sovpada z lokacijo zadnjega prečnika, ki pa je še v celoti izkopan v apnencu. Nadaljevanje izkopa od prečnika naprej je potekalo v flišni kamnini, ki jo predstavlja zelenkasto siv meljasti apneni lapor z enovito usmerjenim klivažem proti severovzhodu. Flišna luska je bila v levi predorski cevi ugotovljena v dolžini 160 m, v desni cevi pa v dolžini 128 m. Zadnji kontakt z apnencem je bil tektonske narave, zato je temu primerno bolj gosto nadrobno skrilav in pretrt. To je bilo opaziti v meljevecu, kakor tudi v apnencu. Zadnji karakteristični del tako poteka od zadnjega kontakta z flišno lusko pa vse do konca odseka t.j. do konca zadnje odstavne niše v predoru. V tem delu smo opazovali neplastovit, pretežno temnosiv alveolinsko-numulitni apnenec. V nadaljevanju sta predorski cevi prešli v območje intenzivnejšega zakrasevanja, ki se je kazalo s pogostimi sistemi cevastih kavern.

#### 2.1 Hidrogeološke razmere v predoru

Kot se spodobi v kraškem območju so vtoki vode v predorski cevi bili neposredno vezani na deževna obdobja. Prav tako smo opazovali le 1-2 dnevni zamik po končanem padavinskem obdobju, ko intenzivnost vtokov v predor naglo upadala. Kasneje so bila opazna le še posamezna kapljanja ob razpokah, oziroma kontaktih druge flišne luske. Največji vtoki so bili v območjih cevastih kavern, kjer so ocenjeni pretoki znašali tudi do 10 l/s. V območju 2. flišne luske ni bilo opaznih vtokov vode v predorske cevi, izjemoma le v območju kontaktov z apnencem.

#### 3. Izkopna dela in primarno podpiranje

Gradnja predora Kastelec je bila izvajana ob upoštevanju principov »Nove avstrijske metode gradnje predorov (NATM)«, ki je zasnovana tako, da hribino okrog območja izkopa obravnavamo kot breme ter tudi kot nosilni obroč, ki breme prevzema. Zaradi zmanjšanja večjih deformacij kamnin v okolici predorske cevi je bil izvajan izkop predora v deljenem profilu na kaloto in stopnico (talni obok). Vsaki fazi izkopa je sledila takojšnja vgradnja primarne podgradnje, pri čemer so osnovne podporne elemente predstavljali brizgani cementni beton, armaturne mreže, jekleni loki in hribinska sidra. Z izvajanjem geotehničnih meritev in opazovanj pomikov ostenja primarne obloge je bilo možno v času gradnje projektno predvidene podporne elemente prilagoditi dejanskemu stanju v hribini.

### 3.1 Tehnologija izkopa in vgradnje podpornih elementov

Tehnologija in način, vrsta in količina vgrajenih podpornih ukrepov v posameznih hribinskih kategorijah je bila izvedena skladno z »Rudarskim projektom za izvajanje del – Izkop predora Kastelec«, št. proj. ic 559/01 december 2001, na podlagi katerega je izvajalec del SCT, d.d. dne 1.3.2002 pridobil od Ministrstva za okolje, prostor in energijo, Uprava RS za rudarstvo, dovoljenje za izvajanje del, št. dovoljenja 354-15-2/2002.

Izvajalec del je uporabil dve osnovni tehnologiji izkopa predorskih cevi, in sicer:

- izkop predora z miniranjem v hribinskih kategorijah A2, B1 in B2, kjer je trasa predora sekala kompaktni dolomitizirani apnenec;
- izkop predora s predorskim bagrom v hribinski kategoriji PC1 oziroma flišnih plasteh.

### 3.2 Hribinska kategorija A2

Tehnologija izkopa in osnovne podgradnje je bila uporabljena v hribini, ki je podvržena manjšim porušitvam, z lepo izraženimi elastičnimi lastnostmi. Deformacije, ki so posledice izkopa, so bile majhne velikostne stopnje in so se s časom hitro umirile.

Manjše porušitve so obstajale v stropnih in zgornjih predelih izkopnega profila, kot posledica neugodne lege slojev in lastne teže manjših blokov kamnine. V splošnem je bil v tej hribinski kategoriji z uporabo vrtnja in razstreljevanja izveden izkop celega profila naenkrat, v nekaterih primerih pa je bilo pri čelo izkopa razdeljeno na kaloto in stopnico. Dolžina izkopnega koraka je znašala od 2,5 do 3,5 m v kalotnem delu in od 4 do 5 m v območju stopnice predora.

Pri miniranju je bil uporabljen klinasti zalom. Konturne vrtine se bile zavrtane v razdalji 40-50 cm in polnjene z zmanjšano polnitvijo oz. količino razstreliva.

Na novo izkopani del predorske cevi je bil takoj po končanem odvozu zdrobljene kamnine obrizgan z varovalno plastjo brizganega betona, v nekaterih primerih pa je bil glede na kvaliteto hribine varovalni obrizg izveden pred odvozom razstreljenega materiala. Za vgradnjo brizganega betona je bil uporabljen mokri postopek nanašanja brizganega betona.

Sidra so bila vgrajevana po potrebi glede na sproti ugotovljene geotehnične razmere, najkasneje dva koraka za izkopnim čelom predora, oziroma takoj po izkopu, če je bilo to potrebno. Smer vgradnje sidrnega sistema je bila izbrana glede na lego in razsežnost diskontinuitet.

Podporni elementi so bili vgrajeni sistematično pred vsakim naslednjim korakom izkopa v naslednji sestavi:

- armaturna mreža Q 189 (vgrajena pri vgradnji brizganega betona debeline 10 cm);
- brizgani beton d = 5-10 cm;
- SN sidra dolžine 3,0 m – vgrajena so bila dva koraka za izkopnim čelom.

Izvedena geometrija in tehnologija izkopa sta podani na sliki 3.

## 7. mednarodno posvetovanje o gradnji predorov in podzemnih prostorov

### TEMA 2 | NAČRTOVANJE KONSTRUKCIJ IN VZDRŽEVANJE PODZEMNIH PROSTOROV

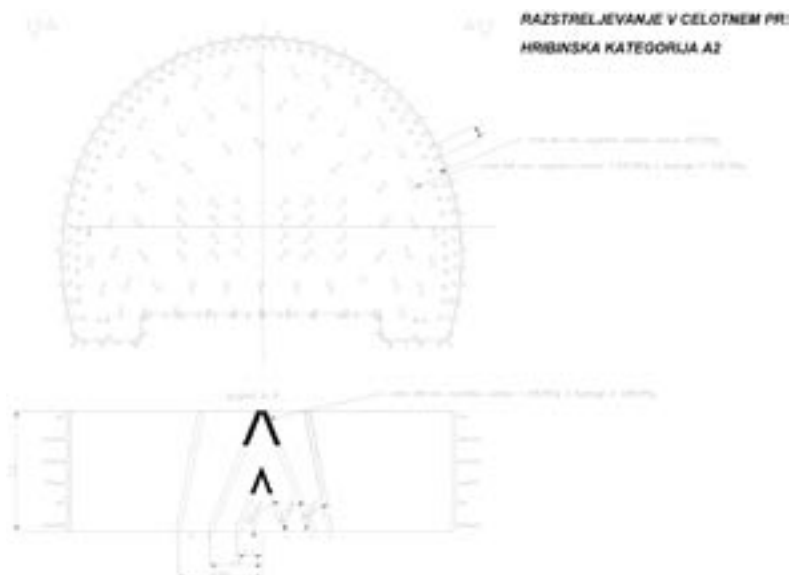

Slika 3: Izkop v hribinski kategoriji A2.

je bil z uporabo vrtnja in razstreljevanja izdelan v dveh fazah, tako da je bil razdeljen na kaloto in stopnico. Korak izkopa v območju kalote je znašal od 1.8 do 2.5 m in od 3.6 do 4 m v območju stopnice.

Podporni elementi so bili vgrajevani sistematično pred vsakim naslednjim korakom izkopa in sicer:

- armaturna mreža Q 189;
- jekleni segment TH 21 - vgrajena po potrebi v kaloti;
- brizgani beton  $d = 10\text{--}15\text{ cm}$ ;
- SN sidra dolžine 4.0 m – vgrajena en korak za izkopnim čelom.

Jeklene sulice so bile vgrajene v stropni del kalote po potrebi glede na ugotovljene geotehnične pogoje. Način razstreljevanja v hribinski kategoriji B1 je prikazan na sliki 4.

#### VRTALNA SCHEMA IN POLNITEV VRTIN



Slika 4: Vrtalno minerska shema za napredovanje izkopa v hribinski kategoriji B1.

V posameznih odsekih je bil v hribinski kategoriji A2 uporabljen mikroarmirani brizgani cementni beton debeline 8 cm. Ta je nadomestil brizgani cementni beton debeline 5 - 10 cm in armaturno mrežo Q 189. v danem primeru je bil napredek večji, podpiranje učinkovitejše in tehnološko povsem opravičljivo.

### 3.3 Hribinska kategorija B1

Po izkopu so se v hribini, ki je značilna za to hribinsko kategorijo, razvile v kratkem času deformacije majhnega velikostnega reda, katerih hitrost se je hitro zmanjšala na nič, kar pomeni da je bila kamnina dobro samonosilna. Izkopni profil

### 3.4 Hribinska kategorija B2

Izkop kalote v koraku 1.5m se je izvajal delno z izkopnim bagrom in delno z razstreljevanjem kot načinom rahljanja kamnine. Sicer je bil izkop izveden z bagrom ob uporabi hidravličnega odkopnega kladiva za izkop trdih delov kamnine.

Proste ploskve, ki so nastale pri vsakem izkopu, so bile takoj po odvozu zdrobljene hribine s čela kalote ali pa tudi prej, zaščitene z varovalnim obrizgom iz brizganega betona MB25.

Podporni elementi so bili vgrajevani sistematično pred vsakim naslednjim korakom izkopa in sicer:

- armaturna mreža Q 189 (vgrajena na že vgrajen jekleni segment in pritrjena z vzdolžno armaturo RA fi 28);
- jekleni segment TH 21 – vgrajen sistematično na vsakem izkopnem koraku;
- brizgani cementni beton  $d = 20\text{ cm}$ ;



- SN ali IBO sidra dolžine 4.0 in 6.0 m – vgrajena so en korak za izkopnim čelom;
- jeklene sulice za zaščito stropa pri izkopu kalote pred naslednjim korakom izkopa. Izkop stopnice se je izvajal delno z izkopnim bagrom in delno z miniranjem.

Pri izvedbi temelja s talnim obokom so dela potekala v naslednjem vrstnem redu:

- izkop za temelj;
- montaža opaža in betoniranje temelja v predpisanih kampadah;
- izkop za talni del;
- montaža opaža talnega dela in betoniranje v enakih dolžinah, ko so bile izvedene kampade temelja.

Glede na geotehnične pogoje je bil talni del zaključen v oddaljenosti max. 200 m od čela kalote. Izvedeni podporni ukrepi za hribinsko kategorijo B2 so prikazani na sliki 5.

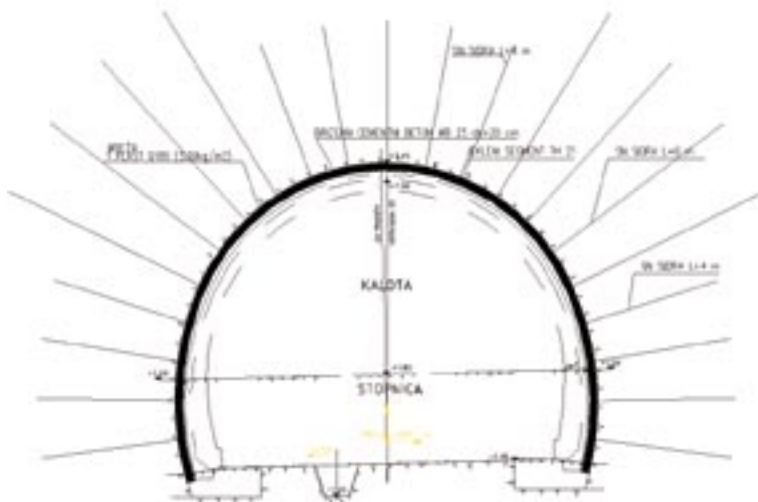

Slika 5: Podporni krepji za hribinsko kategorijo B2.



Slika 6: Podporni ukrepi za hribinsko kategorijo PC1.

### 3.5 Hribinska kategorija PC1

Takojšnja vgradnja podpornih elementov je tudi v tej hribinski kategoriji zagotavljala majhne deformacije, ki so se hitro zaustavile. Zakasnela vgradnja podpornih elementov, ali pa premajhna količina podpornih elementov bi povzročila deformacije, ki bi sprožile pomike in povzročile nestabilnosti brežin na portalih. Izkopni profil je bil razdeljen na: kaloto in stopnico. Izkop kalote je bil izveden z bagrom. Pred izkopom vsakega naslednjega koraka so bili vgrajeni naslednji podporni elementi:

- brizgani cementni beton MB25,  $d_s = 20 \text{ cm}$ ;
- 2 plasti mreže Q 189;
- jekleni segment TH 21;
- sulice  $1 \frac{1}{2}''$ ,  $s=4 \text{ mm}$ ,  $l=3\text{m}$ .

Največ en korak za izkopnim čelom so bila vgrajena SN sidra, dolžine 4 m.

Izkop stopnice je sledil izkopu kalote na razdalji 2.6 m, ki še omogoča nemoteno delo na kaloti. Obseg podpornih elementov je ostal glede na kaloto enak, izkopni korak pa je enak dvojnemu koraku v kaloti. Izvedeni podporni ukrepi za hribinsko kategorijo PC1 so prikazani na sliki 6.

### 4. Podporni ukrepi v območju kraških jam in lijakov



Slika 7: Kraški pojavi v predoru Ka-stelec.

Območje predora pripada v pretežni meri Petrinjskemu krasu s številnimi vrtačami in kraškimi jamami. Pri prehodu izkopnih del skozi to območje so se pojavljale kraške posebnosti, katerih del je prikazan na sliki 7.

Izvedeno je bilo predvrtavanje, s katerim so bile ugotovljene predvsem praznine, katerim je bila prilagojena tehnologija izkopa in vgradnja podpornih elementov.

Zaporedje izvajanja del pri velikih kraških jamah je potekalo v naslednjem vrstnem redu:

- vgradnja podpornih varnostnih ukrepov (mikroarmirani brizgani beton in vgradnja hribinskih sider);
- izgradnja temeljne plošče: izkop za temeljno ploščo in vgradnja betona MB30;
- vgradnja drenažnega sistema za odvodnjevanje jame (pri ugotovljenih kraških kavernah in lijakih, ki predstavljajo stalen vir dotokov hribinske vode, kot posledice padavin, so bile pred vgradnjo podpornih elementov po zunanjem obodu predorske cevi vgrajene drenažne cevi za odvodnjevanje hribinske vode iz kraških formacij. Drenažna cev poteka od temena predorske cevi v spodnji del predora v temeljno ploščo, od koder se voda spelje v bočno drenažo. Velikost drenažnih cevi za odvodnjevanje stalnih dotokov hribinske vode je bila določena na osnovi izmerjenih dotokov vode iz kraških formacij;
- vgradnja dvostranskega opaža za betonsko zalitje – prva faza;
- zalitje z betonom MB30 – prva faza;
- vgradnja jeklenih segmentov in brizganega betona MB25;
- zalitje z betonom MB30 – druga faza.

Tehnologija izkopa in vgradnje podpornih elementov v območju kraških jam in lijakov je prikazana na sliki 8.

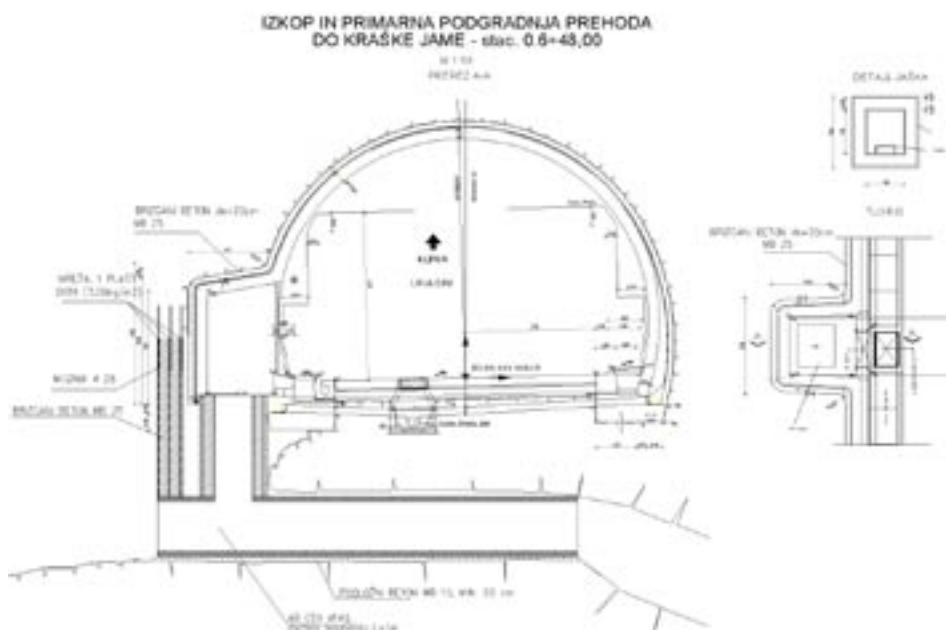

Slika 8: Podpiranje v predelih kraških kavern.

### 5. Vgradnja temeljev, odvodnjevalnega sistema, hidroizolacije in notranje obloge

Betonerska dela v predoru so bila izvajana zaporedoma brez večjih zastojev, saj so bile deformacije, ki so se razvile v času izkopa in vgradnje primarne obloge hitro časovno umirjene. Vgradnja temeljev in talne plošče je potekala v kampadah po 6 m oz 12 m. Posebna pozornost je bila posvečena gradnji odvodnjevalnega sistema za hribinsko vodo, ki je ločeno speljana iz predora od cestiščne vode, katera je onesnažena in zahteva poseben tretma, preden je spuščena v naravno okolje. Dimenzije temeljev in drugih konstrukcijskih elementov so prikazane na sliki 2, kjer je prikazan karakteristični prečni profil predora. Na sliki 9 je prikazana priprava na vgradnjo notranje obloge.



Slika 9: Opaženje odstavne niše in prečnika



Slika 10: Vzhodni portal predora Kastelec.

### 6. Tehnične rešitve portalov z upoštevanjem kraških značilnosti območja

Oblikovanje portalnih območij v kraškem terenu je pogojeno z naravnimi danostmi, ki so značilne za te predele poteka avtoceste. Po eni strani smo imeli opravka s kamnitimi tlemi delno poraščenimi z rastlinjem in delno skoraj golimi močno hrupnimi površinami. Prav tako so bili značilni hitri preskoki med naravno oblikovanimi ploskvami, kar je značilno predvsem za manj poraščene površine. Geotehnični vidik takšnih območij, kjer so načrtovani portali, je povezan z relativno trdnimi kamninami, kjer se pogosto pojavljajo potencialne porušitve v obliki klinov, blokov ipd., ki pa so z manjšimi količinami podpornih elementov obvladljivi in v večini primerov ne predstavljajo večjih problemov za doseganje trajne stabilnosti.

Navedene osnove povezane z naravnimi danostmi so narekovale oblikovne rešitve za katere je značilno naslednje:

- oblika portala je primerna glede na naravne oblike površja;
- dolžina pokritih vkopov je majhna, ker so hribinske razmere za prehod v rudarski del predora ugodne in ne zahtevajo vgradnje večje količine podpornih elementov;
- vremenske razmere v različnih letnih časih so takšne, da temperatura ne pade pogosto pod zmrzišče;
- trajno stabilnost portalov je moč zagotoviti z gradnjo relativno tankih AB konstrukcij, ki morajo ustrezati predpisanim zahtevam.

Na sliki 10 je prikazana rešitev portala na vzhodnem delu predora, kjer so upoštevana zgoraj navedena priporočila.

#### 7. Povzetek

- Gradnja predora v kraškem območju, ki ga gradijo relativno trdne kamnine, je zahtevala izvedbo specifičnih ukrepov za premostitev kraških jam in kavern ter drugih posebnosti, ki so prisotne v kamninski zgradbi.
- Hitrost napredovanja izkopa z vrtanjem in razstreljevanjem je bila prilagojena pogojem, ki jih je narekovala kraška kamninska zgradba tako, da so bili doseženi največji napredki do 10m/dan na enem gradbišču.
- Vse prepreke, ki so se pojavile med gradnjo na odsekih, kjer sta predorski cevi prečkali kraške jame in kaverne so bile hitro odpravljene, saj je bilo sodelovanje partnerjev pri gradnji konstruktivno.
- Vgradnja temeljev, notranje obloge in drugih sestavnih delov predorskih cevi je potekala usklajeno s primernim zamikom ob zagotavljanju predpisane kakovosti.
- Izvedba portalov je bila pogojena z naravnimi posebnostmi krasa in končni izgled ustrezen.

#### 8. Zahvala

ISKRENO SE ZAHVALJUJEMO UPRAVI DARS, D.D. IN DDC, D.O.O. ZA IZKAZANO ZAHVALNOST PRI AKTIVNEM SODELOVANJU PRI GRADNJI PREDORA.

#### LITERATURA:

J. Likar, et. all. PZI predora Kastelec, IRGO CONSULTING, d.o.o., Ljubljana, 2001–2004

## Excavation and Construction of Dekani Tunnel Izkop in gradnja predora Dekani

Doc.dr. Vojkan Jovičič, univ.dipl.inž.grad.  
IRGO Inštitut za rudarstvo, geotehnologijo  
in okolje  
Slovenčeva 93, 1000 Ljubljana  
Tel. +386 1 560 36 21  
vojkan.jovicic@i-rgo.si

Prof.dr. Jakob Likar, univ.dipl.inž.rud.  
Univerza v Ljubljani  
Naravoslovnotehniška fakulteta  
Aškerčeva 12, 1000 Ljubljana  
Tel. +386 1 470 46 10  
jakob.likar@uni-lj.si

### Summary

The twin Dekani tunnel is located on the Primorska motorway at the Section Klanec – Sermin. The tunnel runs through the geological sequence of flysch along the full 2150 m length. The flysch is best described as a turbidite made of intermittent layers of sandstone and marl. The excavation and the primary support of the tunnel were successfully carried out using the principles of the NATM method. The technological sequence of the works was improved by the use of microfibre sprayed concrete lining, which lowered the costs of excavation and brought about the time and material savings so that the excavation of the tunnel finished 4 months before the schedule. The structural works that took place during the construction of the tunnel were also significant. Two enlarged cross-tunnel connections were built between the two tubes. This allows for redirection of the whole traffic in the tunnel in the case of fire, thus contributing to the overall safety measures. The axis of the left tube of the tunnel was positioned in parts to be very close to the surface, reaching up to 6 m at some places. At the location of the Zamatavinec depot the left tube of the tunnel cropped up and the 60 m long cut and cover structure was built. The difficult morphology at the West portal entrance dictated the elaborate cut and cover section at this location too. The complex interaction between the portal structures, retaining walls and embankments is described in the paper.

### Povzetek

Dvojni predor Dekani se nahaja na delu primorske avtoceste na odseku Klanec-Sermin. Po celi svoji dolžini 2150 m predor poteka v geološki zgradbi, v kateri dominira fliš. Fliš najboljše opišemo kot turbidit, ki je narejen iz spreminjajočih plasteh laporja in peščenjaka. Izkop in primarno podpiranje predora je bilo uspešno narejeno po principih NATM. Tehnološka sekvenca pri primarnem podpiranju je bila izpopolnjena z uporabo mikroarmiranega brizganega betona. To je pospešilo gradnjo in prineslo prihranke v uporabi časa, materialov in delovne sile, tako, da je bil izkop predora končan 4 mesece pred rokom. Dela na izvajanju armirano betonskih konstrukcij so bila tudi značilnega obsega in zahtevnosti. Približno na prvi in na drugi tretjini predora sta bila izgrajena dva razširjena prečnika. Le-ta omogočata preusmeritev celotnega prometa v predoru v primeru požara, kar je značilno za celotni sistem varnostnih ukrepov. Načeloma je bila leva cev predora postavljena zelo blizu površine terena, na določenih mestih pa je nadkritje znašalo samo okoli 6 m. Na lokaciji deponije Zamatavinec je leva cev prišla na površje in 60 m dolga armirana betonska konstrukcija je bila zgrajena po sistemu »cut and cover«. Zahtevna vzajemna interakcija med podpornimi

stenami, portalnimi konstrukcijami in nasipi, ki jo je narekovala geomorfologija na zahodnem portalu, je opisana v članku.

#### Geological Conditions and the Excavation of the Tunnel



Figure 1: The area of West Portal under construction



Figure 2: The structure of flish exposed in an open cut

In total, about 4300m of the twin Dekani motorway tunnel was excavated by drill and blast method in a single geological sequence of flish. Flish is a name, which is given to several different rocks that were formed at the same geological time under the similar geological conditions. Flish at Dekani is of paleogenic origin, with approximate age of 35 to 60 million years. Flish inherited its name from German word *fließen*, which means flow. The name and the specific structure of flish are attributed to the particular conditions in which those rocks originated. Flish was formed by the deposition of sediments into the deeper sea at the edge of continental plates. Underwater landslides and flows that were subsequently formed gave flish its characteristic structure. The macro structure of flish had been further re-formed by the intense tectonic forces, so that the rock mass features several sets of criss-crossing discontinuities, which at places significantly lower the self-bearing of the strata.

Predominantly, flish is made of conglomerates (breccias), sandstone and marl. The sedimentation of these layers and their sequence was dictated by the reduction of energy in underwater mudflow. In the typical section of flish a typical turbidite sequence can be found: intermittent layers of marl and sandstone of various thickness, ranging from several centimetres up to 2 metres. The typical sequence of layers in flish is shown in Figure 2.

The complexity of flish structure, the numerous discontinuities, and the presence of the perched water made up demanding conditions for the excavation of the tunnel. The rock conditions were classified as B1, B2, C2 and PC according to ONORM. The majority of excavation was carried out in the category B2 (about 65%) while C2 was at about 20%, B1 at 20% and remaining PC at about 5%. The elements of primary support were typical for the NATM method: sprayed concrete lining, steel arches and reinforcement meshes, which were complemented by the use of rock anchors.

**The Investigation Field and Use of Microfibre Concrete**

In order to improve the sequence of works the microfibre sprayed concrete was used as an alternative material for the primary support during the excavation. The aim was to replace steel arches and reinforcement meshes with the material that provides the early strength and stiffness of the primary lining along with the ability of the lining to take tension stresses. A 60 m long investigation field with the alternative primary support was introduced in the tunnel. The investigation field was equipped by the measuring profiles that included measuring anchors, extensometers and pressure cells, while the convergence measurements were carried out at every 10 m.

Relatively convenient geological conditions in the rock mass category B2 were chosen for the investigation field. The layers of sandstone varying between 20 cm and 1 m in thickness dominated geological sequence. Intermittently, between the sandstone layers, there were marl shale and occasionally mudstone shale, up to 5 cm in thickness. The particular sequence was not significantly affected by the tectonics, closed and rough discontinuities were perpendicular to predominantly horizontal layers. During the excavation, the geotechnical conditions improved and the rock mass was reclassified as B1. In that sense, the investigation field was only partly successful, as the main aim was to investigate the applicability of the microfibre sprayed concrete lining in more demanding geotechnical conditions.

The support measures in the rock mass category B2 consisted of 20 cm thick sprayed concrete (MB25) lining reinforced with one layer of steel mesh Q189. The primary support also included steel arches TH21 and the SN rock anchors  $\Phi 28$  mm with a nominal capacity of 250 kN. The support measures in investigation field used

microfibre concrete and the steel arches and reinforcement mesh was omitted. The length and distribution of the rock anchors remained unchanged. The supporting measures used in the investigation field are shown in Figure 3.

The results of geotechnical measurements in the investigation field showed moderate and uniform mobilization of strength of the surrounding rock. The vertical movements did not exceed 10 mm. The mobilization of the capacity of rock anchors was around 30%, protruding to about 5 m depths. Extensometer measurements showed that there was practically no movement below the same depth.

The results from the investigation field confirmed that the microfibre reinforcement was efficient in introducing ductility to primary lining thus preventing the initiation of micro fissures. The role of the omitted steel arches was also partly replaced by the quick gain of early strength of microfibre concrete, which was achieved by a careful selection of additives.

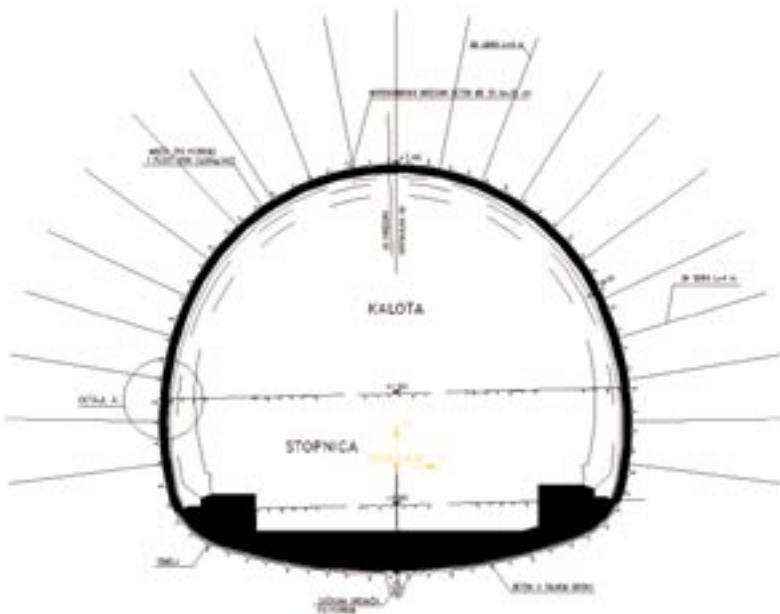

Figure 3: The support measures in the investigation field

The results of geotechnical measurements in the investigation field were further used for the back analyses. The aim was to back-calculate parameters that are representative for the support measures and the rock mass in the investigation field. The finite element analyses were carried out using program Phase 2. The rock mass was modelled as an elastic-plastic Mohr Coulomb material. The initial set of parameters was selected following the Hoek and Brown (1) classification for the particular rock mass category that was logged at the face of the tunnel. The input parameters were iterated in the analyses so as to provide the best fit for the measured data. The Hoek and Brown (1) classification was always considered, so that the iteration parameters never exceeded the range given for the particular rock mass classification. The back-calculated parameters, which can be regarded as applicable for tunnel excavation of given geometry in fliish for rock mass category B1, were as follows:  $c = 377 \text{ kPa}$ ,  $\Phi = 46^\circ$ ,  $E = 2065 \text{ MPa}$  and  $\nu = 0.25$ , where  $c$  is cohesion,  $\Phi$  is angle of shear resistance,  $E$  is Young modulus of elasticity and  $\nu$  is Poissons ratio. These were further used to define the supporting measures for another 400 m of the excavation of the tunnel, which was predominantly in the rock mass category B1. The successful use of microfibre concrete for primary lining along this section brought about considerable savings in the use of material, time and working force.

### The Reinforced Concrete Structures

The Dekani tunnel featured five cut and cover structures, four on the portals and a 60 m long cut and cover section at Zamatavinec depot. Three out of four portal structures were relatively small, up to 12 m lengths. The portal structure for the right tube at the West portal was up to 70 m long. In total, about 160 m of the tunnel was constructed using the cut and cover method.

Figure 4: The cross section of a retaining wall leading to the right tube of the West portal

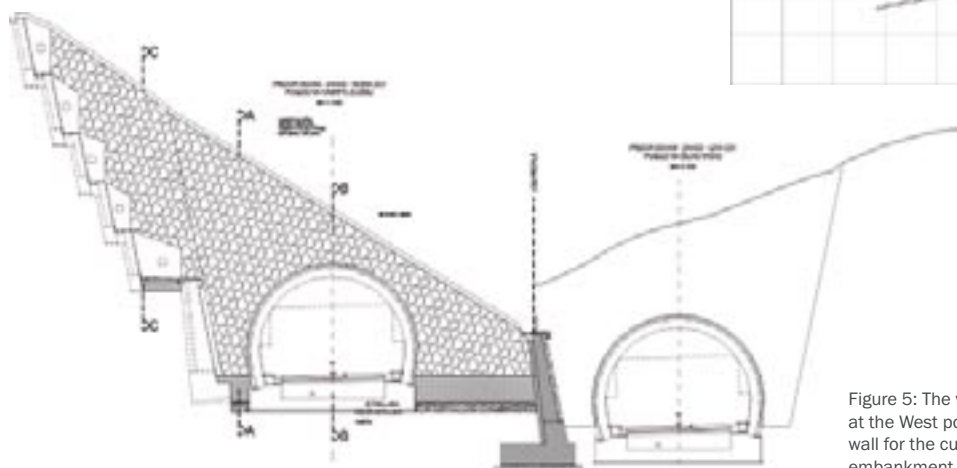

Figure 5: The view of the reinforced concrete structures at the West portal (two tunnel portal structures, retaining wall for the cut to the left and the retaining wall for the embankment material in between the two tubes)



The portal structure at the West portal, right tube, is particularly demanding due to an asymmetric load applied by the 11 m high embankments above it, which is inclined at a slope of about 35°. A 100 m long section leading towards the right tube is in the cut, which is protected by a 25 m high retaining wall. A second wall, which runs between the two portal structures, retains part of the embankments above the right tube. The vertical stagger between the motorway axes at that location is about 5 m. The cross section of the retaining wall and the east view of the four reinforced concrete structures at the West portal area are shown in Figures 4 and 5, respectively.

The axis of the left tube of the tunnel was positioned in parts to be very close to the surface, which at some location did not exceed 6 m. At the location of the Zamatavinec depot the left tube of the tunnel cropped up and the 60 m long cut and cover structure was constructed. This section coincided with the position of the first cross passage between the tubes, detail of which is shown in Figure 6, some 400 metres far from the East portal.

Figure 6: Detail of the Zamatavinec reinforced concrete structure and the cross-passage between the tunnels

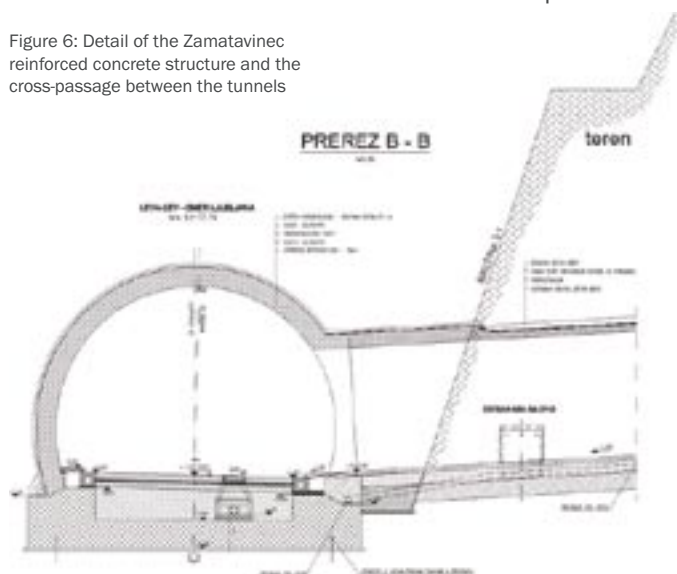

Convenient location of the cross-passage was used to improve the logistics of the works and introduce two more attacking points for the excavations. This also brought about savings in the removal and deposition of the excavated material, as the transport routes were made significantly shorter. Also, once the part of the left tube was broken through the further savings were made in the use of electrical supply due to a lesser demand for the ventilation.

The Zamatavinec cut and cover structure was built in about 22 m deep cut in the area of the existing landslide. The monitoring scheme was established and there was no sign of excessive movements of the slopes during the excavation works or later during construction. This was partly helped by the very dry weather conditions during the excavation. The embankment above the tunnel, shown in construction in Figure 7, was at certain locations up to 12 m high.

Two enlarged cross-tunnel connections between the two tubes were built inside the tunnel. These were constructed at the first and the second third of the full length of the tunnel at the location of the parking bays, which were at the same chainage in both tubes. The aim was to allow for the redirection of the whole traffic in the case of fire, including the double axis lorries and buses, thus contributing to the overall safety measures. The plan view of the one of the enlarged passages is shown in Figure 8.

Although lightly loaded exclusively by the self-weight, the secondary lining of cross passages was



Figure 7: Deposition of material at Zamatavinec »cut and cover« reinforced structure

demanding to build. The geometry of the lining in 3D is shown in Figure 9. At the widest section the span of the passage structure exceeded 18 m. No beams were used to provide the support for the lining of the parking bays, as 3D finite element calculations showed that the lining acts predominantly as a membrane, so the reinforcement was light.

To limit the costs, the forming was made in four segments, which were then used to concrete all eight quarters of two passages. The added complexity was the tunnel axes were vertically staggered, and the passages were inclined, up to 11%. The exact position of the forms was achieved with a vertical tolerance of about 1cm, while horizontal was lower, at about 5 cm.

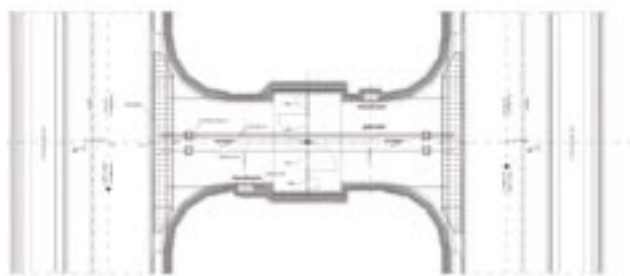

Figure 8: The plan view of the enlarged cross-passage between the tubes

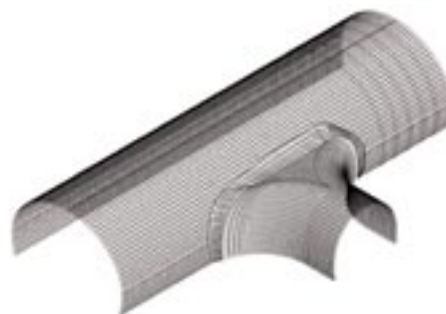

Figure 9: 3D geometry of the half of the cross-passage between the tubes

## Conclusions

The 2150 m long twin Dekani tunnel is the first motorway tunnel built in the fliš geological sequence in Slovenia. Drilling and blasting technique was used for the excavation of the tunnel, while the primary support was built according to the principles of the NATM method. At parts, this method was modified by the use of microfibre sprayed concrete lining. This proved to be a very efficient alternative for the primary support, bringing about the savings in time, material and the use of the working force.

Construction of Dekani tunnel involved several cut and cover sections, about 160 m in total. A 60 m long cut and cover section at Zamativinec depot was constructed at the location of the cross-passage between the tubes. This was convenient for the removal and deposition of the excavated material and further overall savings were made in the use of energy sources due to an easier communication and lesser need for ventilation.

The complex morphology at West portals demanded an elaborate design solution for the portal structures and complementing retaining walls. The tunnel also features two enlarged cross-passages for the diversion of the whole traffic in the case of fire. The lining of the cross-passages has a span of about 18 m and provides support for the lining of the parking bay. 3D finite element analyses were used for the design calculations of the secondary lining of the cross-passage. The analyses showed that the lining acted as membrane representing an efficient design solution, as only the light reinforcement was needed.

#### Literature

(1) Hoek, E. and Brown, E.T. 1997. Practical estimates of rock mass strength. *Intnl. J. Rock Mech. & Mining Sci. & Geomechanics Abstracts*. 34(8), 1165-1186.

## Sewage Tunnels in Singapore

Dr. U. Klotz, M.Sc.  
Züblin International GmbH, Stuttgart

In Singapore construction of the first phase of the „Deep Tunnel Sewerage Systems“ is well underway. Besides a water reclamation plant and a sea outfall, the system consists of 48 km of main sewers the so called deep tunnels and 70 km of Link Sewers which connect to the existing sewerage system. Completion of the works is scheduled for 2008.

The gravity driven main sewers have internal diameters between 3.3 and 6.0 m and an overburden of 20 to 60 m and are constructed in six contracts using tunnel boring machines. A dual internal lining system comprising a first layer of reinforced concrete segments as well as a secondary corrosion protection lining including a HDPE membrane ensure a maintenance free 100 year design life. The Link Sewers which range from 400 to 3000 mm in diameter are constructed using the Pipe Jacking Method.

Particular challenges during execution include the construction of access shafts next to infrastructure such as roads, rail and utilities as well as the extremely variable geological conditions. This required the development of new innovative construction methods.

### 1. Introduction

The city state Singapore is the logistic turntable of Southeast Asia and the most significant commercial centre of the region. The economic growth in the past years amounted between 5-8% per year. Studies of the Ministry for national development predict an increase of the population from today 3.8 to approx. 5.8 million in the year 2020.

As supporting measure for this expected population growth, in 1994 planning for a new deep-seated sewage system – the “Deep tunnel Sewerage system” – briefly called DTSS, begun. The system is realised in two phases and covers the new construction of two central waste water treatment and water treatment plants as well as approx. 65 km main and 170 km secondary sewers. The waste water flows with natural downward gradient in 50 m shafts at the sewage treatment plants and is then boosted for treatment. The project extent is shown schematically in Figure. 1.

Owner is the State of Singapore represented by the Public Utilities Board (PUB). The construction of the first phase of the DTSS began in 1999. The completion and commissioning are expected for 2008. The realisation of the second phase, which covers 17 km main sewer, 100 km secondary sewer as well as a purification plant, is planned between 2007 and 2015. Further details are in [1].

In the following construction of the first phase of the DTSS is described briefly. Ed. Züblin AG received the order for two projects of the first phase: a) Lot T-06: Main sewer Queensway tunnel and b) the secondary sewer “Upper Thomson Link Sewers”. These two projects will be dealt with in detail.

### 2. The DTSS Project – Phase 1

Figure 1: Overview of the Deep Tunnel Sewerage Project in Singapore.



### 2.1 Project Overview

The project extent of the first phase of the DTSS is schematically presented in Figure 1. Beside the Changi Water Reclamation Plant (CWRP) and the attached Sea Outfall the project covers a 48 km long main sewer constructed in six lots by means of TBM and 70 km of secondary sewers, which are constructed in 18 lots by means of pipe jacking.

On intersections of the main and secondary sewers shafts, fixed weirs, exhaust chambers and air cleaning equipment are foreseen depending on requirement. Additional shafts are intended for construction and maintenance purposes. In total 40 shafts are foreseen with final diameters between 1.8 and 3.0 m and depths up to 50 m.

The challenges during construction of the DTSS project are in particular the variable geology, with abrupt changes from weathered, soft granite to fresh hard granite in the central areas, and in the underpassing of highly frequented traffic infrastructure, like motorways and underground lines.

In early 1997 the contract for the feasibility study of the project (Main sewer and CWRP) and for the supply of the preliminary design including the alignment has been awarded to the Joint Venture CH2MHILL/Parsons Brinkerhoff.

The pre-qualification for the north as well as the Spur-tunnel was finalised in mid 1999, the tender phase for all six construction lots as per Design&Build contract model in early 2000.

Contract	Company / JV	Length m	OD m	ID m	C-Time Months
T-01 Changi Tunnel	Woh Hub - STEC JV	5,800	7.16	6.00	47
T-02 Bedok Tunnel	Penta Ocean Construction	7,700	7.16	6.00	50
T-03 Paya Lebar Tunnel	Kumagai-SembCorp JV	5,100	7.16	6.00	47
T-04 Ang Mo Kio Tunnel	Samsung Corporation	7,200	5.48	4.30	49
T-05 Kranji Tunnel	Holzmann-SembCorp JV	12,500	4.93	3.60	51
T-06 Queensway Tunnel	Ed. Züblin AG	9,600	4.46	3.30	50

Table1: Project Summary of DTSS Main Sewers.

Planning of the secondary sewers was assigned by the owner Public Utilities board (PUB) to a number of local and international engineering companies. For the execution, the traditional contract model “Build only” in accordance to the Standard Conditions of Contract for Public Construction Work in Singapore was applied.

In the tender for the construction lots of the main sewer contractors from Singapore, Japan, South Korea and Europe participated. For the secondary sewers mainly local companies were represented.

The first lot (Lot T-05) was awarded in December 1999 and the last (Lot T-06) in March 2000 to Ed. Züblin AG. The details of the construction lots for the main sewers are summarised in Table 1. The total contract volume of these lots amounts to approx. 260 million Euro.

### 2.2 Geology

The geology of Singapore is described in [2] and is extremely complex. In the south of the island as well as in river valleys soft marine sediments, like Marine or Estuarine Clay are present. Underneath, the Old Alluvium, a formation formed from the highly quartzcontaining weathering products of the granite, whose grains are angularly and

therefore extremely abrasive due to the short transportation distance before sedimentation, [3] - however most suitable concerning stability and degradability for conventional and machine tunnel construction. In the centre and the north of Singapore the Bukit Timah granite and its decomposition products, the Completely Weathered Granite (CWG) and the Residual Soil Granite (RSG) appear. In the west and south-west of the island the sedimentary rocks (sandstone and limestone) the Jurong formation are encountered.

For the tunnel construction work of the main sewers and due to the large depth Old Alluvium (lots T-01, T-02, T-03 and T-04) and Bukit Timah Granite (lots T-05 and T-06) respectively Jurong formation (lot T-06) became predominant. The secondary sewers are located in similar variable geological formations and in the south also in the Marine Clay and artificial backfilling.

### 2.3 Alignment and Design Concept

Singapore is a highly developed and closely populated country with excellent infrastructure. Therefore, it is of highest priority during the construction of the DTSS to ensure the functionality of the infrastructure (roads/rail/power/water/sewage) and in addition to minimise the impact on the residents due to emissions during construction and operation.

Due to this reason the route follows in general the traffic corridors in greater depth, in order to avoid intersections with existing buildings, supply lines and underground tunnels.

A further criterion was the reduction of the existing pumping stations. The entire DTSS was conceived as free flow system and the pumping stations were concentrated at the two treatment plants. As a consequence, a vertical alignment with overburden between 20 m in the central section and 50 m at the target points of the pumping stations was required.

The basic design concept for the main sewers aims at the minimisation of maintenance costs with maximum durability (100-year maintenance free design life). For this reason a secondary unreinforced inner shell the so called Corrosion Protection Lining or CPL is inserted inside the primary pre-cast segmental lining. The concrete of the CPL is lined with a 2,5 mm HDPE liner in order to increase the life span. Both

the thickness of the outer, segmental lining as well as the CPL is 25 cm. The HDPE lining covers 330 degrees of the circumference. Only at the bottom area of the dry weather discharge no HDPE is applied. A standard section of the main sewer is shown in Figure 2.

Figure 2: Schematic Cross Section of the Main Sewer.

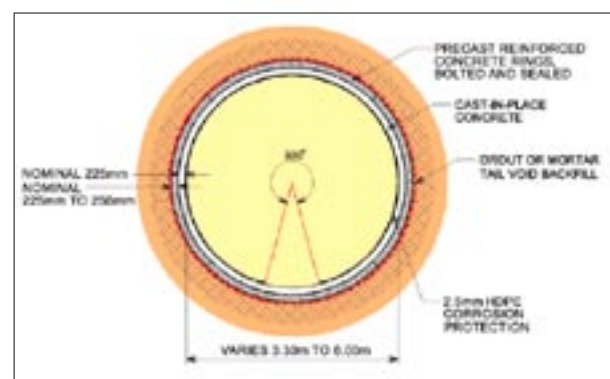

For the Link Sewers two types of pipes are used. The larger diameters (starting from ID 600 mm) are constructed with reinforced concrete pipes, the smaller diameters with stoneware pipes. The reinforced concrete pipe jacking pipes are likewise implemented with a HDPE lining for the increase of the durability. The concept of the HDPE lining is applied also to the shafts and crossing structures as well as to the shaft covers. The construction procedures are described in the following exemplary at the lots DTSS-T06 and Upper Thomson Link Sewers.

#### 3. DTSS Lot T-06 Queensway Tunnel

##### 3.1 Project Overview

In March 2000 Ed. Züblin AG, Singapore Branch received the award for the lot T-06 - Queensway tunnel. The route follows the traffic corridor Farrer Road, Adam Road, Lornie Road and Braddell Road, highly frequented and up to 8 lane highways. In addition, several roads underpasses, bridges, an underground line and a canal had to be underpassed. A further complication were the innumerable supply lines, in particular several lines for high pressure gas along the route. An overview of the alignment is shown in Figure 3.

A 9600 m long tunnel with an inside diameter of 3,3 m in a depth between 20 and 45 meters had to be constructed. In addition, 7 access and maintenance shafts with temporary/final diameters of 2,4/1,8 to 18/3.0 m and depths between 25 and 45 meters including the connecting tunnels to the main tunnel had to be built. Adjacent to shaft S a vortex chamber for the connection of a secondary sewer had to be constructed. A special issue for the design of the southern arrival shaft T is the connection to an existing sewer of ID 2100 and later to tunnels of the second phase of the DTSS scheme. In order to control the sewage flow at this location electromechanical slidegate valves are installed.

##### 3.2 Geology and Hydrogeology

Geological conditions along the route of T-06 are extremely complex. Along the tunnel axis from shaft T sedimentary rocks of the Jurong formation were encountered, changing into the Bukit Timah granite near Holland Road. Samples from the tunnel drive taken in fresh, unweathered conditions of the granite reached an axial compressive strength of more than 300MPa. Within ranges of strong decomposition (CWG and RSG) the material possesses characteristics of soil. These formations were found mainly between shaft S and R. From start shaft R to shaft R1 fresh and very strong granite was found. Between shaft R1 and the northern target shaft E the route lies mainly in the Old Alluvium.

Concerning settlements due to tunnelling – mainly the young, very compressible marine sediments are particularly critical due to their drainage. These formations were found within the range of the start shaft R, shafts S and R2 and the Holland Road underpass.

Groundwater appears along the route 2-3 m under natural ground level. Permeability of the layers Jurong formation, RSG, CWG and the Old Alluvium is approx. 10-6 m/s. In the granite the permeability can be very high along gaps and cracks and lead to a significant relaxation of the groundwater during the tunnel drive.

Figure 3: Projekt Overview of DTSS Contract T-06, Queensway Tunnel.

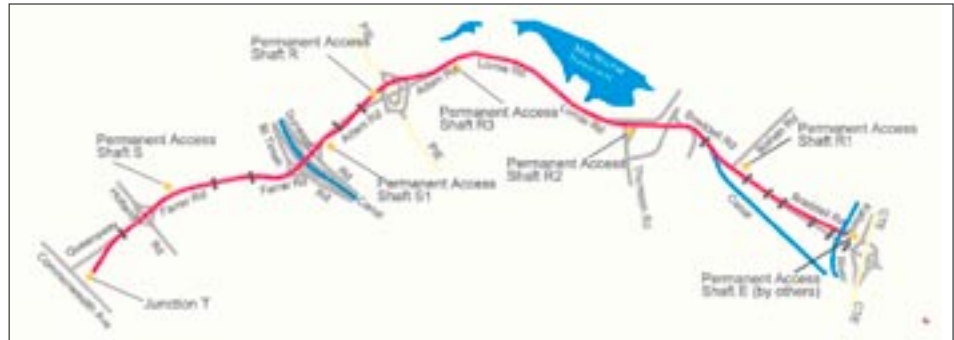

### 3.3 Tunnel Drive

The 9600 m long tunnel was driven with two identically constructed EPB - machines of the company Herrenknecht with an external diameter of 4.45 m (Figure 4). The machine has an output of 1250 kW. Due to the heterogeneous ground conditions a closed cutter head design was selected. Predominantly equipment with disc cutter which can be changed to drag bits if required. Conditioning of the soil can take place using foam or bentonite. Equipment for compressed air operation was available.

Figure 4: EPB TBM for Contract T-06.



Figure 5: Breakthrough of the South Tunnel.



The 225 mm thick and 1,3 m wide precast segments consist of 6 uniform sections, which are connected by means of pins. The annular gap is filled with cement grout. A seal against the high water pressure of up to 40 m water head is provided by a dual system consisting of a rubber profile and a hydroswellable seal.

To facilitate the launch of the TBMs two 60m long launch galleries were driven from shaft R using the shotcrete method. Subsequently, the machines were assembled and started first on 18 April 2004 with the north tunnel (5500m) and then on 20 May 2004 with the south tunnel (4100m).

The tunnel drive in particular in the north tunnel became extraordinarily difficult due to the very hard rock and the heterogeneity of the encountered formations. Changing layers from hard to weathered granite partly arose within a single ring and made highest demands on the TBM crew. In regular intervals the cutter and the screw conveyors had to be overhauled due to high wear. Additional complications were encountered during the underpassage of the highly frequented roads, bridges, underpasses, in particular with the Pan Iceland Expressway as well as the Holland Road and the Bukit Timah Channel.

Despite the difficult circumstances the tunnel drives were successfully completed. The breakthrough in the south took place on 18 September 2003 and in the north on 12 February 2004. The breakthrough of the southern machine is shown in Figure 5.

#### 3.4 Secondary Lining

After completion of the tunnel drive the installation of the inner lining commenced. For this work Züblin has developed a special shutter system in co-operation with the manufacturer Bystag, which is shown in Figure 6. In the south tunnel 6 shutters are used with a length of 7,5 m each. The production of the blocks takes place in an alternating sequence with three primary and three secondary blocks cast simultaneously. In the north tunnel 4 identically constructed shutters are used. The 30 degrees wide invert segment is cast in advance using a separate shutter system.

The concrete mix design was developed by the concrete technology department of Ed. Züblin AG. It is an almost self-compacting concrete with a compressive strength of 40 N/mm<sup>2</sup> (28 days), a water-cement ratio of 0.45 and a Slump of 200. The concrete is pumped from the concrete truck mixers to the concrete mixers in the tunnel and forwarded to the reloading point at the concrete pump. superplasticiser is added and the slump increased to 240 before the concrete is pumped into the formwork.

Figure 6: Shutters for the Secondary Lining.



The HDPE lining is manufactured and supplied by the South African company Engineered Linings, a holding of Naue Fasertechnik. Adjustment of the 2,5 mm thick and with anchorage burls provided HDPE plates is made on site by Green Cosmos, Singapore. The sheets are pre-assembled from individual panels at the surface and then transported in rolls into the tunnel.

The foil is stretched inside the tunnel first on a mechanised frame and then pulled onto the shutter. In order to prevent a warping during concreting, the foil is firmly tensioned at the ends. Figure 7 illustrates the work in the tunnel. After concreting the



Figure 7: CPL Lining inside the Tunnel

joints between the blocks are covered with a strip of HDPE - foil, which is welded with a robot.

The quality control plays a central role during the work on the inner lining. The program covers the fresh concrete quality, the bond between HDPE plate and in-situ concrete as well as the insitu concrete quality (density, strength, permeability). Extensive tests to check the bonding performance were successfully accomplished at the first blocks.

The short construction period available required an average installation progress for the inner lining of 17m/Day in the south tunnel and 20,6 m/Day in the north tunnel. This could successfully be achieved on the site owing to careful planning and sophisticated logistics.

#### 3.5 Shafts and Connecting Tunnel

The production of the seven shaft structures and connecting tunnels takes place parallel to the driving of the main tunnel.

Due to the dependence on geology and geometry a variety of optimised retaining systems were used. Shaft R was supported by means of a slurry wall, shaft R2 by means of a contiguous bored pile wall, shaft S and T by means of sheet pile walls and the small shafts R1, R3 and S1 by means of a pre-bored steel casing. The connecting tunnels were constructed by the shotcrete method.



The permanent structures of the large shafts T, S, R, and R2 as well as the connecting tunnels were built using the in-situ concrete and lined likewise with a HDPE sheets. For the ID 1800 mm shafts S1, R1 and R3 precast concrete parts of HDPE lining were used. The works on DTSS contract T-06 run on schedule. The hand-over to the Employer will take place in time.

#### 4. DTSS Upper Thomson Link Sewers

##### 4.1 Project Overview

The Link Sewer runs mainly along the Upper Thomson, Mandai and Sembawang Roads, which carry a high volume of traffic. In order to minimise the impact of the adjacent owners and the traffic during the execution of construction and in particular because of the depth required and difficult subsoil and groundwater conditions the sewer is constructed by the pipe jacking method. Figure 8 shows the layout plan of the project.

Figure 8: Layout of the UTLS Project.

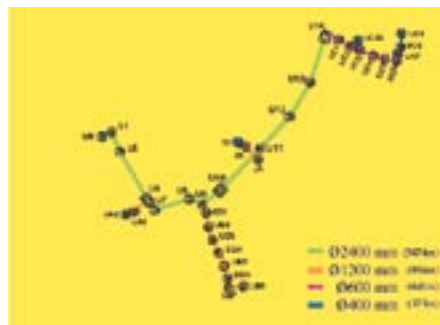

The contract comprises the construction of 32 start and target shafts with diameters from 4.4 m to 8.8 m up to 40 m final depth. In addition:

- 332 m Sewer ID 400
- 638 m Sewer ID 600
- 1,000 m Sewer ID 1200
- 3,072 m Sewer ID 2400
- 32 nos. Shaft Structures
- 1 no. Vortex Chamber

##### 4.2 Geology and Hydrogeology

In accordance with soil investigation report the main soil types encountered are fill, natural ground and bed rock. The geological conditions are comparable to those of the project T-06 and extremely complex.

The man made fill consists of different materials such as sand, gravel, silt, clay and construction debris. The natural ground consists of silty clayey sand, sandy clayey silt and sandy silty clay. Locally very soft organic layers can be encountered. Isolated large boulders and blocks of up to 60 cm width can be found. The rock formation consists of granite. Its compressive strength lies between 80 and 200 MPa. It is slightly to strongly weathered, and lightly to heavily jointed. These joints can be waterbearing.

On average the ground-water level lies 2 - 4 m below ground level.

##### 4.3 Shafts

The temporary start and target shafts consist of cylindrical reinforced concrete rings with a max. height of 2 m. The individual rings consist of segments, which are connected using tension rods. Hydro-swelling seals between the segments ensure the water-tightness of the shafts. The wall thickness corresponds to the static requirements.

The shaft rings are strutted using vertical tendons incorporated in the shaft walls.

This creates a quasi rigid hollow cylinder, which shows a favourable behaviour in particular for introducing the reaction forces of the pipe jacking frame. Soft eyes are located at the entrance and exit area of the shafts at pipe level to allow passing of the TBM.

Figure 9: Shaft Sinking at the UTLS Project.



The individual ring segments are placed, strutted with one another and lowered using the principle of open shaft sinking with simultaneous excavation of the soil. In order to decrease the skin friction between shaft wall and soil bentonite suspension is circulated in the gap. Up to 40 m deep shafts are sunk in this way. The sinking procedure is shown in Figure 9.

The permanent shafts are constructed using in situ concrete in the vicinity of the pipes and further upwards using precast concrete elements. Similar to the DTSS main sewer all structures are lined with HDPE membranes.

#### 4.4 Pipe Jacking Pipes

For the sewer ID 400 and ID 600 stoneware pipes are used. The pipes for ID 1,200 and ID 2,400 are reinforced concrete pipes with HDPE lining. The pipes ID 1,200 are manufactured in the centrifugally cast concrete, those with ID 2,400 in formwork. The pipes are produced in Malaysia by a local manufacturer. The works preparation and production control takes place via technical personnel of the Züblin Pipe Factories.

#### 4.5 Pipe Jacking

For the nominal sizes 400 mm, 600 mm and 1,200 mm slurry type AVN tunnelling machines are used. The length of these tunnel drives are up to 140 m.

The tunnel drives of 400 and 600 mm nominal size are located at shallow depth in the natural ground and can be driven without problems.

The ID 1,200 drives are located at a depth of up to 16 m under the ground surface also in natural ground. Occasionally boulders of up to 60 cm width have to be penetrated. This required the TBM to be equipped with a rock cutter head. The machine installed in the shaft is shown in Figure 10.

The link sewer sections in ID 2,400 are located in depths between 20 m and 40 m below the surface. The lengths of the sections vary from 73 m to 520 m. In these depths natural ground and rock are encountered. Literally from meter to meter the subsoil can change from silty sand, with and without groundwater, to hard dry clay, from soft silt, to hard or strongly weathered rock. The rock can be compact without groundwater, or, strongly jointed with very high groundwater flow within the joints. The groundwater level lies up to 40 m above the pipe invert.

These extremely changing subsoil and groundwater conditions can be found during the tunnel drive within a section. They represent a special challenge to the tunnelling method used.

Jointly with the manufacturer Züblin developed a new Dual Mode TBM to meet these challenging ground conditions. The TBM shown in Figure 11, can work in both earth pressure balance and slurry mode. Changing from one operation mode to the



Figure 10: AVN 1200 pipe jacking equipment mounted in the start shaft.

Figure 11: Dual Mode Pipe Jacking machine for ID 2400 Section.



other takes only few hours. First practical experiences with this machine will be reported in a different publication.

The work on the Upper Thomson Link Sewer is progressing on schedule and to the full satisfaction of the Employer.

## 5. Summary

With the construction of the Deep tunnel Sewerage System (DTSS) Singapore initiates the development of a state of the art sewage system with a design life of 100 years.

Complex geology and construction under highly frequented traffic infrastructure pose a significant challenge to the assigned contractors. With the construction of Lot T-06 and the Upper Thomson Link Sewers Ed. Züblin AG provides a substantial and successful contribution towards the implementation of the first phase of the DTSS project.

## 6. List of Literature

- [1] PUB Web Page [www.pub.org.sg](http://www.pub.org.sg)
- [2] Geology of the Republic of Singapore. PWD, Public Works Department, Singapore (1976)
- [3] Pitts, J. (1984). A review of Geology and Engineering geology in Singapore. Quarterly Journal of Engineering Geology, Vol. 17, 93-101.

## Gradnja predora Trojane v časovno odvisnih in nizko nosilnih kamninah Trojane Tunnel Construction in Time Dependent and Low Bearing Rocks

Prof.dr. Jakob Likar, univ.dipl.inž.

### Izveček

2900m dolg dvocevni predor Trojane je umeščen v prostor na avtocestnem odseku Ljubljana – Celje je trenutno še v fazi gradnje. Pričetek gradnje z vzhodne strani je bil v obeh ceveh izvajan kontinuirano do območja, ki je poseljeno. Predorski cevi imata ekvivalenten premer okrog 11m, medtem ko gradnja poteka na osnovi principov NATM. Zahtevne geotehnične razmere gradnje, majhna debelina nadkritja in prisotnost poseljenega območja nad predorskima cevema so dejstva ki sovpadajo in ki so vplivala na potek gradnje. Široko zastavljen opazovalni sistem, ki je bil postavljen na vseh ključnih objektih na površini kot so ceste, stanovanjski in gospodarski objekti, plinovodi, električne napeljave itd., je omogočal kontrolo deformacij, ki so bile povzročene z gradnjo predora. Sistema opazovanj v predoru in na površini sta omogočala določitev deformacijskega polja nad predorom.

Meljevec, glinovec in peščenjak so prevladujoče hribine, ki gradijo širše območje predora Trojane. Kamnine, ki gradijo območje Trojan, so tektonsko poškodovane in pregnetene pogosto preprežene s strukturnimi anomalijami ter mehкими vložki znotraj kamninske osnove. Hitre in pogoste spremembe v kamnini med posameznimi geološkimi sekvencami so povzročale potencialne zdrse in porušitve ter vplivale na težavne pogoje gradnje.

Izkop predora je potekal v štirih napadnih točkah na vsakem portalu na vzhodni in zahodni strani. Izvajanje je bilo s pomočjo hidravličnih kladiv in bagerjev s sprotim vgrajevanjem primarnih podpornih elementov, kot so jekleni loki, brizgani cementni beton z armaturnimi mrežami in hribinska sidra. V naslednjih fazah so bila izvedena ali so še v izvajanju druga gradbena dela kot so betonski temelji, talni obok, drenažni sistem, hidroizolacija, notranja obloga in cestišče.

### Abstract

The 2900m long twin Trojane tunnels, located on the motorway section AC A10 Ljubljana-Celje, are currently under construction. Starting from the east portal the construction works advanced on both tunnels to the most demanding section, this was immediately beneath the Trojane village. The tunnels are of about 11m diameter and are constructed using principles of the New Austrian Tunnelling Method (NATM). Difficult ground conditions, low overburden and the presence of the urban development above the tunnels all congregated at this particular section. A comprehensive monitoring system including roads, buildings, pipelines, electric cable towers and other communal infrastructure had been set up to enable control of the displacements caused by the tunnelling. The monitoring data were used to establish the surface and subsurface deformation field above the tunnels.

Mudstone, claystone and sandstone dominate the rock layering of the geological

sequence relevant to Trojan tunnel. The ground is tectonically reworked and damaged, contains structural anomalies and there are some very weak parties within the rock matrix. Sudden and frequent transitions between lithological sequences impose potential instabilities and make the excavation of the tunnel particularly difficult.

The construction of the twin tunnel was carried out at four advancing points, one at the end of each tube on both ends of the tunnel. The construction was carried out by the hydraulic hammer and machine excavations and the subsequent installation of the primary support, which consisted mainly of the steel ribs, the reinforced shotcrete and the rock bolts. The next phase was the construction of the invert and the foundations, followed by the installation of the drainage and the hydro-insulation. Finally, the construction of the secondary lining and the road pavement concluded the civil works.

## 1. Uvod

Trasa avtoceste je na območju Trojan speljana tako, da je prilagojena zahtevanim prometno tehničnim in okoljevarstvenim pogojem ter v manjši meri upošteva geološko geotehnične razmere v smislu iskanja manj zahtevnih pogojev gradnje.

Območje, kjer je v prostor umeščen dvocevni dvopasovni predor Trojan, ki je dolg okrog 2900m, je gričevnato in hribovito. V pretežni meri ga gradijo kamnine karbonske in permske starosti. Trasa predora, ki je sestavni del trojanskega odseka je bila izbrana na osnovi obsežnih prometno tehničnih študij in okoljevarstvenih zahtev, katere so imle bistven vpliv na odločitev o izbiri trase. Manj je bil upoštevan geotehnični kriterij izbora, saj so dotedanje izkušnje pridobljene pri gradnji v podobnih kamninah nakazovale zahtevno gradnjo. Vsekakor sodobni tehnično tehnološki postopki gradnje podzemnih objektov omogočajo izvajanje del tudi v tako zahtevnih geotehničnih pogojih, kot so prisotni na območju Trojan. Zahtevnost gradnje, ki je bila ocenjena pred pričetkom izvajanja del je sicer kazala na izjemno težke pogoje, vendar so nekatera dogajanja med gradnjo presešla predhodne ocene, tako da je bilo potrebno dopolniti tehnologijo gradnje s ciljem zagotavljanja primernih stabilnostnih razmer v predorskih ceveh ter zmanjšati velikost absolutnih deformacij na površini v vplivnem območju predora. Izkop in vgradnja primarne obloge sta zahtevala, glede na probleme, ki so se pojavljali med gradnjo, intenzivno vključevanje Geotehničnega sveta za predore in drugih eminentnih strokovnjakov s področja gradnje podzemnih objektov. Poleg navedenega je bilo potrebno dopolniti projekte, ki se nanašajo na nekatere elemente zagotavljanja varnosti v predoru, skladno z najnovejšimi avstrijskimi smernicami, saj je v vmesnem času od leta 1995, ko so bili izdelani projekti, prišlo do sprememb tudi zaradi nesreč, ki so se zgodile v predorih v Evropi. Na sliki 1 je prikazana situacija območja gradnje predora Trojan.

Slika 1. Lokacija predora Trojan.

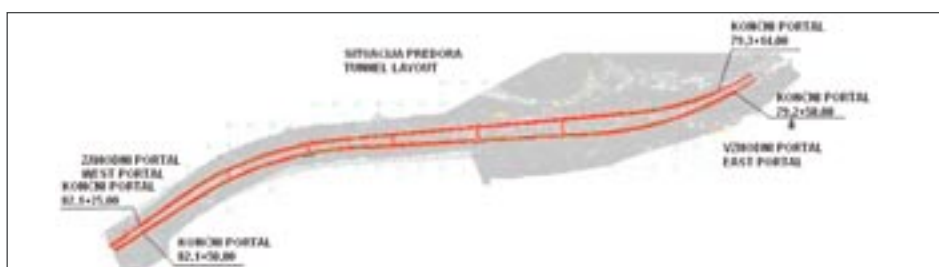

#### 2. Inženirsko geološke značilnosti območja

##### Trojan

Trojanski hrbet in širše območje v geološkem pogledu pripada karbonski in perm-ski starosti. Kamnine so v geološki preteklosti doživele velike mehanske spremembe kot posledica tektonskih dogajanj in drugih sprememb, tako da so v pretežni meri močno tektonsko poškodovane z značilnimi vertikalnimi in subvertikalnimi prelomnimi conami debelimi od nekaj dm do več 10m, katere zapolnjuje tektonska glina z nizkimi geotehničnimi karakteristikami. Premaknjene plasti se kažejo v različnih prostorskih legah z bolj ali manj izraženimi skrilavimi lastnostmi, ki še posebej vplivajo na pogoje izkopa in primarnega podpiranja, saj je v mnogih primerih vpad plasti usmerjen v izkopni prostor (območje Trojane zahod).

Slika 2. Značilna geološka prečna prereza predorske cevi Trojane zahod - leva predorska cev.

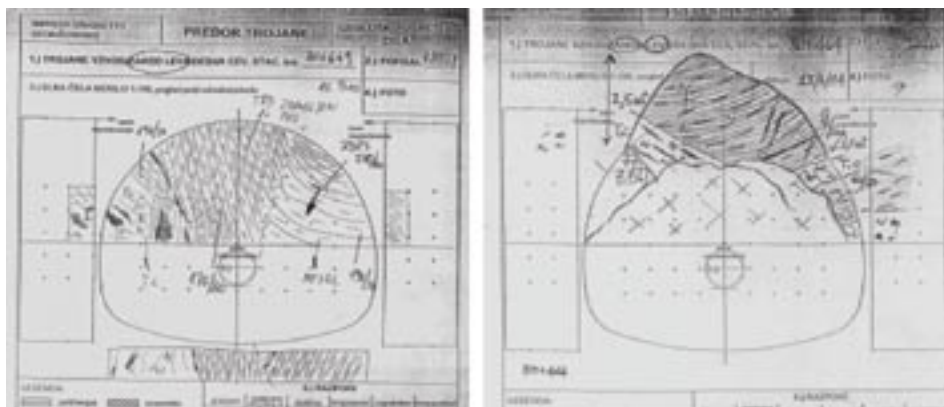

Preperinski pokrov, ki je v stabilnostnem pogledu najbolj problematičen, sega do različnih globin, odvisno od globine in intenzivnosti preperevanja v preteklih obdobjih. Tako imamo na nekaterih mestih globino preperinskega pokrova tudi do 17 m, medtem ko drugje debelina ne presega 1m. V geotehničnem smislu so dokaj pomembne tektonske anomalije, ki se razprostirajo v smeri SZ - JV in vsebujejo v največ primerih tektonsko glino, ki ima sicer določeno kohezijo, je pa deformabilnostno gledano precej manj toga kot so druge kamnine, ki se nahajajo na območju Trojan. Kot je bilo z izkopnimi deli ugotovljeno, so meljevci, glinovci in peščenjaki značilne kamninske plasti, katerih lega se pogosto spreminja, kar je posredno vplivalo na zagotavljanje stabilnostnih razmer v času gradnje predora. Prehodi iz enega plastovnega sistema v drugega so bili mnogokrat nepredvidljivi, še posebej tam, kjer je bilo to povezano z vertikalnimi preskoki, ki jih z vertikalnimi vrtninami ni bilo mogoče predhodno ugotoviti. Zato je bila sprotna geološko geotehnična spremljava in na osnovi tega izdelane sprotne analize, izjemnega pomena za pravočasno in učinkovito ukrepanje.

#### 3. Vhodi v predor Trojane

Na vzhodnem in zahodnem delu so vhodi v predor Trojane locirani inženirsko gledano v dokaj neugodnih kamninah. Dostopi v rudarske dele predora so pod ostrimi koti glede na pobočja in temu primerno so portalna območja sorazmerno dolga, zgrajena v značilnih kamninah, ki jih v pretežni meri sestavljajo tektonsko



Slika 3. Območje zahodnih portalov

poškodovani glinavci, meljevci in peščenjaki, pogosto zapolnjeni s hribinsko vodo, ki se nekontrolirano pretaka po razpokah. Prav ta pojav je dokaj neugoden, saj spremenljivo precejanje vode otežuje učinkovito vgradnjo drenažnega in odvodnjevalnega sistema. Na sliki 3 je prikazano območje zahodnih portalov.

#### 4. Tehnične posebnosti gradnje

Fazama gradnje predora, ki sta zajemali izkop in primarno podpiranje na štirih napadnih točkah, (preboj desne cevi je bil 01.10.2003 in preboj leve cevi je bil 26.3.2004), sledijo ostale gradbene faze kot so vgradnja temeljev in talnega oboka, priprava primarne obloge za namestitev zaščitne in hidroizolacijske folije, vgradnja notranje betonske obloge, odvodnjevalnega sistema za hribinsko vodo itd.

Značilni prečni prerez predorske cevi je prikazan na sliki 4, iz katerega sta razvidni velikost in oblika profila ter konstrukcijski elementi predora. Gradnja, ki je zajemala izkop in primarno podpiranje je poteka ob upoštevanju principov NATM (Nove avstrijske metode gradnje predorov) ob sprotne prilagajanju podpornih ukrepov spremenljivim geotehničnim pogojem gradnje.

Slika 4. Splošni prečni prerez predora.

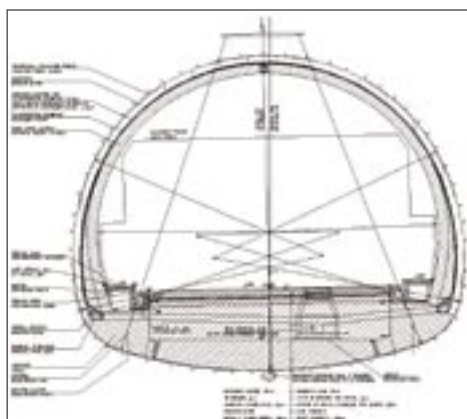

Geotehnične lastnosti kamnin in zemljin, ugotovljene med izkopom, ki gradijo Trojanski hrbet so dokaj spremenljive in v nekaterih primerih močno tektonsko poškodovane, tako da so večkrat odstopale od značilnega povprečja predvsem v smislu manjše samonosilnosti.

Prav slednje je bilo pomembno pri odločanju o izbiri mehanizacije in druge opreme, ki se je uporabljala pri izkopu in vgradnji podpornih elementov. Pri izkopu predora je uporabljena mehanizacija opremljena z odkopnimi hidravličnimi kladivi, omogočala še primerno hitrost napredovanja in v primerih, ko je bila hribina dovolj mehka, so bili uporabljeni tudi navadni bagri v stopnici in talnem oboku. Pri tem je potrebno pojasniti, da Izvajalec del ni uporabljal predorskih bagrov, ki se pogosto uporabljajo za izkop v tovrstnih kamninah.

Slika 5. Nameščanje jeklenega loka K24.

Slika 6. Vgradnja talnega oboka iz brizganega cementnega betona MB25 debeline 35cm.



## 7. mednarodno posvetovanje o gradnji predorov in podzemnih prostorov

### TEMA 2 | NAČRTOVANJE KONSTRUKCIJ IN VZDRŽEVANJE PODZEMNIH PROSTOROV

Hitrost izkopa je različna odvisna od trdote, trdnosti in žilavosti kamnine, tako da traja izkop kalote, ki ima prečni prerez okrog 53m<sup>2</sup> od 2ure do 5ur. Pri tem igra veliko vlogo pravilno odpiranje prostih ploskev v plastovitih kamninah, kar omogoča učinkovit izkop. Lastnosti kamnine zahtevajo takojšnjo vgradnjo podpornih elementov, kot je prikazano na sliki 5, na sliki 6 pa vgradnjo talnega oboka iz brizganega cementnega betona MB25 debeline 35cm.

Slika 7. Način izkopa in odpiranja ploskev v plastoviti kamnini – primer asimetričnega sidranja.

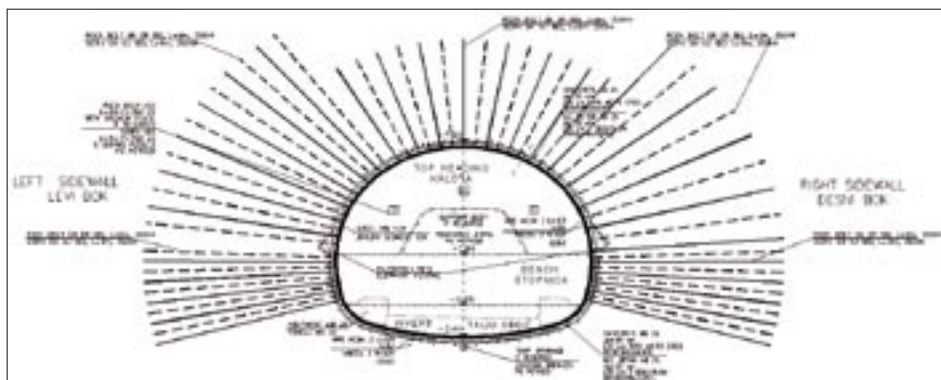

Ker so lastnosti nastopajočih kamnin takšne, da imajo izjemno nizko samonosilnost in da uporaba vrtanja in razstreljevanja ni bila potrebna, je pa bila nujna vgradnja močnejšega podporja oz. kombiniranega podpornega sistema, ki prenaša dodatne obtežbe okoliških kamnin.

Slika 8. Vgradnja IBO sider v izkopno čelo.



Slika 9. Vgradnja mikropilotov v desni bok predorske cevi.



V pretežni meri so bili uporabljeni standardni podporni elementi kot so brizgan cementni beton MB25 debeline do 35cm, hribinska pasivna sidra (SN, IBO) z nosilnostjo 250kN in 350kN, armaturne mreže Q189 in Q283 ter jekleno ločno podporje (TH21, K24) ter pomožni podporni elementi kot so jeklene sulice, jekleni cevni ščit (slika 11), začasni talni obok iz brizganega cementnega betona, razširjena peta v kaloti, jekleni mikropiloti (slika 9), ipd.

Sistem izkopa in podpiranja je bil prilagojen spremenljivim geotehničnim pogojem gradnje in tehnološkim posebnostim, ki so jih narekovala izjemno zahtevne hribinske razmere. Pojavi iztiskanja kamnin in časovno odvisnih sprememb napetostnih in deformacijskih polj ter posledičnega razvoja pomikov ostenja predorskih cevi in okoliških kamnin so bili zelo pogosti. Poleg iztiskanja in diferenčnega posedanja kalote, ki sta pri gradnji predora Trojane dokaj pogosta, se v nastopajočih kamninah pogosto pojavljajo povečane preostale napetosti v kamninskih gmotah, ki povzročajo asime-



Slika 10. Pričetek izkopa povoznega prečnika



Slika 11. Priprava na vgradnjo jeklene- ga cevnega ščita

Slika 12. Primer večjih diferenčnih pomikov v kaloti



trične obremenitve podpornega sistema, pospešeno posedanje kalote in deformiranje predorske cevi v različnih smereh.

Ti vplivi so dokaj neugodni za vzdrževanje stabilnih razmer. Kadar se seštevajo so težko obvladljivi ter predstavljajo najneugodnejše stanje v predoru. Ukrepi za obvladovanje težav s stabilnostjo se morajo izvajati pravočasno,

hitro in učinkovito saj potegnejo za seboj poleg vgradnje dodatnih podpornih elementov, izmed katerih so najpogosteje uporabljena sidra, tudi manjše hitrosti napredovanja izkopa in primarnega podpiranja.

Na sliki 12 so prikazane deformacije v merskem profilu iz katere se vidi problematika gradnje v anizotropnih pogojih ob velikih absolutnih in diferenčnih pomikih.

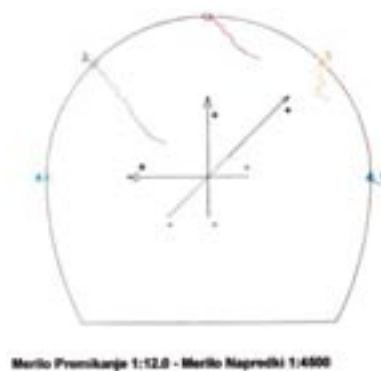

## 5. Spremembe napetostnih in deformacijskih stanj v kamninah okrog izkopnega čela

Napredovanje izkopa v nizkonosilnih in tektonsko močno poškodovanih kamninah, kot so glinavci, meljevci in tektonske gline, ki gradijo območje Trojan, je bilo povezano z velikimi vplivi oz. spremembami deformacijskih polj pred izkopnim čelom in širšem območju okrog predorske cevi. V močno zaglinjenih in relativno mehkih kamninah oz. trdih zemljinah, je ta vpliv segal tudi 3D ali celo 4D pred izkopnim čelom, če je D ekvivalentni premer predorske cevi. Ta pojav je bil izjemno neugoden, saj je izrazito vplival na absolutni časovni razvoj posedanja na širšem območju. Iz dosedanjih analiz in inženirskih interpretacij sledi, da vsebnost večjih količin glinastih komponent bistveno vpliva na časovni potek deformacij, kar je izjemnega pomena za pravilno oceno možnih sprememb v daljšem časovnem obdobju.

Zato je gradnja pod poseljenim območjem, kjer je bil uporabljen prilagojen podporni sistem v hribinski kategoriji SCC2, še posebej zahtevna – slika13.

### 5.1 Statične analize napetostnih in deformacijskih polj za potrebe izračuna deformacij na površini

Sodobni računski postopki sloneči na numeričnih metodah omogočajo hitro in kakovostno ugotavljanje sprememb, ki so posledica izkopa in vgradnje podpornih elementov pri gradnji predora. Vendar v posebnih primerih, kot je npr. Predor Trojane, so prognoze in rezultati tovrstnih izračunov pogojno uporabni. Vsekakor vhodni podatki, ki jih dobimo na osnovi različnih standardnih laboratorijskih in »in situ« raziskav niso

Slika 13. Podporni sistem v dopolnjeni hribovski kategoriji SCC2

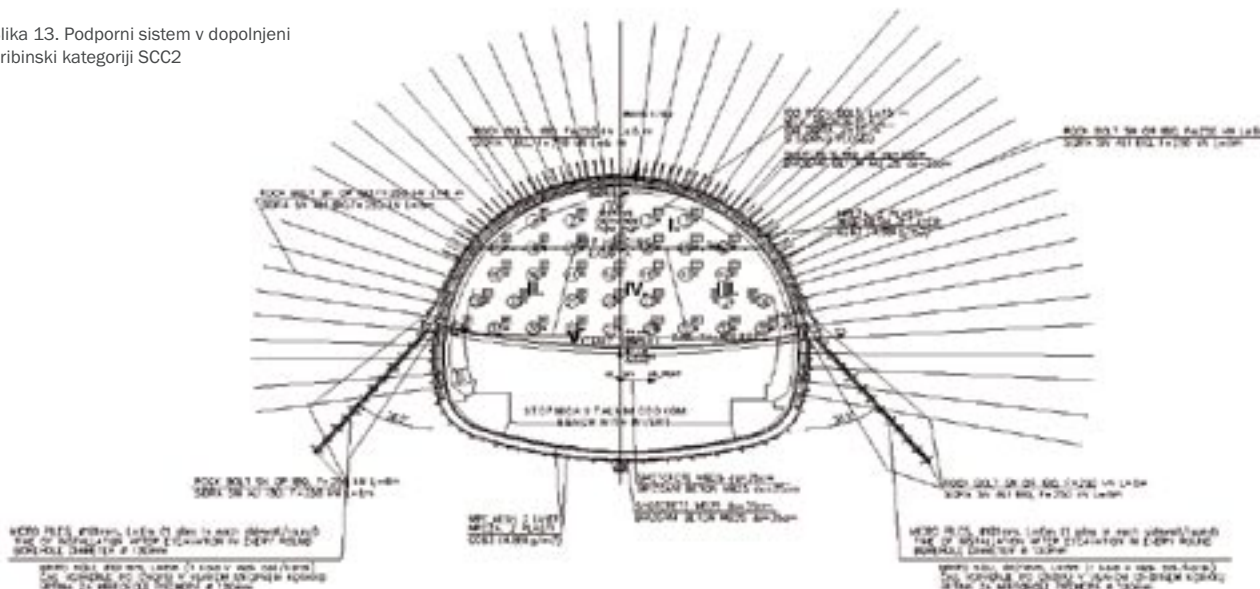

vedno povsem realni in ne dajejo pravih vrednosti, če primerjamo dejansko dogajanje med izkopom in podpiranjem predora. Te ugotovitve so jasno dokazane pri predoru Trojane predvsem v tistih odsekih, kjer je vsebnost glinastih komponent večja v primerjavi z drugimi odseki, ki imajo večjo vsebnost meljaste in peščene komponente. V vseh dosedanjih izračunih, ki so bili narejeni v okviru prognoznih ocen deformacij, so bile izračunane absolutne vrednosti precej manjše od kasneje izmerjenih med samo gradnjo. Izmerjeni diferenčni posedki pa so se bolj ujemali z izračunanimi, tako da so bili v večini primerov celo manjši od prognoziranih.

Iskanje vzrokov, ki so bili najpomembnejši, da je prišlo do večjih razlik med prognoziranimi in izmerjenimi deformacijami, nas je pripeljalo do naslednjih ugotovitev:

- z dvodimenzionalnimi analizami se ne upošteva 3D učinka, kar je v tovrstnih kamninah izjemnega pomena;
- vhodni parametri – predvsem deformabilnostni – ugotovljeni s standardnimi laboratorijskimi in »in situ« raziskavami ne ustrezajo realnim lastnostim, ki jih imajo nastopajoče kamnine.

Poleg navedenega uporaba dvodimenzionalnih statičnih analiz za ugotavljanje posedanja oz. deformacijskih sprememb zahteva – če hočemo, da so izračuni kolikor toliko skladni z izmerjenimi vrednostmi – bistveno znižanje vrednosti vhodnih parametrov. Na sliki 14 prikazujemo v shematski obliki vpliv izkopa na površino nad predorom.

#### 5.2 Vpliv togosti podpornega sistema in kamninskega stebra pred izkopnim čelom

Neodvisno od navedenega je vpliv togosti podpornega sistema na velikost in časovni razvoj deformacij velikega pomena za ustrezno dimenzioniranje tehnološkega procesa gradnje. Povečano togost primarne obloge lahko dosežemo na več načinov, kot npr:

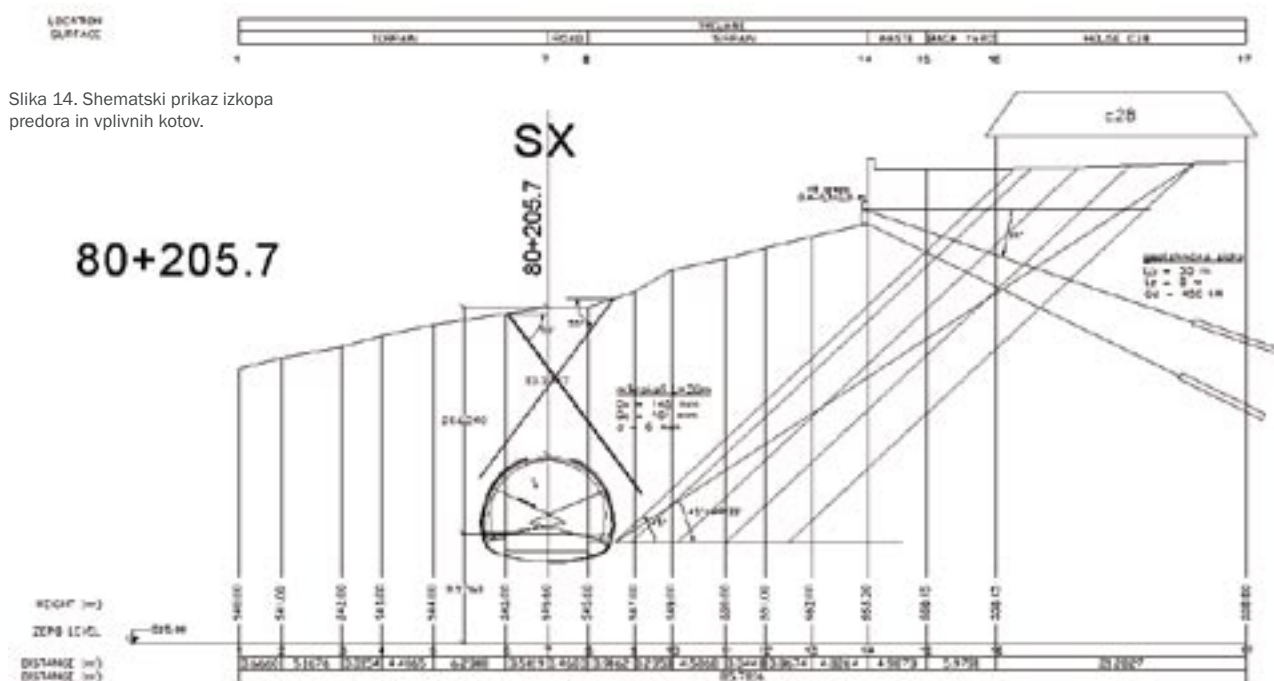

Slika 14. Shematski prikaz izkopa predora in vplivnih kotov.

- z vgradnjo podpornega sistema, ki zagotavlja hitro prevzemanje dodatnih obtežb, ki so posledica izkopa;
- z načinom izkopa in podpiranja po delih npr. način izkopa s stranskimi rovi, kjer je vzpostavljeno ravnovesje v manjših prečnih prerezi;
- z vgradnjo dodatnih nizko deformabilnih pomožnih podpornih elementov npr. povečanje togosti kamninskega stebra pred izkopnim čelom;
- kombinacija nekaterih navedenih.

Način izkopa, ki je bil uporabljen na nekaterih odsekih pri gradnji predora Trojane, kot kombinacija togih podpornih elementov v primarni oblogi in zaščita izkopnega čela z brizganim cementnim betonom debeline 15cm ter hribinskimi sidri dolžine do 15m z nosilnostjo 250kN, se je izkazal kot primeren, v danih geotehničnih pogojih.

Izvedena zaščita izkopnega čela s podpornimi elementi je bila takšna, da je bila še omogočeno normalno odvijanje tehnološkega procesa izkopa in podpiranja. To dejstvo je bilo bistvenega pomena za normalno izvajanje del s ciljem čim manjših prekinitev oz. čim bolj kontinuiranega dela pri napredovanju gradnje.

## 6. Rezultati meritev in opazovanj

Gradnja v hribinsko zahtevnih in povrh tega še poseljenih območjih je zahtevala stalno mersko preverjanje dogajanj v predoru in na površini. Sodobne geometrične metode opazovanj prostorskih pomikov so omogočile hitro in kakovostno izvajanje meritev ter pregledno predstavitev rezultatov. Tak način dela je sicer zahteval stalno prisotnost projektanta, je pa bil učinkovit in je zagotavljal pravočasno ukrepanje. Prav to je pomembno, saj bi prepozno odzivanje lahko imelo za posledico povečane pomike na površini in s tem bi lahko nastale potencialno večje poškodbe na objektih.

Opazovalna mreža na vplivnem območju predora Trojane in v predoru je bila sestavljena iz več sistemov opazovanj:

- a) na površini
  - repernih točk v osi predora za opazovanje posedanja in prostorskih pomikov;
  - prečnih merskih profilov, ki jih sestavljajo reperji, ki so postavljeni prečno na os predora za potrebe ugotavljanja širine deformacijskega polja;
  - vertikalnih inklinometrov za merjenje horizontalnih pomikov po globini;
- b) v predorskih ceveh
  - reperjev za merjenje prostorskih pomikov;
  - več točkovnih ekstenzometrov;
  - merskih sider in
  - horizontalnega inklinometra za merjenje časovnega razvoja in velikosti posedkov pred in za izkopnim čelom.

Slika 15. Razpored merskih mest na površini nad predorsko cevjo.

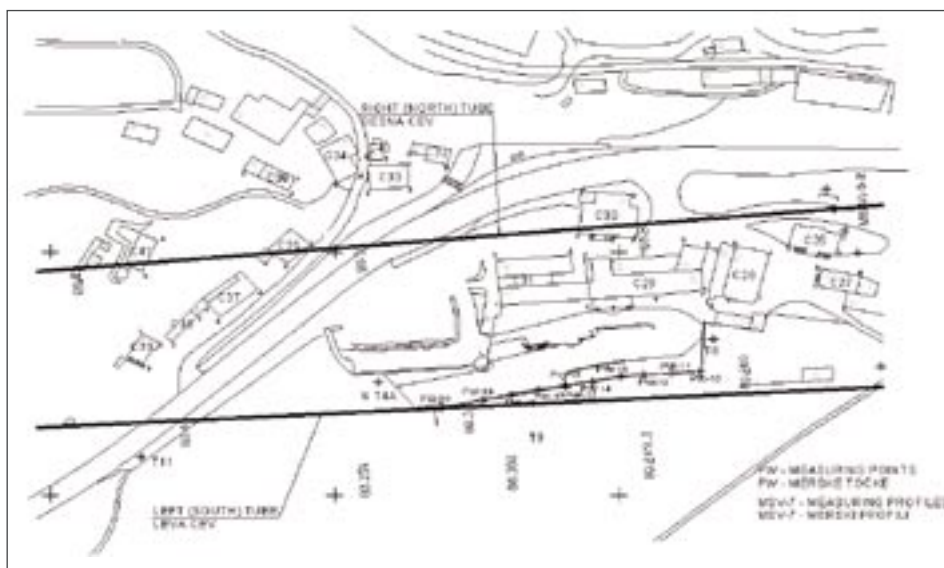

Na sliki 15 je prikazan razpored merskih mest na površini nad predorsko cevjo.

Izvajanje meritev na površini nad predorom in v predoru v horizontalnem inklinometru je bilo izvajano dvakrat na dan z namenom, da se je natančno ugotovilo, pri katerih fazah izkopa in podpiranja so se razvile največje deformacije pred in kasneje za izkopnim čelom. Iz diagrama, ki prikazuje odvisnost med posedki in napredovanjem izkopa v kaloti ter fazami izkopa je razvidno, da so bili pomiki največji od 2m do 6m pred izkopnim čelom in so bili posledica:

- deformiranja kamninskega stebra pred izkopnim čelom,
- sproščanja deformacij v smeri izkopanega dela predora v času faznega izkopa.

Ocenjeno je, da je bil ta odnos med posedanjem in horizontalnimi pomiki enak 40: 60. To dejstvo je pomembno tudi zato, da so bile ustrezno določene velikosti izkopnih faz in število hribinskih sider, vgrajenih v kamninski steber pred izkopnim čelom.

Slika 16. Fazni izkop v kaloti v hribinski kategoriji SCC2 v predoru.

17. Izmerjeni pomiki v hribinskem stebru pred izkopnim čelom.

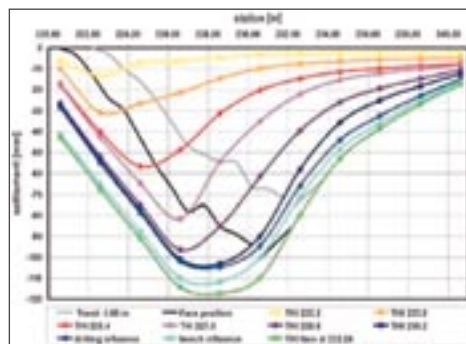

## 7. Povzetek

- Tehnologija gradnje predora v izrazito časovno odvisnih kamninah, ki je upoštevala principe NATM, je bila prilagojena izjemno zahtevnim geotehničnim pogojem gradnje.
- Največje težave pri gradnji so povzročale primarne - preostale napetosti v kamnini in neugodna lega skrivalosti in plastovitosti glede na smer napredovanja. Ti pojavi so se kazali v pogosti nestabilnosti izkopnih čel in povečanih nateznih napetosti v primarni oblogi.
- Posebna pozornost in dopolnjen način gradnje je bil namenjen izkopu tistih odsekov predorskih cevi, ki so potekali pod stanovanjskimi objekti in drugimi infrastrukturnimi objekti.
- Cilj prilagajanja načina izkopa in podpiranja je bil čim večje zmanjšanje pomikov v sistemu hribina - podporje, kar je zahtevalo fazni izkop in povečano togost primarnega podpornega sistema vključno z vgradnjo pomožnih podpornih elementov.
- Kakovostna geološka in geotehnična spremljava je bila trdna oporna točka, ki je omogočala hitro in argumentirano ukrepanje.

## 8. Zahvala

Na tem mestu se iskreno zahvaljujem vsem, ki so in še tvorno sodelujejo pri gradnji najzahtevnejšega in najdaljšega dvopasovnega predora v Republiki Sloveniji, še posebej pa upravama DARS,d.d. in DDC, d.o.o. za vso podporo v prelomnih trenutkih.

## Literatura

(1)Likar, J (2000,2001,2002,2003,2004). PZI PREDOR TROJANE na AC A 10; Načrt gradbenih konstrukcij. Investitor DARS,d.d.; Izvajalec gradbenih del: Grassetto,S.p.A., IRGO Consulting, d.o.o. Ljubljana

Prof.dr.Jakob Likar, univ.dipl.inž.  
Univerza v Ljubljani  
Naravoslovnotehniška fakulteta,  
Aškerčeva 12, 1000 Ljubljana

## Extension of Metro Line U2, Contract Section U2/1- “Schottenring” a Metro Station Under the Danube Canal

Dipl.-Ing. Herwig SCHÖFER  
PORR TUNNELBAU GMBH  
Absberggasse 47, 1103 Wien, Austria  
Tel: +43/50 626/1567  
Fax: +43/50 626/2088  
Email:herwig.schoefer@porr.at

Co-Authors:  
Christof Haberland  
Istvan Magyar  
PORR TUNNELBAU GMBH

### Abstract

Vienna's metro system is at present being extended in a third development phase. This comprises, apart from the extension of the U1-North line by 4.6km, a more-than-9km extension of the U2, now linking the city centre with the Prater park, to Aspern in the north-east of Vienna.

The first construction phase for the metro line extension project is Section U2/1 – “Schottenring“, which includes a metro station under the Danube Canal.

Driven by use of the NATM, the new extension of Line U2 will start from the existing Schottentor station, run under the Ringstrasse, cross Line U4, continue under the Danube Canal and end in an exit shaft on the left-hand bank.

The central feature of Contract Section U2/1 is the Schottenring station to be built under the Danube Canal near the so-called “Kaiserbadschleuse” which, constructed between 1901 and 1906 as part of a planned series of locks, has practically never been in service.

The station tubes with an excavated face area of about 76m<sup>2</sup> are being driven full-face under the shelter of soil freezing and, outside the freezing zone, as multiple headings with side wall drifts.

This paper reports on the present site activities.

### 1. General

The Vienna Metro extension project has reached its third phase. Apart from extending the U1-North line by 4.6km, from the UNO City district to the residential areas at the northern fringe of Vienna, the project provides for a 9km extension of the U2 line from the city centre from the existing Schottenring station by the Donaukanal to the Prater park and beyond, as far as Aspern in the north-east of Vienna.

The contract section I am discussing here forms part of the connection between the existing U2 line and the new line to be built in the direction of Prater and the Ernst Happel soccer stadium.

The contract includes the widening and deepening of the existing metro tunnel, which was constructed in open cut. The following section is a two-track mined tunnel which passes beneath the buildings on both sides of Ringstrasse and leads to the new Schottenring station close to the existing U2/U4 station.

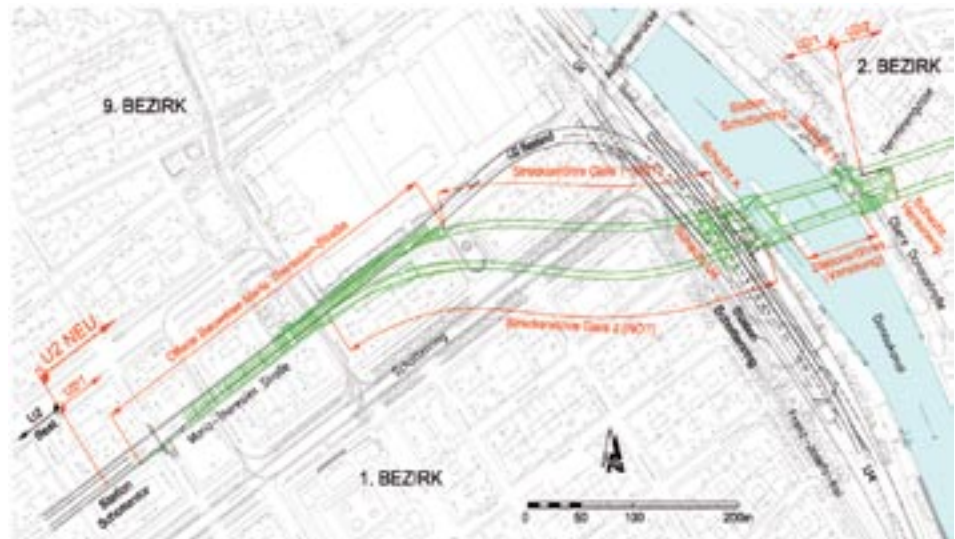

Longitudinal section Lot U2/1

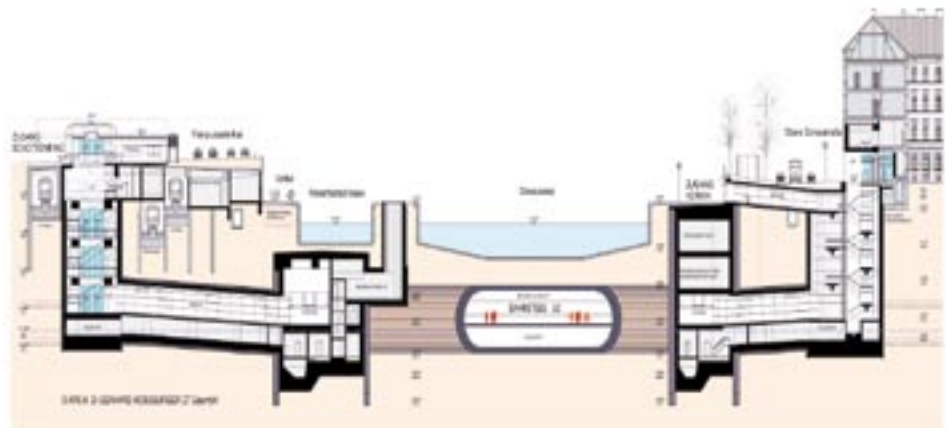

Several problems have to be faced in this contract section:

- The work has to be carried out while metro traffic is being maintained.
- The location of the new station under the existing U4 station presents a particular challenge. The underground station under the Danube Canal is the main feature of the project. It is being built by use of mining techniques, with shafts for access. The two tubes of 72m<sup>2</sup> cross section are constructed with the use of ground-freezing.

## 2. Description of the Individual Construction Phases

### Widening and deepening the existing Metro tunnel

The tunnel is being built in open cut using overlapping pile walls and covered with a T-beam slab.

The work for widening and deepening the existing tunnel has to be carried out while metro traffic is being maintained and in the centre of the densely built-up Vienna City.

We have to cope with the continuously changing dimensions of the beams, and there is a troublesome lack of space: in some places the space available for the form-

work and scaffolding for the beams, which are 1.5m high and up to 10m long, is not more than 30cm.

The formwork transporter has a highly mechanical design to meet the very complex geometrical requirements. With its help it is possible to lower, advance and re-position the formwork unit during a 3-hour night stop in Metro traffic.

Almost all the specialist civil engineering techniques available at the moment are being used for building this combined open-cut and mined underground structure in the midst of the densely built-up Vienna City.

Bore-piling, jet-grouting, diaphragm walling, sheet piling, anchors, water-table lowering, shotcrete shafts – all these techniques are required for implementing this project.

The presented pictures should convey some impression of the current specialist civil engineering activities.

Jet-grouting work and well construction from the basements of existing buildings are required to lower the groundwater level. The drainage piping, 400mm in diameter, is laid in sewerage tunnels.

#### **The station under the Danube Canal**

This underground station under the Danube Canal is the most critical feature of the contract. It consists of two tubes of 72m<sup>2</sup> cross section each and the adjacent shafts.

The following photomontage shows the shafts on either side of the Danube Canal and the tunnel tubes in between. In this area are two buildings under a preservation order, the "Kaiserbad lock and the "Wehrschützenhaus", an art nouveau (or Jugendstil) building by Otto Wagner.

We considered several construction methods for crossing the Danube Canal:

- Damming the Canal altogether and building the project in a dry pit.
- Reducing the discharge cross-section of the Canal and constructing the project in two or three phases.
- Working underground only by use of grouting to ensure impermeability, and pressed-air tunnelling.
- Working underground only by use of ground freezing.

These possibilities were tested for environmental compatibility. The ground-freezing alternative proved to be the most adequate technique.

#### **The shafts on either side of the Danube Canal**

The shaft to the left of the Danube Canal is about 20m deep and about 45m by 12m in plan.

The building pit is supported by a bored piling wall with jet-grouted joints. The shaft is built as a cut-and-cover structure with two stiffening levels.

The photos show the lock island with the lock gate and the gate house at the beginning of construction work in May last year. The Kaiserbad lock was built between 1901 and 1906 in a dry pit and was the first unit of a planned series of locks in the Danube Canal for shipping. The First World War brought this ambitious project to a



Photomontage of shafts and tunnel-tubes

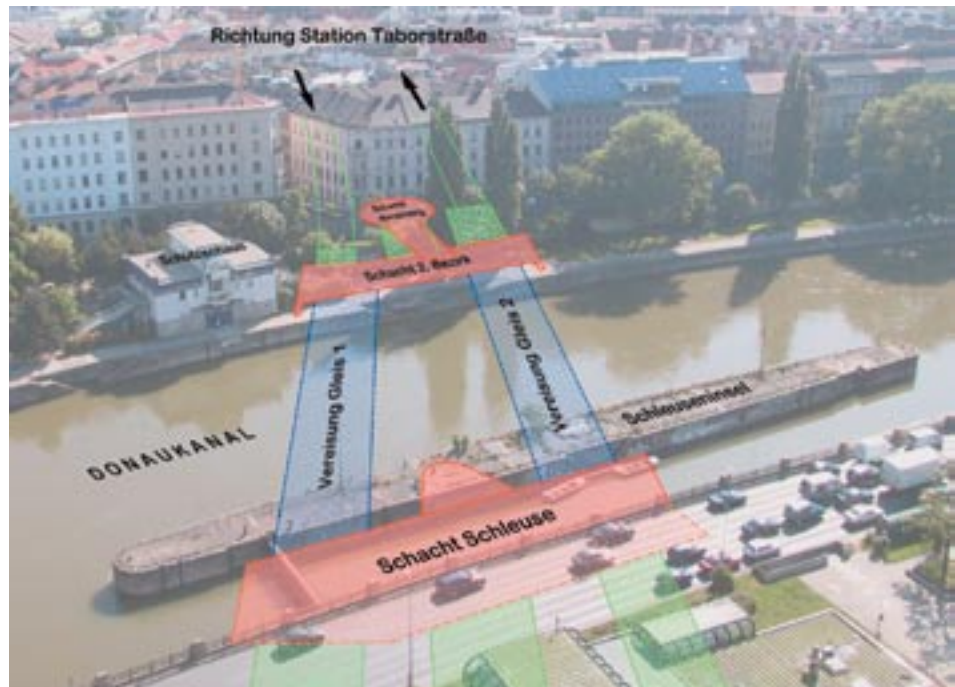

standstill. The lock is now under a preservation order and has to look exactly the same after the end of the work.

Historical photos from the time when the lock was built show, how people worked a hundred years ago at this construction.

#### **The shaft on the right-hand bank near the old lock**

A longitudinal section through the lock island on the side of the lock chamber shows the situation with the structure currently under construction - that means - we are building a cut-and-cover shaft into the old lock.

The cross-section through the shaft shows, what problems are caused by the water-pressure from the Danube Canal. This means that the diaphragm walls have to be installed from a higher level.

The sequence of construction activities for building the shaft will be shown in pictures

#### **Building the tunnels under the Danube Canal, using ground freezing**

This section through the two tubes under the Danube Canal shows the shallow cover of not more than 4.30m which separates the tunnels from the bottom of the Danube Canal.

The project provides for two freezing circles. The inner ring is produced by brine freezing, the outer ring by nitrogen freezing. The concrete structure above Track 1 is the bottom of the barrage in the Danube Canal.

Ground freezing is applied to make the underground opening impermeable to groundwater with its unknown seepage paths, and to provide an auxiliary arch in both

## 7. mednarodno posvetovanje o gradnji predorov in podzemnih prostorov

### TEMA 2 | NAČRTOVANJE KONSTRUKCIJ IN VZDRŽEVANJE PODZEMNIH PROSTOROV

Cross section of the ground freezing tunnel tubes

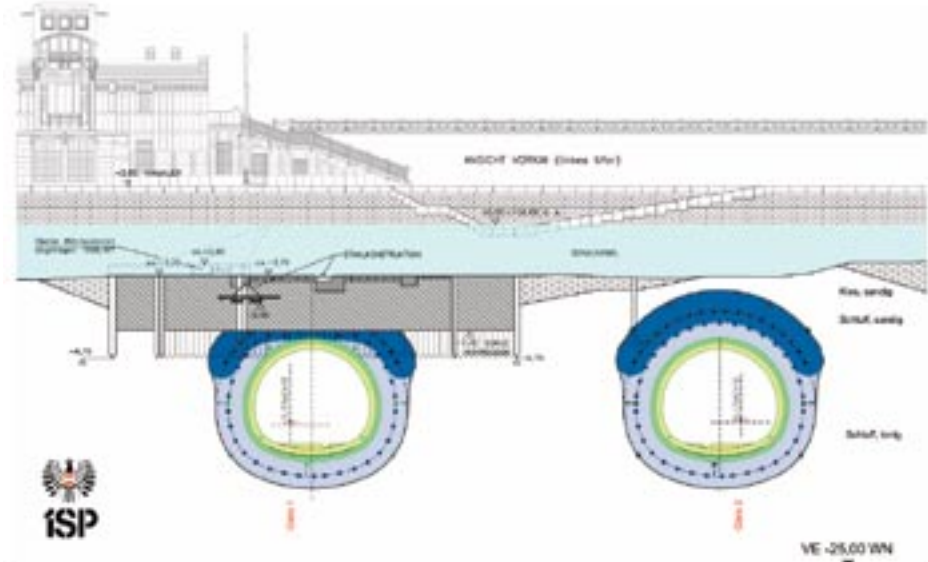

the longitudinal and transverse directions to allow the use of the New Austrian Tunneling Method; moreover, ground-freezing ensures the safety of the secondary lining from uplift forces. This means that the freezing has to be maintained until the primary lining is installed.

#### Liquid nitrogen freezing method.

We use a combination of the two freezing methods. Liquid nitrogen is used in the roof. This is a diagrammatic drawing showing how the cooling energy of liquid nitrogen with a temperature of  $-196$  degrees Celsius is introduced into the ground.

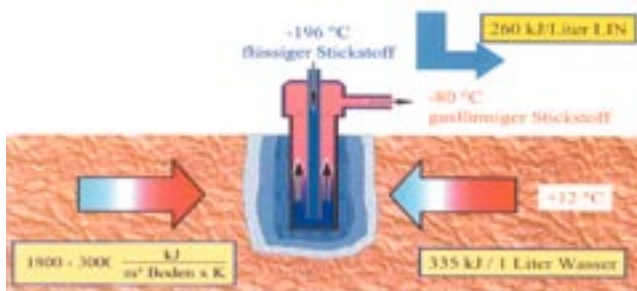

Nitrogen freezing viewed from the portal wall of the tunnel.



**Calcium chloride brine freezing**

Brine of calcium chloride is used for freezing the ground around the whole excavation cross-section. The freezing cycle with a freezing station works like a refrigerator.

The next picture shows the tunnel portal with brine freezing only. The refrigerating agent has a temperature of -35 degrees and, therefore, shows little visible ice.

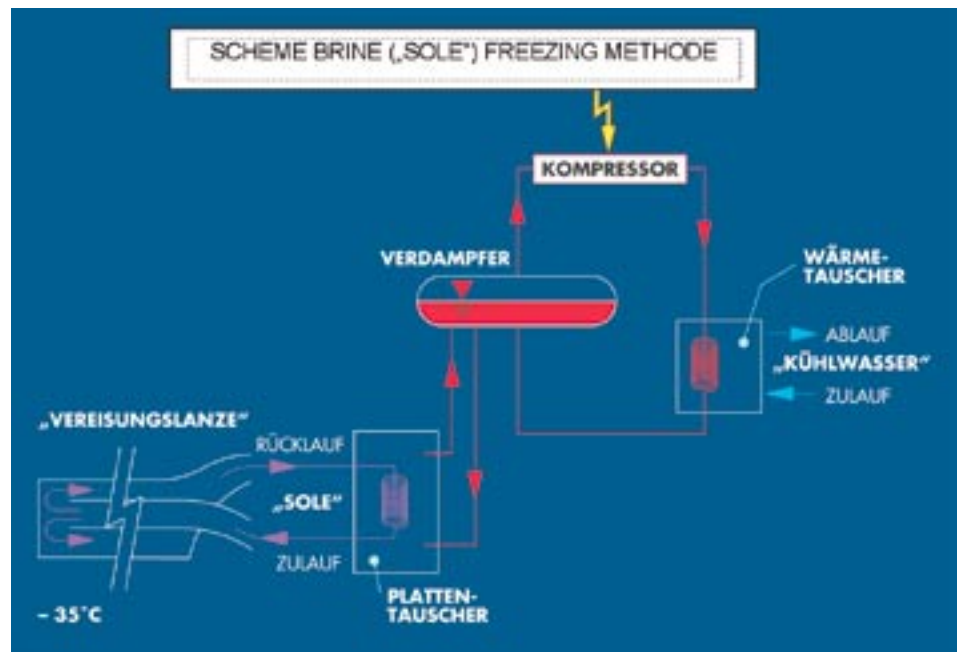

Tunnel with brine freezing methode



The drilling of freezing holes is under way at present. At the beginning of next year, we will start the freezing phase. The freezing volume is 14,000m<sup>3</sup>, and the freezing period will be about 10 months.

Work is advancing speedily because there is an absolutely final completion date – the 2008 European Soccer Championship!

## Technological Procedure of Construction for the Sitina Tunnel

---

Eng. Vladimír Kotrík,  
Banské stavby, a.s., Košovská cesta 16, 971 74 Prievidza, Slovak Republic;  
tel. +421 46 5190 111; fax +421 46 5424 494; email: vkotrik@nexta.sk

Eng. Anton Sumerák jr.,  
Banské stavby, a.s., Košovská cesta 16, 971 74 Prievidza, Slovak Republic;  
tel. +421 46 5190 111; fax +421 46 5424 494; email: asumerak@nexta.sk

Eng. Anton Petko,  
Banské stavby, a.s., Košovská cesta 16, 971 74 Prievidza, Slovak Republic;  
tel. +421 46 5190 111; fax +421 46 5424 494; email: petko@bespa.sk

### Abstract

Building section of the Motorway D2 Bratislava Lamačská cesta – Staré Grunty that has been commenced in year 2003 will form the last missing part of the motorway from the Czech Republic via Bratislava to Hungary. The twin tube tunnel Sitina is a dominant object of the construction.

The article describes technology and experience of BANSKÉ STAVBY, a.s. Prievidza during this tunnel Sitina construction. The construction is followed by experts especially by reason of driving in low overburden in heavy broken granitoid rock. By reason of that it will be necessary to use various forms of stability stope assurance.

### 1. Introduction

Twin tube tunnel Sitina is a part of motorway section D2 Lamačská cesta – Staré Grunty and it is first motorway tunnel in Slovak Republic built in town residential area of the capital city Bratislava. Total capital costs of the whole construction are more than 3,5 milliard Slovak crowns (Sk). 82% from this sum were provided in the form of an intergovernmental loan from a Japanese bank for international cooperation (JBIC). Other costs are guaranteed by national budget of Slovak Republic.

#### Main partners of the construction are:

- Client of the construction: Slovenská správa ciest
- Project engineer: Dopravoprojekt a.s., Bratislava, (Infraprojekt s.r.o. pre tunelové stavby)
- Main Contractor: Joint Venture Taisei – Skanska
- Subcontractor: Banské stavby a.s. Prievidza

### 2. Basic Technical Data

The tunnel Sitina consists of 2 tunnel tubes with one-way communication because view traffic loading rises according to transportation-engineering documentation by value of 20.000 vehicles per 24 hours in both directions already in year of introduction into operation.

The basic tunnel parameters are following:

- Traffic space: 7,5 x 4,8 m
- Area of stope: 79 – 98 m<sup>2</sup>
- Length of the tunnel: 1.415 m west tunnel tube (length of driven part is 1.189 m)  
1.440 m east tunnel tube (length of driven part is 1.159 m)
- Emergency bay: 1 bay of length 40 m in each tunnel tube
- Cross connections: 4 for persons, 1 for transit of emergency services
- SOS niches: every 150 m
- Fire niche: every 90 m
- Ventilation: longitudinal

Works on the Sitina tunnel construction have been commenced in September 2003. The construction is in progress from the both portals. The tunnel completion is planned in second half of year 2005.

### 3. Engineering-geological and Hydrogeological Conditions

The driving of the Sitina tunnel is situated in crystalline rock of Male Karpaty mountains. Mostly the massif consists of biotite and double-mica granodiorites, sporadically granites, often with veins or pegmatites to depth of 1,5m. Locally coarse blocks of schist – biotite paragneiss with thickness of several tens of meters locked tectonically in granitodiorites occur. Mostly the rocks are metamorphosed lightly but near by larger tectonic zones the rocks are heavy metamorphosed, locally mylonitized intensively. Mylonitization mainly affects schist, granodiorites are mylonitized exceptionally. The massif is intensively tectonic disrupted. Systems of cracks and breaks have a general direction NE – SW, E – W, locally N – S with a propensity to SE. The thickness of the cracks is 1 mm – 3 cm. At the main tectonic zones the thickness is within several meters. Most part of the cracks is filled with a clay material, less with tectonic breccia or mylonit. The above mentioned systems of discontinuities cause strong rock splitting what results in a large blocks. Rock blocks mainly have an oblique to polyedric shape with volume of several cm<sup>3</sup> up to 1 m<sup>3</sup>. At tectonic lines crossing – especially in granodiorites, in heavily split massif a falling out of rock blocks from face or top of the stope occurs often. The rock massif is dry. Only low groundwater flows relative to more intense rainfall activity were observed.

Fig. No. 1 Split rock and its blocks

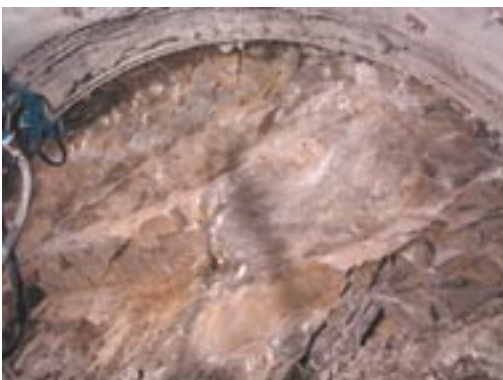

On the basis of a geological survey of the Sitina tunnel rocks of crystalline (granites, granodiorites, pegmatites), sporadically with thick tectonic zones were expected in the massif. The above mentioned expectations were confirmed but compared with the survey mostly schistes were found in the tunnel. In the present tunnel construction also tectonic zones occur more often than it was expected in prospecting project.

### 4. Technology and Process of Driving

The tunnel driving is executed by NATM. Five basic rock classes are designed (table No. 1) and to them single types of rock surroundings are assigned in accordance with ONORM B2203.

The tunnel stope in a cross-section is divided into a calotte, bench and invert arch in classes V and IV or into a calotte and bench in classes I – III.

With regard to heterogeneous rock surroundings and used supporting in single classes the construction technology is changed in some operations of the driving cycle.

Reinforcing class		I.	II.	III.	IV.	Va.	Vb.
Section length (m)	VTR	200	270	436	129	54	70
	ZTR	230	270	436	129	54	70
Step length (m)		2,5	2,0	1,5	1,0	0,8	0,8
Excavated area (m <sup>2</sup> )	topheading	48,64	49,52	50,40	50,40	51,31 - 57,87	51,31 - 57,87
	bench	30,45	30,73	29,67	29,67	30,01 - 30,90	30,01 - 30,90
	invert				12,32	12,89	12,89
	total	79,09	80,25	80,07	92,39	94,21 - 101,66	94,21 - 101,66
Loosing of rock		drill & blast	drill & blast	drill & blast	mechanical	mechanical	mechanical
Face segmentation	topheading	•	•	•	•	•	•
	bench	•	•	•	•	•	•
	invert				•	•	•
Shotcrete thickness (mm)	breakup	100	200	200	200	250	250
	face			50	100	100	100
	invert				200	250	250
Welded mesh	1. Layer	150x150x6.0	150x150x5.5	150x150x6.0	150x150x6.0	100x100x6.0	100x100x6.0
	2. Layer			150x150x6.0	150x150x6.0	100x100x6.0	100x100x6.0
Latticed arcuses			Arcus I	Arcus III	Arcus III	Arcus VIII	Arcus VIII
Anchors SN Ø29 (ks/bm)	l = 4m	3,75	2	2	3	7,67	7,67
	l = 6m		3,25	5	7,5		
Forepiles Ø25 (ks/bm)	l = 4m			10	15		
Micropiles Ø114 (ks/bm)	l = 12m					3,59	4,53

Tab. No.1 Parameters of single rock classes

#### 1.1. Rock Disintegration

For the disintegration two basic technologies of the rock disintegration are used:

- mechanized – classes IV and V.
- drill-blasting works – classes I to III.

Also a combination of the above mentioned methods is often used.

**Mechanized disintegration** is used in rock of a low strength. Tunnel excavator Liebherr 932 or 934 equipped with grab shovels and additional devices (rock cutter, hydraulic impactor) are used.

**Drill-blasting disintegration** is used in rock or half-rock ground. Drilling works are executed by a drilling jumbo ATLAS COPCO ROCKET BOOMER 352. For the blasting works plastic explosives Danubit 2, Danubit BMV, Danubit E are used. Nowadays an electric initiation is used. Using of a nonelectric initiation is planned. Effects of the

blasting works are measured continually and their parameters are modified in such way so that no undesirable effects occur.

### 1.2. Loading and Haulage

For the loading wheel loaders CAT 966, KOMATSU WA 270 or LIEBHERR 914 excavator (invert arch) are used. For the haulage dumpers KOMATSU HA250 and VOLVO A25D are used.

### 1.3. Supporting - Primary Lining

Immediately after termination of the stope primary lining is realized. The primary lining is created by combination of shotcrete, lattice girders, mesh and bolts. Particular elements quantities (and primary lining parameters connected with this) are stated in chart No. 1.

Shotcrete which is used for the construction is B-30 and it is applied by wet way using a non-alkaline accelerator. Spraying machines MEYCO POTENZA with manipulator is used for application. Dry spraying system serves like a reserve.

Meshes and lattice girders that improve strength shotcrete properties are built in from working platforms LIEBHERR 912 or MANITOU.

Bolds SN 28 of 4-6 m length provide for synergism of support with rock surroundings.

### 1.4. Secure of Stope in Advance

It is used in rock class (RC) V and VI eventually RC 3. Forepole rods  $\varnothing$  25 mm, 4,0 m length, protective micropiles umbrella  $\varnothing$  114 mm of length 12,0 m are used.



Fig. No. 2 Drilling of the micropiles umbrella

**Protective rod umbrella** is used in RC III and IV. In dependence on rock massif quality various number of forepole rods are used, maximum 40 pcs / step.

**Protective micropiles umbrella** is used in portal sections and crossing failure zones in very bad geological conditions. Micropiles are composed of casing string  $\varnothing$  114 mm. After casing string retraction borehole is filled in with cementing mixture. Drilling of the borehole is realized by drilling jumbo Atlas Copco that is equipped by BOODEX system which enables drilling simultaneously with casing string retraction.

#### 5. Progress of Construction and Ventilation System

Considering the short construction period it is necessary to execute works on the tunnel construction simultaneously (excavation and concreting of secondary lining) to a maximum extent. This puts intensified claims on construction organization. Ventilation system and traffic organization in tunnel tubes (picture No. 3) have been adapted to the actual construction of the primary and secondary lining.

System, which is applied, basically will enable separation of the driving works from the secondary lining construction works. Effective implementation of this system has required enlargement of escape corridor profile (escape corridor No. 5 and No. 3) to through profile size.

Nowadays 620 m in the west tube, 520 m in the east tube of the south portal and 120 m in the west tube and 45 m in the east tube of the north portal are driven.

Fig. No.3 Scheme of the ventilation of the Sitina tunnel

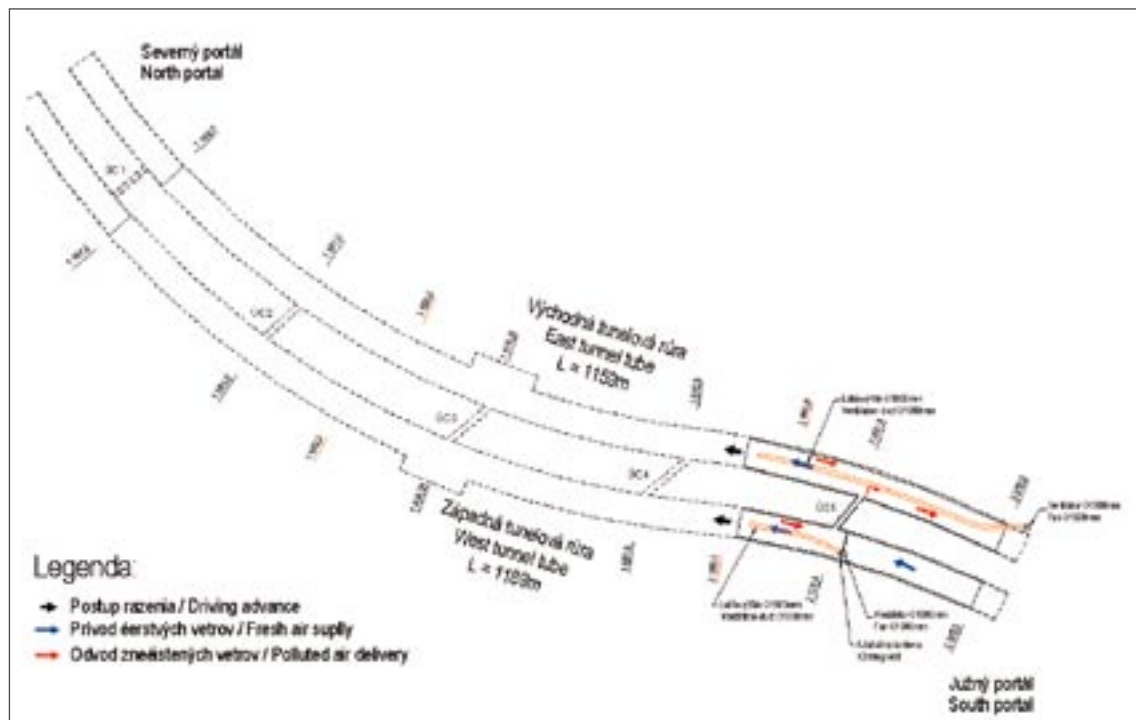

#### 6. Influence of Municipal Tunnel Construction on Environment

As above mentioned the Sitina tunnel is situated in residential area of the capital city Bratislava. Apart from positive influences after the tunnel actuation (in comparison with present state of transport) the tunnel also has negative influences on surroundings.

The most substantial influences are the following:

- Stability of the tunnel and its overburden
- seismic effects of the blasting works
- noisiness during the construction
- others common environmental risks (dust, oil matters, pollution of underground water and bell jar, etc.)



### 6.1. Stability of the Tunnel and its Overburden

In residential areas with a low overburden where no assumption of a natural rock arch creating is there is a big danger of effects of settlement on the surface up to break with consecutive overburden collapse (destruction of public services, buildings and other constructions).

From this reason it is necessary to monitor in detail and to eliminate by suitable technological and project measures the following aspects:

- settlement of the tunnel roof and on surface too
- convergences
- to secure stability of the face by suitable measures

### 6.2. Seismic Effect of the Blasting Works

Seismic monitoring consists of the following steps.

- classification of endangered buildings in mentioned area
- execution of test blast so that to define seismic rock facilities
- installation of seismographs for monitoring of elastic velocity of vibrations at assigned places near the tunnel. Relocation of seismographs is according to the driving process.
- continual evaluation of measurements and adjustment of the blasting works to minimize the influence and to stop the damage of adjacent objects.

The Sitina tunnel is situated near by the Slovak Academy of Sciences where various sensitive instruments are used. Also the ZOO and riding school are situated 20 meters above the tunnel.

### 3.3. Noisiness During the Construction

The noisiness monitoring consists of the following steps:

- classification of the most sensitive parts of the surroundings
- to define maximum admissible values for the day time (6:00 to 22:00) and the night time (22:00 to 6:00). Reference of the measurements quantity is equivalent to the noise level. Government Order of Slovak Republic No. 40/2002 about health protection against noise and vibrations specifies the highest admissible values of the noise for an outer space (applicable in the Sitina tunnel)
- evaluation of noise level
- project of antinoise measurements
- measuring of noise level at exposed places in surroundings
- valuation of the measurements
- antinoise measures

## 7. Conclusion

The Sitina tunnel is first tunnel construction in Slovakia realized as an international project where high work quality and engineering relative to FIDIC demands are required. Also a big accent is put on public relations and on relation with the customer. For our company it is a big challenge, experience and possibility too to demonstrate our large skills from the tunnel projects realized in West Europe.

## Koraln tunnel - Benefits of a structured design and investigation process – the client's view

Mag. Gerhard Harer  
Project Manager

HL-AG  
Griesg. 11/II  
A-8020 Graz

Phone: #43 316 772930  
Fax: #43 316 772930-8  
E-mail : gerhard.harer@hl-  
ag.com

### Abstract

At present many European railway companies are working hard to create an efficient trans-European railway network. Austria defined, in conformity with European intentions, five main railway axes to be improved, one being the Pontebbana axis, connecting Eastern Europe via Vienna with Italy and the Mediterranean Sea. One of the key projects along this axis is the Koraln tunnel with a length of 32,8 km. From the very early stages of planning for the Koraln tunnel a strategy of a stepwise investigation has been executed. The profound knowledge of this stepwise investigation procedure was summarised in an expert system and formed the basis for route selection, environmental impact assessment and risk analysis. For specific sections of the tunnel additional investigation tunnels are currently carried out. Performing a way of a stepwise-improved knowledge enabled to save significantly time and money and though providing sufficient geological data for every project phase.

**Keywords:** Pontebbana, Koraln tunnel, Site investigation, Route selection, Risk assessment

### Introduction

Due to Austria's location in the centre of Europe, within the Alps, Austria has played an important role for European passenger and goods traffic since historic times. Crossing the Alps has historically been one of the biggest challenges in the construction and maintenance of traffic routes. The construction of tunnels was one of the solutions to deal with the topographical problems.

The construction of extensive railway routes during the last decades of the Austrian – Hungarian Monarchy in particular and the major motorway projects in the sixties, seventies and eighties of the 20<sup>th</sup> century resulted in more than 300 road tunnels and around one hundred km of railway tunnels in Austria.

#### The Austrian High Capacity Railway network

Ever since Austria became a member of the European Community, Austria have had to deal with an enormous increase in traffic. Also for the future, in particular because of the entry of several southeastern European countries to the EC in May, 2004, a significant traffic increase, with an above-average increase of road transport, is predicted.

However, the changed political and environmental situation in Europe in the future will require a transport system that is suited to the dimensions of the European Continent. Most notably the high speed travelling by rail is an environmentally compatible solution whilst at the same time enabling long-term sustainable mobility.

Many European railway companies are currently working hard to create an efficient trans-European railway network, in parts as a reconstruction of former existing railway communications. In this task, they are receiving political support at both national and international level.

Austria's government defined, in conformity with European intentions, five main railway axes to be improved:

- the Danube axis from Eastern Europe via Vienna to Salzburg and Germany
- the Pontebbana axis from Eastern Europe via Vienna to Italy and the Mediterranean Sea
- the Pyhrn axis from Germany via the central regions of Austria to Slovenia
- the Tauern axis from Germany via Salzburg to Italy and Slovenia
- and the Brenner axis from Germany to Italy as well as Switzerland

Investments of almost 30 billion Euro in total, about 1,4 billion Euro the year, are foreseen for the future improvement of Austria's railway infrastructure within the next decades. Meanwhile in Austria around 200 km of new railway tunnels are being planned or are under construction, some are actually in operation.

Considering already the number and the extension of the projects, in particular of future subsurface structures, special efforts have to be undertaken to guarantee an efficient process to keep time and cost estimated. Some aspects of a structured design and investigation process of the Koralm tunnel will be presented below.

### Koralm tunnel

One of the key railway connecting lines in the Trans European Network (TEN) is the so-called Pontebbana corridor. It represents the easternmost crossing of the Alps and links eastern Europe, Vienna, southern Austria and northern Italy (see figure 1).

Fig. 1: The Pontebbana axis (overview)



and links eastern Europe, Vienna, southern Austria and northern Italy (see figure 1). Main efforts to improve this connection were implemented in several stretches along the line. One of these projects is the Koralm railway in the South of Austria. This new stretch will have a total length of approximately 130 km, and will underpass the Koralmpe, a mountain range between the provinces of Carinthia and Styria. It will decrease the travel time between the provincial capitals of Graz and Klagenfurt from the present time of three hours to one hour [1]. The most prominent tunnel along this stretch will be the Koralm tunnel. This double tube tunnel will have a length of approximately 32,8 km, making it Austria's longest tunnel and the seventh longest tunnel project in the world [2]. The maximum overburden will reach almost 1.200 m.

#### Geological outline

The mountain range, which will be crossed by the Koralm tunnel, consists of a polymetamorphic crystalline basement. Predominant lithology consists of mylonitic gneisses and micaschists, with occasional marbles, amphibolites and eclogites. The crystalline basement is bounded by master faults, which have generated tertiary basins on both sides of the mountain range. These occur as the Weststeirische Becken in the East, and the Lavantaler Becken in the West. The sediments of both Tertiary basins encountered by the tunnel are mainly clastic deposits of fluvial and marine origin (see figure 2).

The recent morphological features of the Koralm massif were formed by Tertiary to Quaternary brittle faulting, weathering and erosion. Residual soils, generated by deep reaching in situ weathering and periglacial debris, cover the bedrock.

Fig. 2: Geological overview of the Koralm tunnel

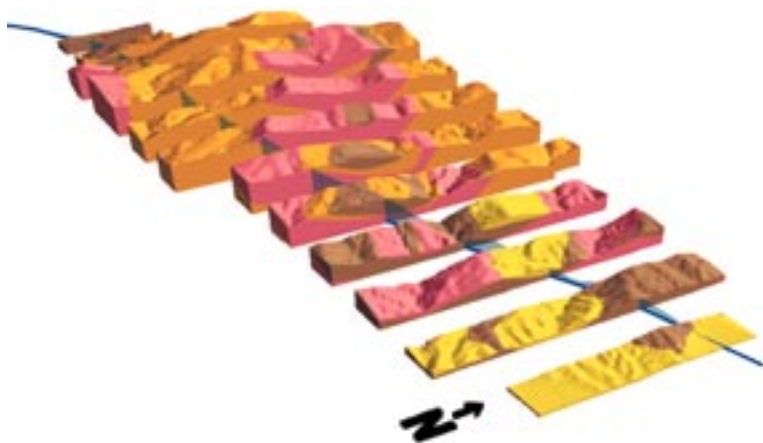

#### Project status

HL-AG was authorised by the Austrian government in 1995 to undertake the planning and the design of the Koralm railway including the Koralm tunnel. Meanwhile the route assessment, the tunnel system decision and the environmental impact assessment could be concluded. In a next step further investigation measures as basis for the detailed and tender design are carried out. For that purpose in the past years a series of deep drillings, reaching depths of 1.160m, were performed successfully. Last year the construction of a system of investigation shafts and tunnels with an estimated length of 11 km, as schematically shown in the figure 3, was started. Depending on the results of the detailed investigation and design as well as the processing by the authorities the construction works for the Koralm tunnel could start in the year 2008/2009.

Fig. 3: Investigation tunnel concept for the Koralm tunnel

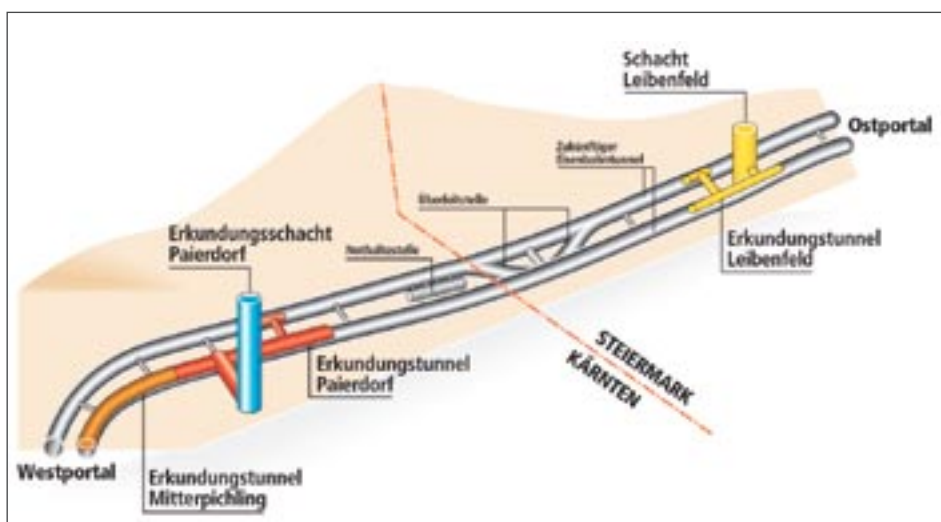

### Site Investigation for the Koralm tunnel

The basic target of site investigations shall be a detailed characterisation of the rock mass. Contrary to investigations for many tunnel projects, which are usually performed according to general guidelines, site investigations for the Koralm tunnel were specifically carried out according to the type of rock mass and the phase of the project [3]. Specific rock mass related criteria form the basis for rock mass models, generated out of a consistent three-dimensional geological model.

The criteria are defined by lithology and discontinuity structure. They also include the influencing factors in situ and secondary stresses, as well as groundwater. The parameters, which constitute rock mass models, are those, which are relevant for the rock mass behaviour during construction, taking into consideration support requirements and the excavation sequence.

With the objective of cost optimisation in mind, the rock mass model, achieved by site investigations is improved stepwise during the different planning phases.

During the phase of route pre-selection (phase 1) the relevant input data based on desk studies and geological mapping of selected areas. At the stage of route selection and environmental impact assessment (phase 2) the geological field work was extended and supplemented by subsurface investigations consisting of core drilling, well log and in situ measurements and geophysical survey. Several improved or new investigation and determination methods [4] were used and led to an excellent, and hopefully realistic, knowledge of the ground conditions (see figure 2). This formed the basis and supplied the key input data for environmental impact assessment, the assessment for further investigation requirement for the detailed design and tender phase (phase 3) as well as for the risk analysis.

The knowledge of this stepwise investigation procedure is summarised in Geographical Information System (GIS).

### Route selection

The objective of the first investigation campaign was an engineering geological assessment for a TBM excavation. General investigation targets were the

- bedrock condition (lithologic variations, material properties, permeability, weathering, etc.)
- discontinuities (orientation, spacing, persistency, surface properties and infillings)
- assessment of groundwater conditions
- as well as the identification and characterisation of fault zones by morphological and structural appearances.

Based on the results of the geological mapping the rock mass was classified and a preliminary geotechnical model was developed. Core drillings and geophysical surveys at selected locations with specific geotechnical targets were used to verify that model and to establish a spatial model for each investigation area. Together with the findings of the previous site investigation the “gaps” between the investigation areas were filled and a three-dimensional geotechnical model for the entire route corridor was developed [5, 6, 7].

Since the portal areas are dominated by environmental considerations and alignment requirements, and only to a limited extent by geotechnical factors, a mostly

geotechnically influenced route selection was performed mainly for the crystalline central part of the Koralm tunnel.

The availability of data in the form of a GIS - database allowed a new approach for the ranking of alignment options in the central part.

Out of numerous data sets

- expected radial deformations
- number and length of defined faults
- net drilling rate
- water conditions

were considered to represent the conditions relevant for tunnelling with respect to cost, time and risk.

Spatial information was transformed to a horizontal plane at tunnel level by using the GIS, which represents a generalised model of the ground conditions as a set of map layers and their relationships.

To estimate construction time and costs for different routes the GIS-based system provided a tool, with which the civil engineer was able to select different routes. So the decisions were not mainly based on qualitative assessments but also supported by tangible figures.

The way of defining or refining an alignment by introducing spatial information at the tunnel level in GIS format appeared to be very suitable. It allowed a tunnel alignment to be defined by its major factors – tunnelling conditions expressed in cost and time – and not only by civil engineering or qualitative criteria. However, sufficient and relevant information has to be available at early project stages. Also, sufficient time for planning has to be scheduled to assess all criteria properly.

#### Risk induced assessment for cost estimates

In order to achieve economic success for a major infrastructure project like the Koralm Tunnel, difficult decisions based on a wealth of alternatives and unknowns are already required at an early project stage. The GIS-supported geological and geotechnical data also provided important input data for the risk assessments.

One major task in the course of the ongoing design process is the preparation of cost estimates. Considering a great number of risks and uncertainties, variation in cost could be determined in a realistic way to evaluate the risk associated with financing the project; the existence of a consistent geological model provided the basis for geological and geotechnical input needed (see figure 4).

Fig. 4: Histogram for construction costs

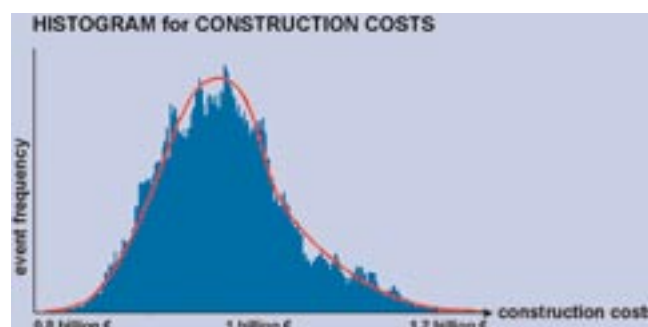

### Assessment for further investigation requirements

Fig. 5: Fault bounded Tertiary basin of the Lavant valley (schematic sketch of bedrock surface)

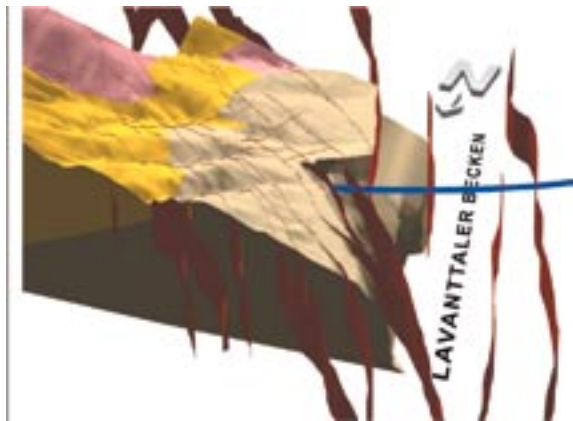

The existing geological and geotechnical knowledge enabled to work out specific sections with higher geological risk, with special respect to the intended performance of TBM's for the main tunnel tubes excavation [8]. As stated above the crystalline basement is bounded by master, extensive fault zones, which have generated tertiary basins on both sides of the mountain range, as schematically shown in figure 5.

Predominant subsoil and groundwater conditions in these portions (e.g. >120 m water table above tunnel level in loose Tertiary sediments or fault gauges with thickness of several meters in crystalline rocks) might lethally influence TBM-tunnelling if not known in detail and eventually improved in advance of main tunnel excavation.

However, only for specific sections of the tunnel (about 1/3 of the tunnel, see also figure 3) this additional investigation by means of investigation tunnels is necessary for detailed and tender design. So the application of these time consuming constructions can be reduced to its minimum.

### Conclusion

The portion of investigation with respect of the budget of time and costs must not be neglected. Therefore from the very early stages of planning for the Koralm tunnel a strategy of a stepwise investigation has been executed. The profound knowledge of this stepwise investigation procedure was summarised in an expert system by means of GIS and formed the basis for route selection, environmental impact assessment and risk analysis. For specific sections of the tunnel additional exploration by means of investigation tunnels was found necessary for detailed and tender design.

Performing this way of stepwise-improved knowledge enabled to save significantly time and money and though providing sufficient geological data for every project phase.

### Reference

1. Vavrovsky, G.M, Schneider, K., Harer, G.: Koralm-bahn – A new Railway Line in the South of Austria.- Felsbau 19 (2001), No. 6, pp. 8-12
2. <http://home.no.net/lotsberg/>
3. Harer, G., Riedmüller, G.: Assessment of Ground Conditions for the Koralm Tunnel during the Early Stages of Planning.- Felsbau 17 (1999), No. 5, pp. 374-380.
4. Dörrer, Th. et al.: Combined Application of Geophysical Measurements; Case History Koralm Tunnel.-Felsbau 18 (2000), No. 5, pp. 37-47.
5. Goricki, A., Schubert, W., Steidl, A., Fuchs, R.: Geotechnical assessment of the route corridor.- ISRM Reg.Symp. Eurock 2001, Espoo, Finland
6. Steidl, A., Goricki, A., Schubert, W., Riedmüller, G.: Geological and Geotechnical Ground Characterisation for the Koralm Route Selection.- Felsbau 19 (2001), No. 6, pp 14-21
7. Mussger, K., Harer, G., Koinig, J.: Koralm Tunnel – An Innovative Approach to Alignment Selection.- Felsbau 19 (2001), No. 6, pp42-47
8. Burger, D., Lauffer-Neumann, D., Mussger, K.: Risikoinduzierte Bewertung von Tunnelvortrieben.- Felsbau 20 (2002), No. 5, pp65-72

## “Parcheggio San Giusto”, Underground Parking Caverns in the Heart of the Old Town Centre of Trieste, Italy

Dott. Franco Sergas\*, Ing. Tommaso Tassi\*\*, Dott. Johannes Kleberger\*\*\*

\* Mecasol S.r.l. via dei Cosulich 8 Trieste – Italy  
tel. ++39 040 827789, fax. ++39 040 830018, email: mecasol@adriacom.it

\*\* Favero & Milan ingegneria S.r.l. via Varotara 57 Zianigo Mirano (VE) – Italy  
tel. ++39 041 5785711, fax. ++39 041 4355933, email: ttassi@favero-milan.com ,  
www.favero-milan.com

\*\*\* iC consulenten zT GmbH , Zollhausweg 1 A-5101 Salzburg/Bergheim,  
+43 662 450 773, email: j.kleberger@ic-salzburg.at, www.ic-group.org

### Abstract

The paper illustrates the proposal for the realization of a multilevel underground parking under S.Giusto hill for 724 cars in the old town centre of Trieste, to be realized through Project financing. The parking consists in two caverns on five levels, sized 17x120x18 m, with cover varying from 20 to 40 m and noteworthy problems as regards fire-fighting rules and regulations, particularly ventilation. Since natural ventilation, as requested by laws in force, is not exploitable in this case, the project considers the use of completely mechanical ventilation. This proposal has obtained the approval of Trieste Firemen Authority.

**KEYWORDS:** Underground parking, cavern, project financing, ventilation.

### Introduction

The town of Trieste suffers from a serious lack of structures for parking. This deficiency is particularly serious in the old town centre for its concentration of productive, commercial and service activities, and for the renewed interest in residential use. The need to realize a parking in the area has been highlighted by the ongoing intervention for the reclamation of the most ancient part of the “Cittavecchia”, financed with “Programma Urban” European fund. In order to solve the strong deficiencies of structures for parking in the area bordered by Rive – Via Canal Piccolo – Corso Italia – Via del Teatro Romano – Via del Mercato Vecchio and Via San Rocco, in 1996 the Municipality of Trieste has selected the area of S. Giusto hill as a possible location for the realization of the parking. Subsequently to the approval, in 1999, of Regional Law 20 on Project Financing, the Municipality inserted the project in the Triennial Plan of Works of Public Interest, with the intention to verify the interest of “private promoters” in the realization of the work. On June 30th 2000 the proposal of an underground parking in caverns for 724 cars stands was presented by a group of promoters. At the moment the project is under evaluation by the authorities; most probably by the end of this year the Municipality will formally entrust the realization of the work.

More than four years have passed since the submission of the project: an extremely long period of time. This has been determined by a series of reasons: first of all, the laws and regulations on this subject are very recent; as a second thing, it



is one of the first project financing procedures to be attempted in Italy. A number of complex evaluative issues and doubts on procedures have arisen and have required a much longer time to be solved than expected. The Municipality of Trieste will transfer to the Concessionaire the 30-year building right, and the right to exploit and manage the parking of 384 car stands and to sale to a third party the 90-year building right for the remaining 340 car stands.

### **Project Financing [1],[2]**

Project financing, that is - using the expression employed by the legislator - the realization of public works without financial charges for Public Municipalities, constitutes a model for the financing and the realization of public works. For a long time in use in the Common Law countries, Project financing is, first of all, a complex economic-financial procedure which turns to a specific investment for the realization of a work and/or the management of a service, promoted by private or public sponsors. The most authoritative specialists of this topic tend to define Project financing as a financing process of a particular economic unit, in which a financier is satisfied to consider, from the early stages, the cash flow and the profits of the economic unit under discussion like the source of funds that will allow the refunding of the loan, and the activities of the economic unit like a collateral guarantee of the loan. The noteworthy economic aspects of a project financing process are:

- self-liquidation, that is the ability of the project to produce a cash flow sufficient to cover the operational costs, to pay back the financiers and to assure a profit to the promoter of the operation.
- the concentration of the financing in an independent centre of legal and financial reference (Special Purpose Vehicle: frequently a planning company), to which the financial means and the realization of the project are entrusted, with consequent legal and financial separation (ring fence) between project and sponsors; as a result project financing is placed in an off-balance position (off-balance sheet financing) in comparison with the other activities of the promoters or shareholders of the planning company;
- the creation of “indirect guarantees” in favour of external financiers, based on a wide range of agreements between the parties interested in the project, founded on the feasibility studies of the project, on the economic-financial plan with the related realization flows, and on risk analyses; the possibility of compensation for the financiers and the other creditors (contracts of works, supplies, etc.) towards sponsors keeps limited to the value of financial activities.

All Project Financing processes are characterized by high risk and, for this reason, it extremely important to detect all the risks that the construction and management of complex works can rise; the possibility to subdivide, through a well-organized negotiation process, all those risks among the various participants in the operation must be attentively considered since it can be very important in the financing stage. So all the risks of the operation must be rigorously assessed and evaluated:

- design stage risks, particularly for construction and approval timing;
- construction stage risks, concerning the feasibility of the work as previously planned;
- management stage risks, particularly for the planning of the activity which has to

guarantee the recovery of the first investment.

Every assessment mistake can determine serious consequences from the economic point of view, and can alter the financial equilibrium which represents the main premise for the involvement of the promoter.

In the case under discussion that financial equilibrium can be reached by means of a total investment of € 24.332.000, while the construction cost is € 21.012.000. That amount can seem high, but it must be considered that the structure is totally hidden under S. Giusto hill. The high cost wouldn't allow to obtain the financial equilibrium if per-hour fees higher than the standard mean parking fees were not imposed; so it has been asked the Municipality – who accepted – to offer a public share of € 8.367.000. Laws in force provide for that possibility in case the financial equilibrium can't be reached through the parking fees.

The duration of the building permit is established in 30 years, - 3 years for construction and 27 years of management: this period of time seems to be long enough to recover the invested amount. Financial Plan establishes that economic equilibrium will be reached after 6 year, and it will maintained up to the 30th year. The settlement of the debts for the realization of the structure has been placed in the 17th year. Net estate dynamics show a gradual decreasing of the initial amount for the work starting-up, followed by an increase stage up to the complete recovery of initial losses in the 12th year and, starting from the 15th year, the collection of profits. The cost/profit percentage shows a yield index (I.R.R.) of 11%, an extremely positive rate in comparison with works with the same characteristics.

#### Description of the Urban Area

The area object of the study is placed in Trieste town centre, in correspondence with Colle S. Giusto, bordered by via del Collegio, androna San Saverio, via delle Monache, piazza San Cipriano and via della Cattedrale.

The location of the parking is strategic from the point of view of the users, both residents and occasional, since it is adjacent to urban hyper-centre areas. Rive, which

constitutes the main urban axis, gives access to the parking through an internal road system consisting in Via Mercato Vecchio, Via Punta del Forno and Via Teatro Romano (which represents both the entrance and the exit of the complex). The exit-flux flows into Corso Italia, through which it is possible to reach different destinations and to return to the axis of Rive.

The particular urban lay-out of that area makes difficult the arrangement of the building yard and the transportation of excavated material. For these reasons, technical-operational feasibility studies have been carried out in order to avoid interferences with the urban traffic.

The aerial photo below highlights the great complexity of the intervention in the selected area.

Figure 1 - aerial photo of S.Giusto hill with the indication of the project area.



**Geological Situation [3]**

Site investigation took advantage of previously available geological data and reports. For the particular project site continuous core drillings down to 50 m, including insitu and laboratory testing were carried out.

Rockmass consists of flysch formations, containing Eocene aged marls and sandstones. Sandstone layer thickness varies from few centimetres to one meter, the marls from few millimetres to 40-50 centimetres.

Figure 2 – geological-structural plan.



Figure 3 – geological section.

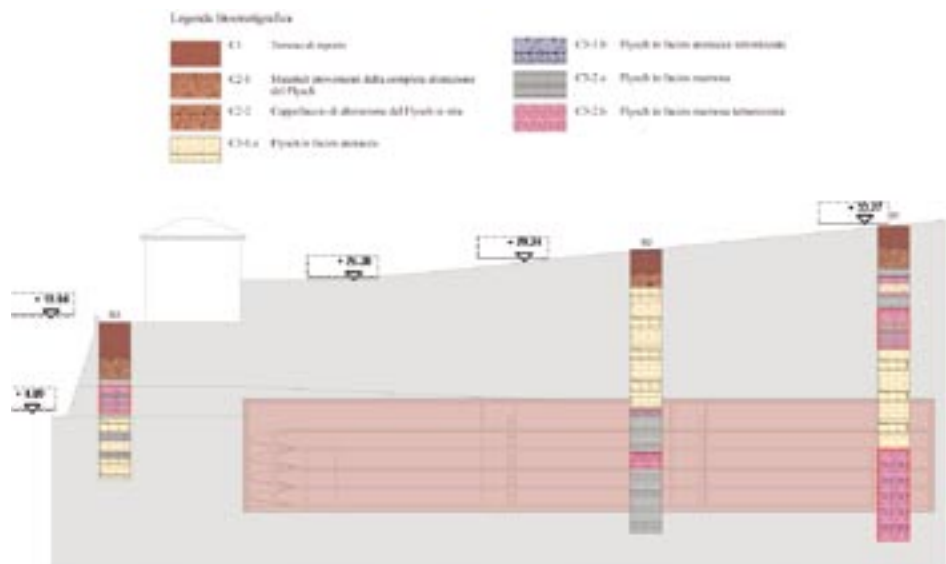

The main tectonic pattern in the area consists in a wide range synclinal fold (slightly bending) with axis NW- SE dinaric oriented, immersed along this axis, while the local lay-out of San Giusto hill presents a series of dinaric oriented vicarious faults. The faults are of particular significance for the engineering geological model.

The construction of the huge caverns below the shallow rock cover and beneath old houses for sure is challenging from point of rock mechanics.

### Description of the Parking Facility

The area which will be object of the recovery of Via Capitelli is placed in the north-western side of S.Giusto hill, with an elevation included between 1,6 m (Square Cavana) and 21,12 m (Square S. Silvestro).

The selected “volume” for the underground parking is placed below an area partially occupied by the “Seminario” (seminary) and the “Convitto delle Monache” (nuns’ boarding school) rising on the offshoots of S. Giusto hill.

The solution is represented by the realization of two caverns on five levels - size 17x120x 18 m - both connected through a single tunnel to via del Teatro Romano.

Inside the two caverns, two one-way ramps with inclination of 12.8% linked by one transept (double-way) connect the five levels for a total capacity of 724 car stands, with compartments of area 1.500 m<sup>2</sup> or less.

One of the five levels is placed at the same elevation as via del Teatro Romano, another one has an elevation of about 3 m above street level, while the remaining levels below street level.

There are two entrances for pedestrians. The main one, from via del Teatro Romano, follows a path, divided from that for vehicles, along the entry tunnel. The second access is placed on the backside and leads directly to the top of S. Giusto hill for a swift access to the archaeological site.

Figure 4 – preliminary design for the S.Giusto parking, axonometric view.

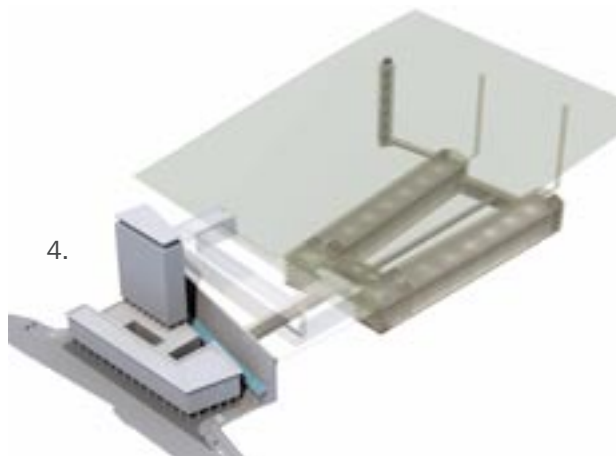

Figure 6 - preliminary design for the car park, general plan.

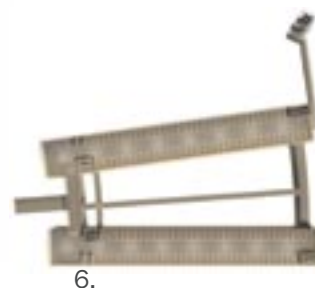
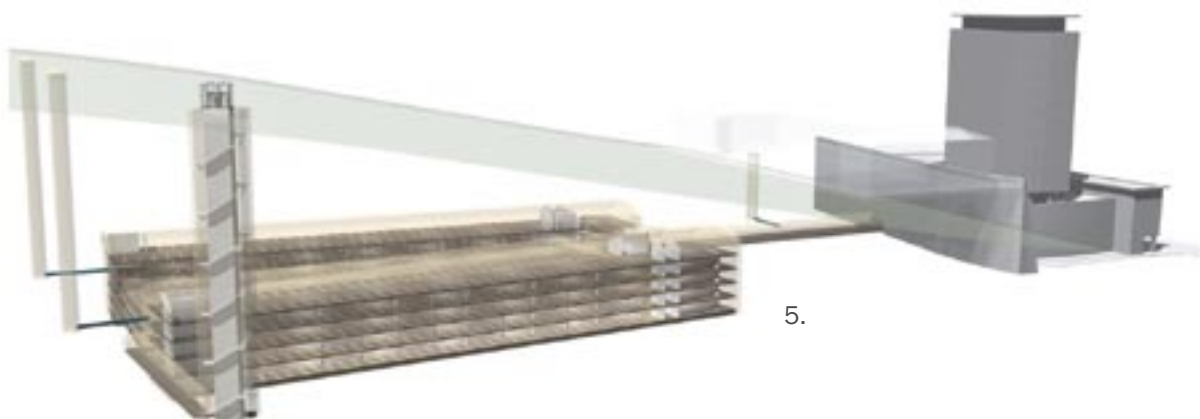

Figure 5 - preliminary design for the car park, perspective view.



### Fire Safety [4]

The following measures have been suggested for safety in case of fire:

- accidental events have been taken into consideration as regards defined areas of the garage, since a flashover stage extended to the whole system is prevented by numerous partition the numerous fire barriers;
- a fire-fighting surveillance system, managed by 24-hour specific personnel, has been considered;
- a single “control room”, external and isolated form the garage and a power system of for the feeding of technologic systems.

The design, particularly as regards smoke detection and the automatic activation of partitions, sprinkler system, emergency ventilation has been carried out taking into account the prevention and control of the critical event and offering, at the same time, the highest number of escape routes from the garage.

Two escape routes have been designed for each compartment, leading to a smoke-proof stair protected by smoke filters, in REI 120 structure, equipped with automatic-locking doors with constant over-pressure of at least 0,3 millibars maintained by a specific system; the overpressure intake system of will be fed by the standard urban power system and, through automatic switchover, by an emergency generator set, with automatic starting and insertion in case of drooping of the main feeder.

The escape routes along the stairs lead to a dynamic safe room placed in a pedestrian tunnel barycentric to the two caverns and connected to the entrance-exit tunnel for vehicles. That room has the following characteristics:

- forced air intake, through its service well with a diameter of 800 millimetres leading to Via delle Monache , also guaranteed in case of drooping of the main electrical feeder thanks to emergency generator sets, in order to obtain 3 volumetric air changes per hour.
- filtering of the accesses to such zone through the interposition of smoke-filtering REI 120 structure, equipped with emergency automatic-locking doors with constant over-pressure of at least 0,3 millibars, among the safe place, the stairs and other corridors;
- direct connection through smoke-proof crossing paths to the main entrances of the garage, oppositely positioned.

The particular positioning of the garage, realized into two volumes obtained from the rocky mass of San Giusto hill, actually determines the impossibility to obtain natural ventilation through ducts of total sections with surface equal to 1/25 of parking surface and 30% of aeration surface for ramps as requested by laws in force.

The main reason is represented by the positioning of the garage, placed 20-40m under the densely built-up ground surface. The only possible solution is forced ventilation by means of ventilation wells and the main opening, consisting in the entry tunnel. What follows have been considered as a solution:

- a ventilation well - diameter 2500 mm - for air extraction from each cavern;
- a ventilation well - diameter 800 mm - for aeration of ramps;
- a ventilation well - diameter 1500 mm - for forced air extraction from ramp area through entrance-exit tunnel.

The expected ventilations can be subdivided into three different situations.

#### Standard management

In case of standard management, when there are no obstacles against the flowing of the air from the entrance in Via del Teatro Romano to the ventilation pipes placed at the end of the compartments, two air changes are expected in the whole complex. The ventilation process will be carried out by means of:

- two axial helical fans with variable pitch in motion, with the following characteristics: rotor with wing-profile shovels with automatically variable angle-shot by means of servo control; three-phase explosion-proof engine, case with post-straightener wings; variable capacity with continuity from 72.000 to 140.000 mc/h and adequate head; those fans will be placed at the end of the entry tunnel, and they will have the same tunnel as source in order to create a depression at the entrance door and to produce a flow of fresh air;
- ten axial helical fans with variable capacity with continuity from 7.200 to 18.000 mc/h. These fans will be placed on the short wall at the bottom of the compartments, and will have, as source, the same compartments and, as throw, one of the two tail pipes - diameter 2500 millimetres - that lead to Saint Giusto hill.

#### Pollution emergency

If into a compartment the warning stage for the concentration of CO and Nox gases is overcome, all the connection doors keep open and the whole garage continues to be a single volume unit. Air continues freely flow from the entrance in Via del Teatro Romano to the ventilation ducts placed at the end of the compartments; ventilation guarantees five air changes for the polluted department (for a maximum of three compartments at the same time), while other compartments keep their two air changes per hour. The ventilation will be carried out by means of:

- two fans whose capacity will automatically be increased, beginning from 72,000 mc/h, according to the number of pollution warnings - one, two or three compartments;
- one to three fans for the compartments subject to pollution warning, whose capacity is increased to 18.000 mc/h, in order to realize five air changes per hour;
- seven to nine fans which go on supplying a capacity to guarantee two air changes per hour of standard management.

#### Fire alarm

##### 1<sup>st</sup> CASE

The fire warning takes place into a compartment; this event is detected both by smoke detectors, installed in all the areas of parking and passage, and by dispensers of the Sprinkler automatic fire-fighting system, which automatically start working in the involved area and, at the same time, activate the expected "fire warning" procedure. If that area is a parking zone, the connection to the ramps of the involved sector are closed through the automatic unhooking of the electromagnets which hold the fire barriers.

At the same time air extraction begins thanks to the fans placed at the bottom

of the same compartment, for a capacity of eight air changes per hour; immediately an automatic shutter is opened; in order to supply fresh air to the compartment now sealed and cut off the “washing” standard management ventilation, that shutter directly links the compartment to a duct which adducts fresh air coming from the entrance for vehicles of via del Teatro Romano and passes through the false ceiling of the tunnel entrance (class REI 180 false ceiling).

Such a geometry allows the emergency extraction fans to adduct from the compartment in conditions of standard atmospheric pressure. The remaining compartments, whose connections to the ramps stay opened, continue to be ventilated through the “washing” regime of two air changes per hour. If fire extends also to the upper or lower compartment, fire detectors will cause the closing of the connections of that compartment, and they will activate the emergency ventilation procedure of eight air changes per hour, also opening the related shutter which adducts fresh air, as for the first compartment involved in the emergency.

It is interesting to highlight that every compartment has the possibility to independently adduct air for eight changes per hour, and that such a possibility can be activated from a single compartment or from more compartments to a maximum of three (the source of fire and the upper and lower compartments). The remaining compartments will continue their normal ventilation of two air changes per hour through “washing” regime. Eight air changes per hour for each compartment, equal to 28.800 mc, are possible thanks to centrifugal fans.

#### 2<sup>nd</sup> CASE

The fire warning takes place into the entry tunnel or entrance/exit ramps; smoke detectors and Sprinkler dispensers produce the closing of all the connections between compartments and ramps/tunnel. At the same time in the ramp/tunnel compartment a ventilation with direction opposite to that of “washing” ventilation is started in order to remove the combustion smoke and bring it outside; the smoke will cross the tunnel along the entrance way of Via del Teatro Romano, carried by an aspiration system placed on a duct - diameter 1500 millimetres - which goes from the top of the entry tunnel towards the courtyard of the Franciscan monastery (such a configuration of fluxes could also be realized by inverting the spin direction of the axial variable-pitch fans which, placed at the end of the tunnel, during standard management regime assure 2 - 5 air changes per hour into the compartments). In those compartments not involved in the calamitous event, the standard ventilation of 2 air changes per hour will continue through the opening of the shutter that allows to adduct fresh air from the duct coming from Via del Teatro Romano and crossing the REI 180 false ceiling of the entrance/exit tunnel.

#### Conclusion

S. Giusto parking, placed in the old town centre of Trieste, constitutes a fit solution to the increasing requirements of parking demand, mainly in that area of the city centre which currently lacks such a structure. The need to locate the complex under S. Giusto hill represents the only possible choice, both for the urban characteristics of the area and for its position.

The realization of a parking of such size and characteristics requires high economic resources of about € 24.000.000, that is more than usually required by similar structure in elevation, and the Municipality can hardly afford such an expense. Through project financing process and a little public aid to the financial balance of the intervention, it is possible to realize the work of public usefulness.

Since the structure develops totally underground, it produces an increase of the construction costs but limits the environmental impact.

So the choice to realize a parking in cavern can be considered as “intelligent” since it solves at the same time two main issues: the first about logistics, and the second involving the insertion of the work into the environment. The excavated tunnel spoil could be used for environmental reclamation and for earth-fillings in harbour area.

An aspect that has required remarkable study and assessment is represented by the search for a ventilation system which satisfies the law requirements on safety and fire-fighting. Fire-fighting rules and regulations in force establish that natural ventilation through total section ducts, with surface equal to 1/25 of the surface of parking zone and 30% of the surface of aeration for ramps, must be guaranteed. The particular location of the parking determines the impossibility to use natural ventilation through shunt-type pipes, demanding a forced ventilation system. A study has been carried out in order to verify the equivalence of the two methods of ventilation; it has turned out that it is possible to obtain air changes in case of standard management and in case of fire adopting an adequate network of ducts that assures, through helical and centrifugal fans an air volume equal to or larger than that of natural ventilation required by fire-fighting regulations.

#### Reference

[1] Law 109/94, law n. 144/94, law 145/98, law n.443/2001, law n.166/2002, Legislative decree 190/2002.

[2] The Project financing for the public works of A. Vacca – C. Solustri 2003 Simone Edition.

[3] Indagine Geognostica, Studio Geologico, Imprefond S.r.l. May 2002.

[4] Ministerial decree 01/02/86 norms of fire safety for the construction and the exercise of garages and similar.



## High Speed NATM at the Tunnel Nollinger Berg West, Germany

Johannes Horner, Dr.  
Geological Consultant  
Schulweg 15  
A-5081 Anif, Austria  
e-mail: johannes.horner@eunet.at

Manfred Sachs, Dipl.-Ing.  
ÖSTU-STETTIN Hoch- & Tiefbau GmbH  
Münzenbergstrasse 38  
A-8700 Leoben, Austria

### Abstract

The Tunnel Nollinger Berg West (southwest Germany) is an example of rapid advancing by use of NATM. Despite highly varying ground conditions with mixed hard rock and soft ground, excellent excavation velocities were achieved. A flexible tunnelling concept, the existing emergency tunnel within the axis of the tube stabilizing the face, reduced water ingress, and a highly experienced working team were the factors contributing to the success of the project.

**KEYWORDS:** NATM, heterogeneous ground conditions, deformations, advancing rates, emergency tunnel

### Introduction

The 1260 m long twin tubes of the Tunnel Nollinger Berg are part of the connection between the German motorway A98 and the Swiss motorway system (Figure 1).

The JV of ÖSTU-STETTIN, G. Hinteregger & Söhne and Jäger was appointed as contractor to build the western tub, which is scheduled to be completed in 2005. The approximate costs for civil works are EUR 20 millions. The Department of Motorways Bad Säckingen, as part of the State government of Baden Württemberg, Germany, acts as the client of the project.

The Tunnel Nollinger Berg West is aligned about 30 m (distance axis to axis) west of the existing tube, which was opened for traffic in 2002. Three pedestrian cross passages and one larger adit for vehicular access connect the tubes. A 929 m long emergency tunnel, located in the axis of the western tube, was completed in 2003 and had to be removed during construction.

The alignment is characterized by a left curve northwards with a longitudinal gradient inclined towards the North with 3.85 %. The clearance of the tunnel is 7.25 m horizontally and 4.50 m vertically. The excavation face is 87 m<sup>2</sup> in the southern part (designed without an invert) and 100 m<sup>2</sup> in the northern part, where the construction requires an invert and a waterproofing around the full perimeter.

Due to experiences gained during construction of the emergency tunnel and the eastern tube, special attention had to be drawn to the geological and geotechnical conditions. During earlier tunnelling in the area heterogeneous rock and in particular soft ground combined with higher amounts of seepage had caused severe problems with deformations. For this reason a flexible tunnelling concept was needed to facilitate continuous advance and fast and effective reaction in case of dangerous situations.

Figure 1: Location map



### Geology

Geological and geotechnical information needed for design and construction was gathered during site investigation and earlier construction of the eastern tube and the emergency tunnel.

At the southern portal a stretch of about 40 m is characterized by weak debris of sandy to blocky material with a low degree of interlocking.

Following debris a succession of Triassic limestone, porous dolomite and intercalated marl is encountered until about the middle of the tunnel (Oberer Muschelkalk). These rocks are variably weathered with moderately to closely spaced joints of low to medium occurrence. Karstification with open or sandy to blocky-filled joints is present and is associated with faults that obliquely cut the tunnel axis. Seepage is found as dripping water in open joints and on bedding planes.

From the middle of the tunnel northwards, Triassic silt to siltstone and clay-rich marl with irregularly shaped lenses of gypsum-bearing shale and marl (Gipskeuper) are intersected by the tunnel. The marls and silts are weak, frequently of low cohesion and highly deforming, whereas gypsum-bearing shale and marl are stronger. Several parallel faults displace the contact of the two major rock units causing a repetition of the geological sequence. Water inflow in these rocks is associated with the contact of gypsum-bearing lenses and clay-rich silt and marl.

Overburden ranges between 60 m and 30 m with 12 m minimum. Most of the northern part of the tunnel is situated at shallow depth less than 25 m.

Figure 2: Geological section

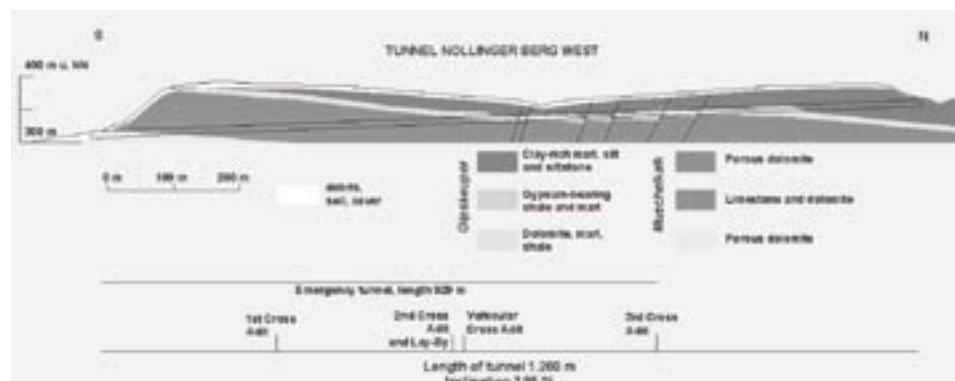

## Tunneling

The contracted JV employed a supervising foremen out of their own staff to enhance JV internal communication and mediate between shift foremen (7 men/shift), workshop and site management with the target of improving productivity.

Tunnelling started in August 2003 from the southern portal northwards.

An umbrella arch, consisting of 4 stages of 15 m long pipes (114 mm in diameter), was required to safely advance through the weak debris. Additionally, rock bolting ahead in the face, a temporary invert, thick layers of shotcrete (up to 250 mm) sprayed to the face, as well as excavation by limited face sections were necessary.

Driving in hard rock was performed by drill and blast using a twin-boom Atlas Copco 352 S. Between 30 to 80 kg of explosives were used in one round of advance of the top heading (length of advance usually 1.0 to 1.5 m). To secure jointed and partly weathered rock, 3 to 4 m long fore-poles were regularly emplaced at the crown. Overbreak was marginal due to good workmanship and favourable joint sets. Deformation was moderate with 22 mm of maximum settlement in the crown.

Up to 8 rounds/24 h in hard rock with 1.5 m of length of excavation could be achieved.

Driving through heterogeneous ground in the northern part of the tunnel required a highly flexible excavation and support concept. Mixed face conditions at the same chainage were common, thus advancing was performed by drill and blast and excavation using a Liebherr 932 T excavator. Excavation of the bench and the invert had to follow after driving the top heading for about 100 to 150 m.

Rock bolting at the face (up to 12 m straight ahead), fore-poling and a temporary shotcrete invert (up to 25 cm thick) were usually emplaced. Excavating the face was performed successively in 3 up to a maximum of 8 stages to guarantee safe working conditions. In addition, in the middle of the tunnel the emergency tunnel significantly stabilized the face and acted as an oversized bolt within the face.

In these rock conditions deformation frequently showed more than 5 cm of settlement in the crown and 3 to 4 cm of settlement of the walls within 24 hours. Settlement usually slowed down quickly and stopped about 4 to 5 days after initial measurement with up to 13 cm of total vertical movement in the crown. Deformation of the walls was in the range of 2 to 3 cm of horizontal displacement inwards with a vertical displacement component of up to 8 cm. Asymmetric deformation, characterized by higher rates of settlement at one wall, preferentially occurred when excavation at the top heading was started again after several days of excavating the bench and the invert.

Deformation monitoring and analysis was absolutely necessary and an important tool for deciding upon changing or modifying the support system.

In comparison to tunnelling on the eastern tube, water ingress was significantly lower. To avoid any reaction of water with the clay-rich rocks forming mud at the bottom of the top heading, drainage liners and hoses were used for drainage.

Despite the complex framework for tunnelling in the heterogeneous ground, excellent excavation velocities with up to 6 rounds/24 h were achieved (at 1.0 m of length of excavation).

The breakthrough was on April 27<sup>th</sup> 2004, three months ahead of schedule.

#### **Discussion and Conclusion**

Due to highly varying geological and geotechnical conditions at the Tunnel Nollinger Berg West a highly flexible concept was approached to guarantee a safe, continuous and fast advance by use of NATM.

The excavation and support concept facilitated fast and simple actions to prevent any dangerous situations..

In particular monitoring and analysis of deformation was an important tool and truly formed the base for decisions upon support and excavation.

Deformation showed unusual behaviour with high rates and sudden stops. Factors controlling the deformation rates and patterns were not only geological conditions, but also high excavation velocity. In particular the strength of the shotcrete seems to be an eminent factor in controlling rates of deformation.

Although the emergency tunnel had to be removed during advancing, it stabilized the face and acted as an oversized bolt in the face transferring loads longitudinally.

Reduced water ingress also favoured higher excavation velocity. Ground water levels were lowered or changed due to and/or during construction of the eastern tube and the emergency tunnel.

Last but not least, the highly experienced team and the efficient maintenance of the equipment largely contributes to the success at Nollinger Berg West.

## Targets and Methodology of Site Characterisation: Tunnel Rio Tinto, Metro Do Porto

Irmina Pöschl  
A-5020 Salzburg, Austria, e-mail: ipoeschl@eunet.at

Raquel Pais  
GEG, Rua da Alegria, 1930 – sala 4, 4200-024 Porto, Portugal, e-mail: rpais@geg.p

### Abstract

Geotechnical site characterisation for a tunnel project shall provide the base-line information that is required for the excavation and support design and supply a reference document for tender and contract procedures. A concept to meet these requirements was developed for the Rio Tinto Tunnel Project, Portugal, and is presented in this paper. The basic procedural steps include 1) the definition of geotechnical questions relevant for the project, 2) the identification of geological/geotechnical themes that need to be addressed for potential design solutions, and 3) the selection of appropriate investigation methods and tools. To comply with legal and technical demands the rock mass characterisation is based on transparent data evaluation, detailed documentation and reporting, and on a variety of investigation methods applied.

**Keywords:** Site characterisation, rock mass classification, investigation methods and procedures.

### 1. Introduction

Geotechnical site and rock mass characterisation often falls short in providing all the information required for a tunnel project. The specific demands for adequate site characterisation depend on the particular boundary conditions of each project, calling for flexibility in the selection of investigation approaches and methods. To meet these requirements, a tailor-cut approach was developed for site characterisation of the Rio Tinto Tunnel Project that is part of the Metro system in Porto, Portugal. The project is currently at tender stage, and the investigation and design works for the tender design were performed between 2001 and 2003. The 1km long tunnel alignment is situated in an urban environment and underpasses - with a maximum overburden of 20m - two railway lines, one major road and a shopping centre, which was still under construction during the tender design phase. The western section of the tunnel alignment passes through granites, before crossing the intrusive contact between granites and schists that was tectonically overprinted. The eastern alignment section is located in schists, gneisses and migmatites that were affected by contact metamorphism and intersected by granite dykes.

### 2. Scope of Work and Methodology

The main target of the geological-geotechnical study was to provide all geotechnical information required for a detailed tender design, including the tunnel excavation and support design as well as related specifications and quantities. In addition, the document should serve as a reference model for transparent tender and potential claim/arbitration procedures and as base-line information for the construction contract.

The basic procedural steps of the applied approach included 1) the definition of geotechnical questions relevant for the project, 2) the identification of geological/geotechnical themes that need to be addressed for potential design solutions, and 3) the selection of appropriate investigation methods and tools. Geotechnical questions found relevant for the project were correlated to geological/geotechnical themes (Table 1) that were then considered for the site investigation program (Table 2). Special emphasis was directed towards the description of typical rock mass behaviour and failure modes and towards the development of a clearly defined geotechnical model. Both of these items often lack adequate consideration in the frame of site characterisation.

Table 1 – Geotechnical questions and themes



### 3. Investigation Methods

Standard site investigation techniques included the sinking of boreholes, SPT testing, insitu permeability testing (Lugeon and Lefranc), refraction seismic survey, the collection of intact and disturbed samples, and laboratory testing on soil and rock samples. Complementary methods, such as aerial photo analysis, detailed outcrop mapping, and a well survey were applied to provide more information on failure modes, rock mass behaviour, ground related risks, and on the distribution of rock mass classes along the alignment. The results and data evaluation/interpretation of these complementary methods and their significance for the overall site characterisation are discussed in this paper. For details on standard site investigation works refer to [9].

Table 2 – Investigation methods

Investigation Methods	Geological/Geotechnical Themes							
	Lithology	Water	Alteration	Fracturing	Strength	Discontinuities	Faults	Stress
Literature	XX	X	X		X		X	XX
Aerial photos							XX	X
Outcrops	XX		X	X	X	XX	XX	
Well survey	X	XX	X		X			X
P-wave seismic			X	X			XX	
S-wave seismic			X	X	XX		X	
Boreholes	XX		XX	XX		X	X	
SPT testing			X		XX		X	
Permeability testing								X
Laboratory testing	X				XX			

#### 3.1 Aerial Photos

Stereoscopic aerial photographs in scales 1:33,000 and 1:15,000 allowed for the clear distinction of three main sets of lineaments (Figure 1-a) that correlate well to regional fault patterns. Data from seismic survey, outcrops studies and boreholes

confirmed that several faults or fault zones intersect the tunnel alignment where this was indicated by photo lineaments. Trends and significance of faults as interpreted from photos lineaments supported the development of a geological model (Figure 1-b, geological map) and the assessment of geotechnical conditions along the alignment (geotechnical model, see Section 5).

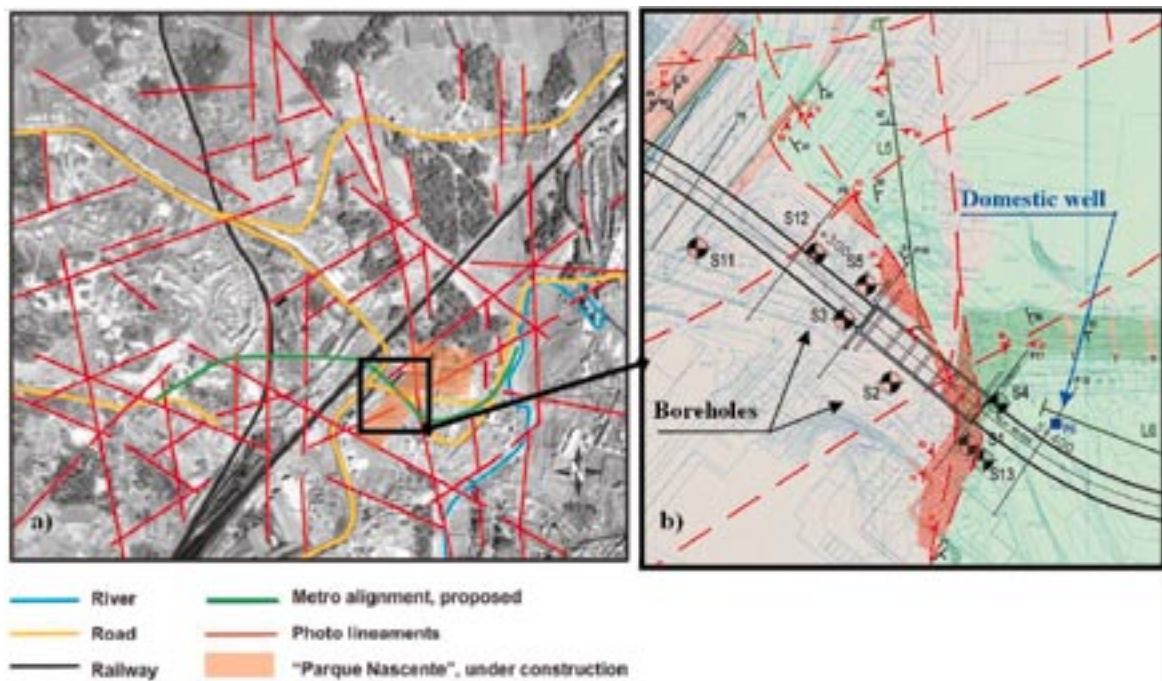

Figure 1 – a) Photo lineaments, b) Geological model / map

### 3.2 Outcrop Logging

With natural outcrops usually being rare in urban environments the large excavation for a shopping centre under construction above the central alignment section excellently supplied detailed geological and geotechnical data. The pit served as a “real-time” and “full-scale” laboratory, where failure modes of exposed soil-like and jointed rock mass could be observed. Artificial excavations laid open large sections of the main fault intersecting the alignment and the intrusive granite/schist interface. The cut slopes exposed materials that are rarely recovered from boreholes, such as fault materials and completely disintegrated granite.

Structural logging of outcrops provided a representative amount of discontinuity data (no. 248) for statistical analysis. Pole diagrams and statistical cluster evaluation (Figure 2) indicate distinctly different discontinuity patterns for the granitic and the schistose alignment section. The dominant discontinuity sets were used for kinematic analysis assessing the potential for wedge/block failure during tunnel excavation (see Section 4.4).

Outcrop logging further supplied details on discontinuity characteristics (roughness, spacing, persistence, aperture, and infilling, etc. [7]) that are essential for most rock mass classification schemes (e.g. RMR and Q [1], GSI [2], [5]) and for the estimate of shear parameters along discontinuity planes.

Figure 2- Discontinuity sets, pole diagrams – a) granite and b) schist

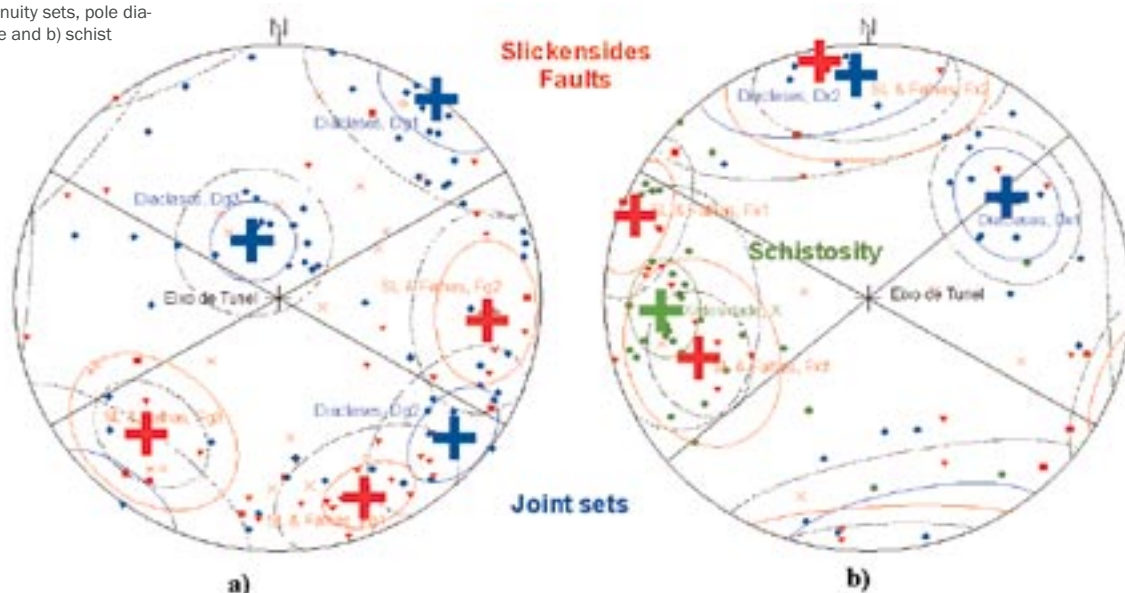

### 3.3 Well Survey

A survey of water wells was performed along the tunnel corridor with documentation of exact location, owner, current and previous use of the well, dimensions, depth, lining characteristics of the structure and water level within the well. The data collected allowed conclusions on ground water levels, on the permeability of the various materials and even on local influence of faults on water levels and hydrostatic gradients. With most of the wells being abandoned and out of use after provision of public water supply the largest concern related to tunnel construction was the encounter of unknown wells during tunnel excavation that could lead to sudden and large-scale water inflow, de-stabilization of the ground and collapse potential. Several wells that were identified to reach into or close to the tunnel alignment (see Figure 1-b, geological map) must be treated / filled before tunnel construction commences.

## 4. Rock Mass Classification

### 4.1 Definition of Geotechnical Units

For the development of a suitable excavation and support design eight geotechnical units were defined following in principle the guidelines of the Austrian Society of Geomechanics [8]. G1a, G1b, G2, and G3 stand for granitic, X1a, X1, X2 and X3 for schistose rock mass. The geotechnical units reflect “rock mass behaviour types” [11] that relate to rock mass of similar characteristics and behaviour patterns, taking into account not only geomechanically relevant rock mass properties, but also project-specific aspects of ground water, shape, size and orientation of the excavation and insitu stresses acting around and on the tunnel structure. The counteraction between these factors determines rock mass behaviour patterns, which are considered typical for each individual geotechnical unit and require specific excavation and support measures.

### 4.2 Rock Mass Characteristics and Standard Rock Mass Classification

Macroscopic rock mass characteristics that can be distinguished and described in drilling cores and at the excavation face were selected as classification criteria for



the definition of the geotechnical units. The basic classification criteria are lithology, the degree of alteration/weathering, the degree of fracturing and RQD values. On the base of these basic and other rock mass characteristics RMR [1] and GSI [2], [5] classification was performed for each geotechnical unit (Table 3), permitting correlations to internationally applied classification schemes and supporting the assessment of rock mass parameters (see also Section 4.3).

Table 3 – Basic classification characteristics and standard classification

Geotechnical Unit	Basic Classification Characteristics				Standard Classification	
	Lithology	Alteration	Fracturing	RQD	RMR	GSI *
G1-a	Granite	W1, W2	F1, F2	>90%	II	70
G1-b		W2, W3	F2, F3	50-90	III	60
G2		W3, W4	F4, F5	25-75	IV	40
G3		W4, W5	na	<25	V	10
X1-a	Schist	W1, W2, W3	F2, F3	75-100	III	40
X1-b		W2, W3	F3, F4	50-90	IV	30
X2		W3, W4	F4, F5	<50	IV	20
X3		W4, W5	F5, na	0	V	10

\* ...mean value

### 4.3 Design Parameters

Parameter ranges with upper and lower boundary values were determined for intact rock, for soil-like and jointed rock mass (geotechnical units) and for discontinuity planes. Intact rock properties derived from laboratory tests serve as input data for kinematic discontinuum modelling, for standard rock mass classification [1] and for the assessment of rock mass parameters [2], [5]. Rock mass properties (RQD, discontinuity spacing, persistence, surface conditions, etc.) determined from borehole and outcrop logging supply input data for RMR and GSI classification. Design parameters for soil-like materials such as completely disintegrated granite were assessed from laboratory tests and from insitu testing (N300 values, [6], [12], [13]).

### 4.4 Typical Failure Modes

Two standard failure modes – rock mass failure and wedge/block failure – typically control the rock mass behaviour during tunnel excavation. The failure potential for these failure modes was quantitatively assessed for each geotechnical unit. Overall deformation and the potential for rock mass failure related to low rock mass strength was estimated according to Hoek ([3] [4]) and simulated by FLAC calculations. The potential for discontinuity controlled wedge/block failure in jointed rock mass (Figure 3-a) was determined by UNWEDGE [10] calculations (Figure 4).

### 4.5 Atypical Failure Modes and Ground Related Risks

In addition to these typical failure modes, specific failure modes that may occur in relation to particular boundary conditions were identified. Erosional/piping failures may develop in association with elevated water pressures or steep hydrostatic gradients in soil-like, disintegrated granites (see Figure 3-b). This failure mechanism may be drastically enhanced by the encounter of undocumented wells reaching into or close to the tunnel excavation. Lateral relaxation sliding may take place along low-strength schistosity planes in tectonised schistose rock mass. The potential for

these specific failure modes was estimated with respect to field observations and experiences reported from similar ground conditions. The description of atypical rock mass behaviour and related risks permits the designer/contractor to foresee special support/construction measures that may be required to cope with specific conditions but are not economical for routine application in standard support classes / design.

Figure 3- a) Discontinuity controlled block / wedge failure in jointed granitic rock mass, b) Erosional / piping failure in disintegrated soil-like granitic rock mass.



Figure 4- Kinematic assessment of potential for block/wedge failure, UNWEDGE [10].

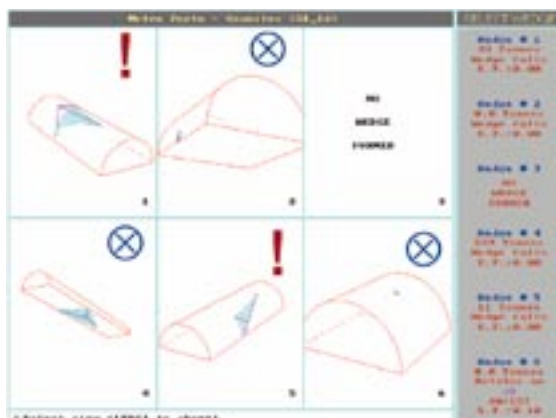

### 4.6 Rock Mass Behaviour

The rock mass behaviour predicted to occur during tunnel excavation (Table 4 for typical behaviour in geotechnical units of granitic rock mass) takes into account the potential failure modes, influence of ground water (e.g. enhancing piping), general potential for deformation and surface settlements (e.g. in relation to dewatering), and specific conditions that may effect excavation and design considerations (e.g. mixed-face conditions at tunnel face).

Table 4 – Schematic summary of rock mass behaviour – geotechnical units G1 to G3

Geotechnical unit	Rock mass behaviour
G1 (a&b)	Stable to over breaking, locally friable. Discontinuity controlled wedge failures. Locally "piping" of W5 granite along joints and in association with water. Low deformation potential
G2	Friable to very friable, locally raveling to running Discontinuity controlled wedge failures, locally rock mass failure and piping in W5 pockets, especially in association with water Low to moderate deformation behavior Mixed-face conditions with soil-like and jointed rock mass at tunnel face
G3	Raveling to rapidly raveling, locally running Rock mass failure and/or piping Moderate to high deformation potential. Potential for surface settlements in association with groundwater drawdown

**4.7 Classification Sheets**

The description of geotechnical units in classification sheets, as shown in Figure 6, provides answers to most of the previously defined geotechnical questions by summarizing all of the key aspects discussed above. Interpretative information including the assessment of failure modes, rock mass behaviour and ground related risks can be directly related to factual data on rock mass characteristics and circumstantial aspects. Schematic conditions during excavation and typical failure modes are displayed in a sketch. The conclusive information supplied in the classification sheets allows for the determination of individual support items required for each geotechnical unit and respective support class.

**5. Geological / Geotechnical Model**

The geological/geotechnical model presented in the longitudinal section defines geotechnical domains that are characterized by the estimated percentile distribution of geotechnical units (Figure 5). Factual data relevant for the interpretation and rock mass classification, such as RQD, degree of fracturing, N300 values from boreholes, are shown in the longitudinal section. The distribution of the geotechnical units and respective support classes permits the assessment of construction time, total quantities and eventually construction cost.

Figure 5 – Section of geological/geotechnical model

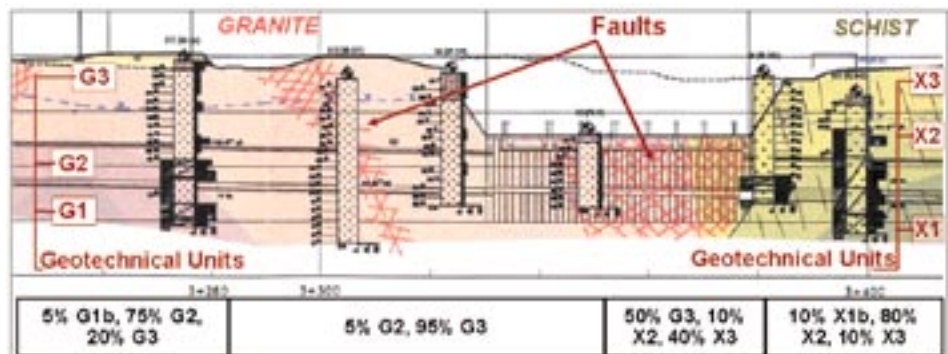

## 7. mednarodno posvetovanje o gradnji predorov in podzemnih prostorov

### TEMA 2 | NAČRTOVANJE KONSTRUKCIJ IN VZDRŽEVANJE PODZEMNIH PROSTOROV

<b>Geotechnical Unit:</b>		<b>X3</b>		
<b>Lithology:</b>		Mica schists, sericitic schists, migmatitic gneissic schists intersected by granitic dykes. Weathering grades W4, W5 prevailing.		
<b>Discontinuities:</b>				
Schistosity:	Anisotropy:	high	Joints:	
	Spacing:	< 60mm		Sets:
	Persistence:	10 - 20		Spacing:
	Conditions:	undulating, polished		Persistence:
	Opening:	< 5mm		Conditions:
	Filling:	soapy surfaces, plastic clay		Opening:
			Filling:	
<b>Intact Rock Parameters:</b>				
	Density (g/cm <sup>3</sup> ):	2.0 - 2.4		
	UCS (MPa):	< 5		
	T (MPa):	< 1.5		
	Abrasivity:	heterogeneous, typically low	estimated, no data	
<b>Discontinuity Parameters:</b>				
	c (MPa):	0	estimated	
	f (°):	20	estimated	
<b>Rock Mass Parameter:</b>		Refer to report.		
<b>Standard Classification:</b>				
	GSI:	10-20		
	RMR:	V		
<b>Rock Mass Characteristics:</b>		Highly anisotropic rock mass, highly tectonised.		
<b>Schematic Sketch:</b>				
<b>In situ Stress:</b>	In situ stress usually exceeds overall rock mass strength.			
<b>Water:</b>	Joint water. Damp to wet, dripping to flowing from granitic dykes. Water inflow typically below 5l/s, rarely up to 15l/s per 100m. Local water inflow from pegmatitic dykes, fractured zones and/or interface joints/soil-like rock mass may reach 10l/s to 20l/s. Water within granitic dykes likely to be confined and subject to high water pressures.			
<b>Rock Mass Behaviour:</b>	Very friable, rapidly ravelling, squeezing (depending on overburden). Relaxation sliding along low-strength schistosity planes. Stress induced failures of low-strength rock mass, enhanced by heterogeneous stress distribution related to shear planes and faults.			
<b>Remarks:</b>	Erosion/stress induced failures enhanced in association to granitic dykes (W5/W4). Mixed face conditions.			

Figure 6 – Definition sheet, Geotechnical Unit X2

### 6. Conclusions

The site characterisation of the Rio Tinto Tunnel Project was targeted to provide the base-line information required for the excavation and support design and to supply a reference document for tender, contract and potential arbitration procedures. The presented geotechnical model delivers a reasonably reliable prediction of conditions along the alignment as well as the assessment of rock mass behaviour and ground related risks that are relevant for design considerations. The applied methodology combined well-proven standard techniques with complementary applications under consideration of project-specific conditions and requirements. The basic procedural steps were (1) the initial definition of geotechnical questions relevant for the project, (2) the identification of geological/geotechnical themes that need to be addressed to contribute to potential solutions, and (3) the selection of appropriate investigation methods and tools. The diversity of applied methods, detailed data analysis/documentation/reporting, and statistically relevant statements allow for the required transparency, which gains in significance, as contractual claims in large civil engineering contracts become increasingly common.

### Acknowledgements

Reference is made to the project owner “Metro do Porto” for the friendly permission to publish project specific data.

### References

- [1] Bieniawski Z.T.: Engineering Rock Mass Classification. – John Wiley & Sons, 1989.
- [2] Hoek E., Brown E.T.: Practical Estimates of Rock Mass Strength. Int. J. Rock. Mech. & Mining Sci. & Geomec. Abstr. 34 (8), 1165-1186, 1997.
- [3] Hoek E.: Big Tunnels in Bad Rock. Terzaghi Lecture, ASCE, 2000.
- [4] Hoek E.: A discussion on acceptability criteria for temporary support and final linings of large span transportation tunnels in poor rock. – Vancouver, March 1999.
- [5] Hoek E., Marinos P.: Predicting Squeeze. – Tunnels & Tunneling International, November 2000.
- [6] Hunt R.E.: Geotechnical Engineering Investigation Manual. McGraw-Hill, 1984.
- [7] ISRM: Rock Characterization Testing and Monitoring. ISRM Suggested Methods (Ed. E.T.Brown). Pergamon Press, 1981.
- [8] Österreichische Gesellschaft für Geomechanik: Richtlinie für die Geomechanische Planung von Untertagearbeiten mit zyklischem Vortrieb. – Herausgegeben anlässlich des 50. Geomechanik Kolloquiums, Oktober 2001.
- [9] Pöschl I., Pais R.: Site characterization and project-specific rock mass classification, Rio Tinto Tunnel, Metro do Porto. – ISC'2, Porto, September 2004.
- [10] Rock Engineering Group, Department of Civil Engineering, University of Toronto. Unwedge, Version 2.2, by J.L. Carvalho, E. Hoek, Bin Li, 1992 – 1994.
- [11] Schubert Wulf, et.al.: Consistent Excavation and Support Determination for the Design and Construction of Tunnels. – Felsbau 5, October 2001.
- [12] Shioi Y., Fukui J.: Application of N-Value to Design of Foundations in Japan. Proc. of 2nd European Symposium on Penetration Testing. Amsterdam, 1982.
- [13] Stroud, M.A.: The Standard Penetration Test – Its Application and Interpretation. – Penetration testing in the UK, 29-49, Thomas Telford, London

## Design of a 13 km Long Railway Tunnel

Josef Daller, Dipl. Ing.  
iC consulenten Ziviltechniker GesmbH Vienna, Austria  
A-1070 Vienna, Kaiserstrasse 45  
Tel.: +43 1 52169 106  
Fax: +43 1 52169 15

### Abstract

The paper deals with the main aspects for the design of modern railway tunnels. Key issues are the selection of the tunnel system (single or double track tubes), the design of an adequate cross section profile considering clearance requirements, geotechnical conditions, aerodynamic aspects and track work systems, as well as the design of safety and emergency facilities. A general description is given for the design of the 13 km long Wienerwald Railway Tunnel.

KEYWORDS: Railway tunnel, aerodynamics, tunnel cross section, safety and emergency facilities, fire hazard, vibration control, risk analysis

### 1. Introduction

The more than 13 km long Wienerwald Railway Tunnel Project comprises two single track tunnels, each about 10.900 m long, a 2.236 m long double track section with a 409 m long enlarged cross section at the transition to the twin tubes, a ventilation cavern with a permanent ventilation (smoke extraction) shaft, three optional temporary ventilation shafts during construction, three permanent emergency exits, 22 cross passages connecting the single track tubes at every 500 m spacing, an inclined mucking gallery equipped with conveyor belts and a temporary construction access in case of conventional excavation (see also Fig. 3). For the tender of the project three construction lots were combined (Lot WT2, Lot LT26 and Lot TF3) into one bidding contract. The geological conditions along the tunnel are characterized by Molasse and Flysch formations. The tunnel will cross several extensive fault zones. The overburden ranges from about 10 to 200 meters. The biggest geotechnical challenges will be the tunnel driving in those fault zones with up to 200 m cover.

The project was tendered in autumn 2003 with two design alternatives regarding the construction method applied. For the long single track tunnels design drawings and tender documents were prepared for using either a tunnel boring machine (TBM) or applying NATM. It was the first time in Austria, that a full set of tender documents were prepared for two design alternatives.

The contract was awarded in June this year for the TBM-alternative and preparation for construction at the eastern section started in August.

### 2. Design Aspects for Railway Tunnels

The design of railway tunnels in Austria is generally based on our national standard for the "Design of "High Capacity Railway Tunnels" [1], national codes and design guidelines and on respective UIC-codes.

Designing modern High Speed or High Capacity Railway tunnels special attention has to be paid to following aspects:

- Tunnel system (single tube double track tunnel or twin tube single track tunnels)
- Aerodynamics for design of regular cross section and minimum inner clearance)

- Safety facilities and emergency exits
- fire hazards
- Track work design including vibration control
- Tunnel lining

### 2.1 Decision on tunnel system

For long tunnels the decision on the system has to be made at a very early stage (e.g. idea project, environmental impact assessment). The decision whether to design a single tube double track tunnel or two single track tubes is mainly controlled by the necessary emergency safety system, traffic capacity during maintenance and economic facts. Longer single tube tunnels need emergency exits at certain intervals. The emergency exits can either be vertical emergency shafts, horizontal or inclined emergency adits, cross passages to a parallel emergency gallery or cross passages to the parallel line tube in case of a double tube tunnel.

Vertical escape shafts and short horizontal emergency adits are only possible in sections with shallow cover (e.g. Lainzer Tunnel in Vienna). Comparing the construction cost of 2 single track tubes versus a double track tube with a parallel emergency gallery the first solution could be slightly cheaper. However for tunnels longer than 10 to 15 km parallel single track tubes will have advantages for operation in case of maintenance and fire emergency.

### 2.2 Aerodynamic requirements

A train passing a tunnel causes a very complex unsteady flow field. The pressure transients are mainly produced by the entrance and exit of the nose and the tail of the train, but the passing of trains in the tunnel causes additional waves. The compression and expansion waves propagate along the tunnel with the speed of sound relative to the local airflow. These sonic waves are reflected at the ends of the tunnel and partly reflected if passing a nose or a tail of a train. A compression wave is reflected at a tunnel portal as an expansion wave, a rarefaction wave is reflected as a compression wave. This results in a very complex superposition of waves. For waves of the same sign the interference is additive and may cause severe pressure gradients in a short time. Moreover, the induced flow in the tunnel increases the aerodynamic drag of the train during the passage.

According to UIC-Code 779-11 the minimum cross section area of a tunnel profile has to be calculated during the preliminary design phase considering aerodynamic effects. In Austria the following permissible pressure changes are specified for common (not pressure tight) railway carriages:

- Double track tunnels: 4000 Pa/4sec
- Single track tunnels: 2500 Pa/4sec

For high comfort sealed IC trains the proposed limited pressure changes are lower.

For a design speed of 200 km/h (maximum speed = 250 km/h), a tunnel length of 10 km and using a concrete track slab the following minimum inner cross section areas are required:

- 44,2 m<sup>2</sup> for a single track tunnel, and
- 76,5 m<sup>2</sup> for a double track tunnel

In double track tunnels in Austria the distance between the track axes is 4.70 m. However, reducing the spacing between the tracks would not result in a smaller tunnel profile, since the required cross section areas are controlled by aerodynamic aspects. For most of the new railway tunnels (single and double track) in Austria either aerodynamic requirements or clearance requirements for the catenary wires in the tunnel roof control the size of the tunnel cross section.

#### 2.3 Safety facilities

For tunnels longer than 500 m an emergency escape system must be designed. The maximum spacing of escape exits is specified with 500 m.

In a single tube tunnel either vertical emergency shafts or horizontal (gradient < 10 %) emergency galleries (clearance profile 2,25 x 2,25 m) must be provided for. If emergency galleries are longer than 150 m they must be enlarged (clearance profile 3,60 m x 3,50 m plus walkway 1,20 x 2,20 m) so that ambulance cars and small fire brigade cars can enter the galleries.

In parallel single track tunnels cross passages between the tubes serve as emergency escape routes. The cross passages must be closed at either sides by doors. The space between the doors must be at least 12 m long. The ventilation fans installed in each cross passage and emergency adit must have the capacity to keep the escape routes free of smoke in case of a tunnel fire.

For very long tunnels (exceeding 20 km) complex underground emergency stop facilities have to be designed.

#### 2.4 Fire hazards

##### a) Fire fighting facilities

For fire fighting in case of a tunnel fire each tunnel tube must be equipped with one water main. The water mains are normally placed in a cable duct near a side wall or in case of a double track tube between the tracks. Hydrants are located at the tunnel walls or in niches with maximum spacing of 150 m. The water pressure at the hydrants is specified with 6 to 10 bars.

##### b) Structural design

Tunnel structures shall be designed and dimensioned that in case of a tunnel fire the damage of the tunnel is limited, third parties (e.g. user of a road above the railway tunnel) will not be affected and the period of a tunnel closure for repair will be the shortest possible.

The design targets shall include the following topics:

- maintain stability of the structure for a defined period, in order to allow passengers to escape and to evacuate buildings or infrastructures on top of the tunnel
- limit deformations of the structure and surface settlements
- avoid tunnel collapse if this affects surface structures
- maintain water tightness for submersed tunnel
- enable the possibility for repair considering costs and time



**c) Design fire**

In several European countries design fires (temperature curves versus time) are defined. In the Austrian standard presently under revision a temperature versus time curve for mixed traffic (passenger trains and cargo trains are operated on the respective railway line) called “EBM” will be specified (see Fig. 1). The duration of the design fire considered for the structural design of the tunnel lining is influenced by several factors (see protection levels and classification matrix in Fig. 2)

**d) Protection Levels**

Five protection levels are defined:

- Protection level 0: no effect on surface structures or third parties
- Protection level 1: only minor structures or infrastructure on the surface might be affected
- Protection level 2: major structures (e.g. residential buildings) and infrastructures (e.g. main roads, railway lines etc.) above the tunnel might be affected
- Protection level 3: major buildings with difficult evacuation (e.g. hospitals, schools, airports, etc.) and important infrastructures (e.g. main water supply line) above the tunnel might be affected; or submersed tunnels (e.g. river crossing, tunnel under ground water table etc.)
- Special cases: buildings above the tunnel with extreme long time needed for evacuation, or projects which cannot be repaired after a tunnel fire (e.g. river crossing or under sea tunnel with shallow cover)

Fig. 1: Design fire acc. to proposed Austrian Guideline

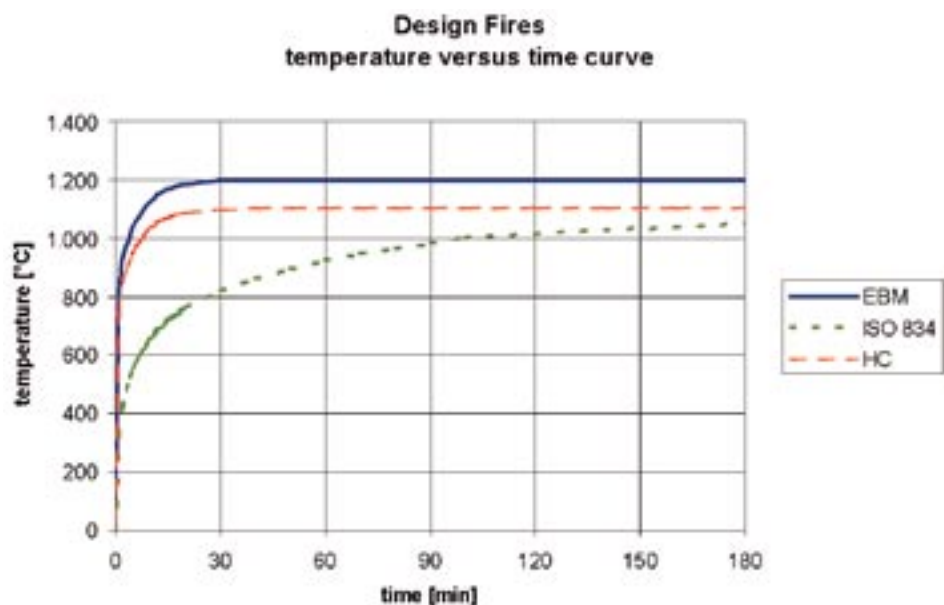

**e) Possibility for Repair**

This classification considers the possibility for repair or reconstruction of an affected tunnel with respect to necessary time, repair costs and accessibility.

- Type A: easy repair/reconstruction
- Type B: difficult repair/reconstruction

### f) Specification of design fire for structural design of tunnel linings

The design fire considered for the structural design of tunnel linings shall correspond with the levels as specified in the table below.

Fig. 2: Classification matrix for design fire

Protection level	Possibility for repair	Mined tunnels longer than 200 m	
		Diversion of traffic not possible	Diversion of traffic possible
0	Type A, B	no design required	no design required
1	Type A	EBM x min *)	EBM x min *)
	Type B	EBM 60 min	EBM x min *)
2	Type A	EBM 90 min	EBM 60 min
	Type B	EBM 120 min	EBM 90 min
3		EBM 180 min	EBM 150 min
Special cases		Special design considerations	

\*) duration of design fire as required for evacuation of buildings and infrastructures above the tunnel (time needed for intervention at the ground surface above the tunnel)

### g) Measures for structural fire protection

Without any special protection or measures un-reinforced or reinforced tunnel lining can withstand temperatures beyond 1000 °C only a very limited time until progressive spalling of the concrete starts.

In the recent year extensive research and testing programmes were carried out to find technical sound and economic solutions for fire protection and avoidance of spalling.

Basically 3 different solutions were investigated:

- Application of fire protection panels or layers of protective material
- Increasing the concrete cover for the inner layer of the structural reinforcement and to add an additional layer of net reinforcement to avoid spalling
- Adding Polypropylene fibres to the concrete mix (can also be applied with un-reinforced lining)

Results of large scale fire tests showed that adding polypropylene fibres is the most effective and also a very economic solution to avoid spalling and keep the temperature of the reinforcing steel and concrete at an acceptable temperature.

Special attention has to be paid to the workability (pumping, compacting) of the concrete by adding polypropylene fibres (about 1.8 to 2,0 kg fibres/m<sup>3</sup> concrete).

### 2.5 Track work design including vibration control

Special attention has to be paid to vibration control in sections where the tunnel passes underneath residential building or structures with sensitive installations. Tracks and track beds have to be customized in order to keep vibration and noise emissions below acceptable limits For installation of “mass-spring systems” rather deep invert arches are required (see also Fig. 4).

### 2.6 Tunnel lining, water proofing and drainage system

Especially using a shielded Tunnel Boring Machine with a segmental lining the

designer and client (owner) have to decide whether to apply a single or double shell lining. This decision has to be made in a close context with the drainage and water proofing system.

For the Wienerwald tunnel project a risk analysis and cost comparison was made for selecting the proper lining in case of TBM – drive. The analysis showed clearly that a double shell lining consisting of prefabricated concrete segments with “open joints” and an in-situ inner lining is the best solution. Except at intersections with cross passages and in heavy squeezing ground conditions the cast-in-place inner lining is unreinforced. A water proofing membrane will be installed between outer and inner lining and the mountain water will be drained off by longitudinal drainage pipes either at both side walls or in the invert.

### 3. Wienerwald Tunnel Project

#### 2.1 General

For the tender 3 construction lots were combined and tendered together:

- Lainzer Tunnel Lot LT26: double track tunnel, 1.717 m long
- Wienerwald Tunnel Lot WT2: double track tunnel, 110 m long  
enlargement of double track tunnel, 409 m long  
single tube tunnels, each about 10.900 m long
- Tullnerfeld Lot TF3: earth works (embankment for railway line, noise protection walls) using tunnel excavation material from about 2 times 5 km single track tubes

The project was tendered in two design alternatives. It was the first time in Austria that full sets of tender documents were prepared for different construction methods. For the single track tunnels from the western portal to the emergency ventilation cavern design drawings and tender documents were prepared for using either tunnel boring machines (TBM`s) or applying the NATM.

In order to be able to compare and evaluate the bids for the different construction methods a risk assessment was carried out for both design alternatives. The risk assessment considered geotechnical conditions impairing tunnel stability or construction progress, damage to the tunnel lining, problems during tunnel driving and impact on environment and on surface structures. Acceptable, potential risks which could not be eliminated during the design process were quantified and considered as surcharge in the bid evaluation. Risk sharing between the contractor and the client were clearly stipulated in the tender documents. For bid evaluation only remaining risks for which the client is responsible were taken into account.

Submission date for the construction tenders was end of February 2004. Only four bidders submitted their offers. The bidding groups come from Austria and Germany, with subcontractors from Sweden and Switzerland. One bidder submitted offers for both alternatives, the other three groups submitted only Alternative B with the application of TBM`s.

The contract was awarded in June this year for the TBM-alternative and preparation for construction at the eastern section started in August.

The general layout of the project is shown schematically on Fig. 3. Typical tunnel profiles for single and double track tubes are given on Fig. 4 and 5.

#### 3.2 Geotechnical Conditions

For most of the tunnel length the geotechnical conditions for using a shielded tunnel boring machine are rather favourable. The flysch and molasse are low to medium strength rock types and will allow average daily advance rates of more than 20 meters.

The nominal bore-diameter was specified with 10,63 m including all tolerances for TBM-driving and placing of the inner concrete lining. Two of the bidders offered a single shield machine, the other two a double shield machine. Finally a single shield machine will be applied.

From the geotechnical point of view the real challenge will be the crossing of the major fault zones. In the worst case the fault zone is nearly 100 m wide and the overburden reaches about 200m. The main risk is that the shield will get stuck due to high convergence. In the fault zones the 35 cm thick prefabricated segments must be designed to take rock loads up 1450 kN/m<sup>2</sup>.

Based on the risk analysis minimum requirements for the tunnel boring machines were specified in the tender documents, such as

Minimum torque of cutter head (for the range of 0 – 2 r/min): 8.000 kNm

Minimum torque of cutter head for start up (for at least 60 sec): 15.000 kNm

Minimum total thrust per meter of shield length: 10.000 kN

Minimum design load (rock pressure) for tail shield: 600 kN/m<sup>2</sup>

Minimum range of over excavation: 10 cm

In addition the TBM must be equipped to install an inclined pipe roof umbrella and inclined rock dowels through the shield as close as possible to the cutter head (for the rock dowels the maximum distance from the front end of the shield was specified with 3,5 m).

An open type TBM with a gripper system was not allowed in the bidding documents.

#### 4. Conclusion

Long railway tunnels need careful design procedures through all design phases in order to get an economical project which fulfills all requirements with respect to environmental protection, safety of passengers, train operation and maintenance. The experience at the Wienerwald Tunnel Project showed that it is worthwhile to study carefully different suitable constructions methods in order to get the most economic bidding price. Design alternatives prepared by contractors during a rather short tender period are normally not in sufficient detail for tender evaluation and contract award.



Fig. 5: Regular tunnel profile for single track TBM-tunnel (allowing for a mass-spring-system)

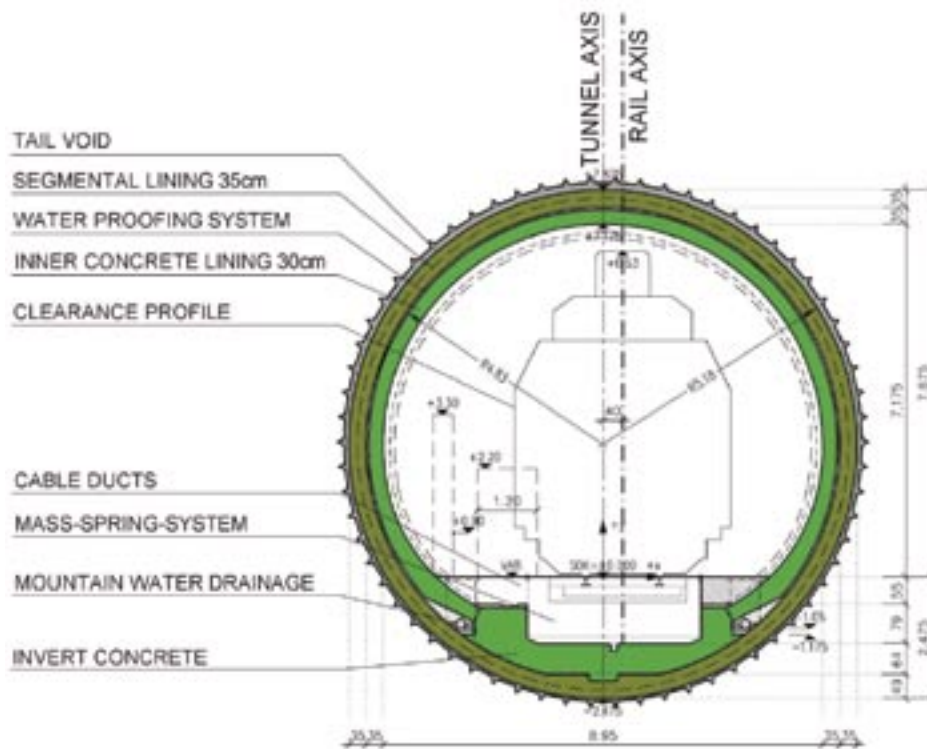

### References

- [1] HL-AG, ÖBB, BEG, Richtlinie für das Entwerfen von Bahnanlagen – Hochleistungsstrecken, May 2002
- [2] Lemmerer J., Kusterle W., Pebersdorfer H., Brandschutz im Tunnelbau, Betontag 2002
- [3] Vavrowsky G.M., Ayaydin N., Schubert P., Geotechnisches Sicherheitsmanagement im oberflächennahen Tunnelbau, Felsbau 19 (2001) Nr.5
- [4] PGWT (Planungsgemeinschaft Wienerwald Tunnel), Risikoanalyse Wienerwaldtunnel, 2003
- [5] Daller J., Risk Control at the Design of a 13 km long railway tunnel in Austria, Course on Geotechnical Risks in Rock Tunneling, Avairo 2004, Portugal
- [6] ÖVBB, Erhöhter Brandschutz mit Beton für unterirdische Verkehrsbauwerke, Entwurf 4.0, 2.7.2004

## Development of privately financed subway lines and possible application on Light-Rail Zagreb Project

Davorin Kolić  
Neuron ZT, Pasching / Austria  
Stipan Matoš  
City Council of Zagreb, Zagreb / Croatia  
Davor Kراسić  
City Council of Zagreb, Zagreb / Croatia

### Abstract

Subway systems represent large infrastructure projects demanding major financial investments. Public sector has traditionally been providing financial sources for such projects. However with increasing demand for subway construction in major cities around the world, the need for private financed investment is growing. Private sector provides increasing financial sources in infrastructure projects including subway construction. Risks which were traditionally accepted by the public sector are now getting incorporated into private responsibilities. For reasons of successful investment by the private sector cost estimates need to be combined with phased risk analysis. A realistic cost estimate can prepare the path for project failure in the early phase. The paper discusses innovative considerations and recommendations for infrastructure investments using risk analysis as an advanced management tool through the life of the project.

### 1. Introduction

Public transportation projects demand major financial investments. Subway lines are infrastructure projects that should be built within a reasonable period of time (e.g. ranging from of 4 to 6 years for a section of approx. of 5-7 km length). Planning, organization, design and legal requirements can take up to approx. 7-10 years prior to the beginning of the construction. The public sector faces major problems to finance such projects due to budget and time constraints.

In order to realize successful project implementation there is a need to carefully examine schedule prolongation. This risk can be reduced by reducing the time necessary for financing. Financial problems of schedule slippage can be controlled in such projects by using as a contract model "private-public-partnership (PPP)", whereas project financing comes from private financial institutes. Such institutes may be represented by individuals or by bank consortia who are interested to put funds on the market provided that a defined risk is covered by the public sector, and whereas other risks are covered by the private sector. This allows for the investment of capital over a longer period of time.

The prerequisite for successful investment is represented by reliable cost estimate for construction and related project costs. Underestimated construction cost principally do cause sincere problems such leading to the risk of project. There are mostly more than one reason for underestimating real project cost. The cost estimator may know constraint budget conditions, such trying to make his cost estimate fit into the public clients budget.

At the same time this may mislead him in recognition of specific cost influences. At the moment of bid opening this may result in coalition between the original cost estimate and the market response, such creating the risk of project failure.

In order to reduce the risk of unrealistic cost estimate it is recommended to investigate both the overall cost of comparable projects and to examine the cost composition of such comparable data. The evaluation of other cost estimate and respective construction culture should result in reliable figures whereas it is recommended to use the dynamic risk analysis approach as a link between cost estimate and bid price from the beginning via bidding until the end of construction.

#### 2. Overview of Construction Costs for Subway Lines

Construction cost of different international subway projects vary widely and imperative different contract policies, local conditions and therefore are not direct comparable. However a judicious overview of construction costs may be successfully used for estimations of new project costs when local influences and conditions can be taken into full account. In order to properly use collected information about cost data on different international subway projects, the discussion on the aspects and conditions of project development is required.

The data about construction costs of German subway projects are presented on fig.2., whereas different costs are showing average values for meter of subway line in Germany. It stays in the range of 40 000 – 55 000 USD. In comparison with other markets, e.g. USA, we may see that the level of prices for the similar subway project in Seattle from the time period July-November 2000 was far different. During the bidding procedure (that included : design, civil construction, mechanical, electrical and rail track works) two options have been negotiated with the Client for the 7675 m of the first subway line within fully publicly financed design-and-build procedure (Kolic 2000) :

- Double tube single track option with 3 deep stations and 1 cut-and-cover station for the price of : 110 000 USD/ m subway line
- Single tube double track option with adopted station configuration for the price of : 94 000 USD / m subway line

Beside difference in the overall price level for underground works in Europe and USA it should be noticed that the line in Seattle was deep located.

Overview of international subway projects presented in fig.1 shows that generalised average cost per meter of subway line. Different types of running tunnel constructions may be grouped per country. See examples 1 - 4 which show one rough overview of relation between TBM, NATM and Cut & Cover and station construction. There it can be concluded that TBM projects have higher unit costs than NATM projects. One reason is that initial TBM investments on relatively short lines and also more difficult geology have caused higher construction costs. On the other hand NATM projects have been performed with well trained staff and within geological conditions where application of NATM technology has been very well established and has numerous



referenced projects. Project in Singapore (example no.5) from the year 1996 shows that average cost level for comparable TBM project is somewhat higher in comparison with German average values but correspond to the cost on the Amsterdam subway line (example no.6). Examples from China (example no.7) and from Vienna (example no.8) show not more than average cost levels that are to be expected on underground markets in China and Austria. The value for example no.9 presents an average cost of a subway line in Munich. It should only be used as an isolated piece of information for further interpretation of construction costs.

Fig.1 Construction costs of international subway lines

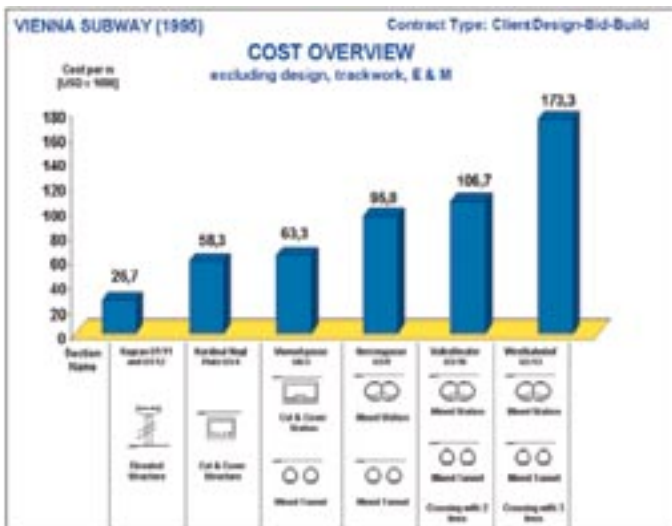

Fig.2 Construction costs of German subway lines.



Serious influence on higher US price have also American standards for civil works that require far more underground space and are increasing directly construction costs.

Fig.3. Construction costs of subway lines in Vienna.



An overview of construction costs on Vienna from the year 1995 are showing differences in construction costs from very simple elevated rail to highly complex and expensive underground station with tunnels section at the Western Railway Station. The price level for cut-and cover station structures with mined tunnels lays somewhere about 60 000 USD/ m and may be clearly differed from the price for mined station with mined tunnels (approximately 100 000 USD/ m line (fig.3)

The construction costs on Vienna subway system may be further used for discussion on levels of prices for underground works where it was to be expected that US prices should be higher than European. However, represented examples of con-

## 7. mednarodno posvetovanje o gradnji predorov in podzemnih prostorov

### TEMA 2 | NAČRTOVANJE KONSTRUKCIJ IN VZDRŽEVANJE PODZEMNIH PROSTOROV

struction costs for Vienna lines should always be considered investigating all local conditions and works that have been bringing together the final price.

The construction costs on Vienna subway system may be further used for discussion on levels of prices for underground works where it was to be expected that US prices should be higher than European. However, represented examples of construction costs for Vienna lines should always be considered investigating all local conditions and works that have been bringing together the final price.

The break-down of prices is next important step when using data from different constructed subway lines. Splitting of overall subway construction costs gives on overview about the price level of separate items, costs of labour work, costs of machinery and equipment used for the project and overall cost of materials. As shown on fig. 4 and 5 cost splitting is also showing which structures have been included in the construction of the subway line or its part and this way the structure of the project could be understand.

Example from Munich subway (fig.4) divides civil part of underground works of the structure from all other additional costs that are supporting underground works and, for this project have amount of about 37,7 %. Splitting of additional cost is showing that the major part is built by used equipment, labour costs and material.

Fig.4. Break-down of construction costs: Munich subway

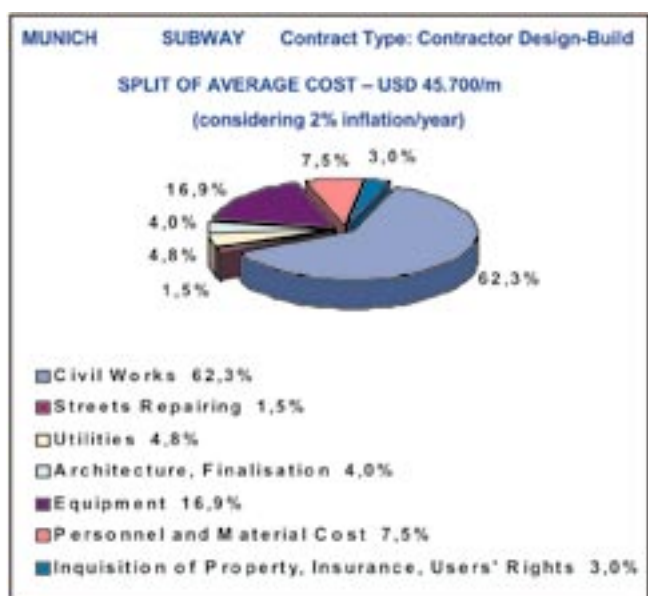
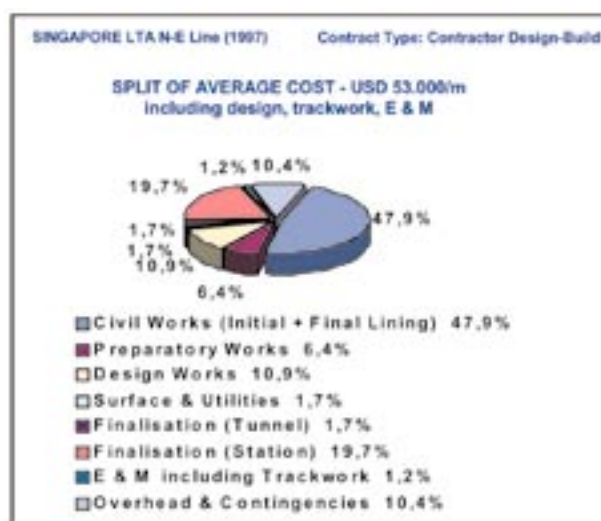

Fig.5. Break-down of construction costs: Singapore NEL.

The break-down of construction costs for the Contract 710 of North-East Line in Singapore shows division of costs on the type of works. It can be seen that the amount of additional cost items to the construction cost part is high : more than 20,3 % of overall construction costs is used for design works, overhead and contingencies. All represented examples are giving some information about average costs levels for different markets, works and price levels, but they can further use on other project will not be possible without taking in account local circumstances and other conditions.



### 3. PPP Approach

“Private-public partnership” (PPP) is a tried and tested way of delivering essential investment to a public sector, not a privatisation. The concept of public private partnership for rail infrastructure is not new. Most of the early rail projects in the USA in the 19<sup>th</sup> century were provided on a concession basis and the early lines of the London Underground were built by entrepreneurs who were supported by private investors.

The most significant benefits of the PPP come through transferring risk to the private sector. This means that should the project under the PPP overrun budget, the Government and taxpayers would not be left to pay the bill. Under the PPP, the private sector would bear the risk of additional costs. The Client (Government) should not have to fund any shortfalls. Especially when considering big infrastructure projects it is to be expected that the private sector is more efficient at managing the engineering projects and, combined with the activities of the public sector, they will produce substantially greater savings than alternative funding arrangements. This will also result in less borrowing overall than if money had been borrowed in the public sector. So the PPP will result in a lower level of Government borrowing and it should also achieve best value.

Therefore PPP approach would be essentially beneficial for investing in infrastructure projects bringing more investment, at predictable levels, for the long terms. Experiences of application of PPP scheme in UK in last years are showing on average, efficiency savings of 17% compared with the public sector alternative. Without PPP scheme several major infrastructure projects in UK would remain promises, not actual projects, like e.g. : UK National Air Traffic Services Project, Channel Tunnel Rail Link, Docklands Light Railway System, modern tram schemes along the UK etc.

### 4. Example 1: London Underground (Jubilee Line)

London Underground is responsible for running the world’s oldest underground railway and one of the largest. The Underground serves over 275 stations, running trains over around 400 km of track, on 12 different lines, although only 42% is in tunnels. Around 2.6 million passenger journeys are made each week day totalling to around 866 million passenger journeys per year. London Underground is part of London Transport, a nationalised industry which is owned by the Government and has suffered from chronic underinvestment (fig.6).

In March 1998 was announced that the Government would be introducing a public-private partnership (PPP) to bring stable, increased investment into London Underground. The plans involved are dividing London Underground into a publicly-owned operating company responsible for delivering services to customers, and three privately owned infrastructure companies. The objectives were to deliver 8 billion GBP worth of investment in London Underground over the next 15 years (fig.7), to maintain and upgrade the infrastructure, improving services for passengers and providing value for money for the taxpayer.

The Underground PPP will mean train and station services continuing to be planned and operated by a publicly owned, publicly accountable London Underground. LU will be responsible for safety on the whole of the Underground and will remain as the single guiding mind of safety matters. Private companies have been

Fig. 6 Chronic underinvestment in underground from 1970-1999 and “steady-state” requirement line.

Fig.7 PPP yearly investments for next 30 years.

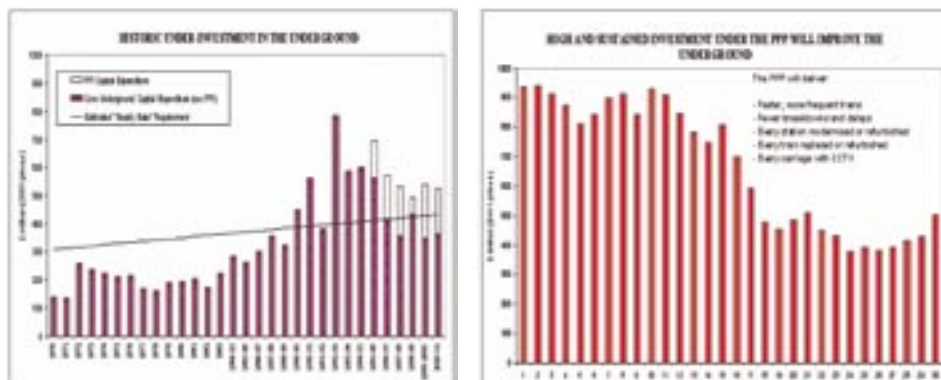

invited to bid for the responsibility to maintain and upgrade the track, tunnels, signals, stations, lifts, escalators and trains under contract to London Underground. The contracts will include rigorous performance criteria, and will be for a limited period only, after which the upgraded assets will return to the public sector.

The line groupings that have been offered to the private sector are :

- Sub-surface (Circle, District, Metropolitan, East London and Hammersmith and City lines)
- BCV (Bakerloo, Central, Waterloo and City, and Victoria lines)
- JNP (Jubilee, Northern and Piccadilly lines)

The BCV and JNP groups are known together as the “deep tube “ lines because the tunnels on these lines are smaller, running through tunnels bored deeper under the centre of London. The sub-surface lines are only just below ground level, having been built in “cut and cover” tunnels.

Any deals will have to meet several important criteria including a strong commitment to enhance the safety of the network for passengers and staff, and a commitment to work in a partnership with the public sector to deliver improved services to passengers. The private sector will be allowed to achieve profits in return for improved performance and improved services for passengers.

Two bidders were shortlisted in July 2000 for each of the two deep-tube lines and detailed negotiations took the place afterwards. Separately the option to integrate the national railway network in the sub-surface lines have been explored. The practicable scheme has not been found that would deliver acceptable integration. Therefore London Transport was running a new competition for the sub-surface lines in parallel with those for the deep-tube lines : bids have been received in September 2000 (DETR, 2001a).

In order to able to handle and compare all possible offers and compare them with the requirements of the Client, one scheme called “Public Sector Comparator” (PSC) has been established and its methodology opened for all bidders. A PSC has been developed in order to establish whether the PPP does indeed represent better value. It should show the overall cost of raising finance and actually doing the work under a wholly public sector arrangement. Bids would need to show that the PPP will represent better value. The comparator itself will be published once it is clear that it would not prejudice the negotiating process by showing bidders the assessment of the capabilities of the public sector.

A PSC is an estimate of the cost to the public sector of procuring a service on the assumption that this is done through the public sector funding and that the public sector retains managerial responsibility and significant exposure to risk. The PSC needs to address the different factors which will determine whether a wholly public sector option or PPP will give best value to the public sector over time. The most important factors are :

- The “Retained Risk” which, by its nature, always rest by the public sector. An example is the London Underground PPP where the risk of fare revenue falling below its expected level.
- The “Base Cost” of providing services required by the public sector. For LU this is principally the public’s sector estimate of what it will spend to enhance, maintain and manage the infrastructure over 30 years in accordance with the performance. The “Base Cost “ projections have been prepared in four categories : major investment costs, steady-state investment costs, maintenance costs and other infrastructure company costs as e.g. management and overhead costs of the new businesses.
- The “Risk Adjustment” of the base cost figures, to reflect the probability that service will not be delivered at the cost shown in the base cost projection because of events like cost overruns or technical problems, or that the budgets may be maintained but at the expense of reductions in service quality. The value of such risk estimations has very often not been taken into consideration in past public sector estimations.

The PSC consists of cashflow projection which takes account of all these factors and will be compared to the private sector’s PPP bids. The PPP bids will show the price to which the private sector is willing to commit for providing the same services. This will include the bidder’s assessment of what price they need to take over certain risks from LU under the PPP contract. The public sector will add to this price the value of retained risks in order to make an overall comparison between the public and the PPP options.

Special attention within PSC has been payed on procedures of risk analysis regarding financial aspects of the project. Following the procedures for risk analysis identification and categorisation of risks have been stated : risk register has been prepared to identify and categorise the main project risks according to their allocation under the PSC and the PPP, risks have been prioritised and quantified and the risk analysis has modelled the expected financial impact of the risks over a 30 year period (DETR , 2001b).

The risks identified in the risk register fall into the following main categories :

- Demand and revenue risks (as e.g. availability of services and related assets, failure to meet required “scheduled-journey-time-capability”, poor ambience of trains and stations)
- Operating and maintenance risks (as e.g.: cost of operations, availability of staff, spares and consumables, fire, theft accidental damage and vandalism to the

extent that these cannot be covered by insurance, commissioning new infrastructure and equipment and integrating it into existing system)

- Design and construction risks (principally failure to deliver enhanced assets as required by the performance specification due to : poor or inadequate design, design errors, late changes to design or the late delivery of completed design, implementation risks such as site access problems, unforeseen ground conditions, weather, or archaeological discoveries, interferences from other parties, cost overruns)
- Other risks (such as : availability and cost of finance, changes in law, taxation, general inflation etc.).

Mentioned risks are being prioritised and quantified. The data source for quantifying them is mainly LU experience from previous, for example on costs diverging from expectations. Due to the relative values of comparators for managing the infrastructure of an underground railway of this age it is not considered that there is much scope for using historic data from other sources. However, it has been taken into account that the risks are fully and appropriately quantified, without either managerial bias towards optimism or an automatic assumption that any past shortcomings in managing risk will continue. In particular : quantification of risks has been cross-checked from independent interdisciplinary experienced estimators, financial experts have to question the management to test whether the financial risk quantification can be regarded as financially robust for this purpose. Where risks could be mitigated by insurance (for example the risk of fire) LU will consider the insurance premium which could be obtained from the market.

The risk analysis has taken measures to avoid double counting of risks and took into account any correlation between them. For example :

- if the quantification of potential cost overruns partly reflects the possibility of increased staff costs then there should be no separate allowances for differential wage increases over and above inflation
- it will be estimated that there is a correlation between unforeseen ground condition costs and the risk of contractual claims etc.

Further considerations of financial risk assessments has introduced e.g. the provision of Periodic Reviews for the terms every 7-8 years to give LU the opportunity to restate its performance requirements and allow the private partners to revise charges to reflect the fair level of payments. While the PSC is a 30 year projection of the public sector's costs which can be compared to the private sector's projections in their bids, allowance will therefore be made for the fact that the private sector is not taking full cost risk over the 30 year term. Some of the risk of cost changes after year 7 or 8 remain with the public sector as a retained risk in both the PSC and PPP option.

#### 5. Example 2: Dublin Metro

The Government of Ireland decided in principle in July 2000 that a Metro should be developed in Dublin on a PPP basis and that the Light Rail Project Office should commence the initial work necessary with a view to bringing the project to the market. In September 2000, the Dublin Transportation Office(DTO) presented its strategy doc-

ument “A Platform to Change” to the Government- This document places the Metro in a wider public transport network to be developed over the next decade (DPE, 2002).

Taking into account proposed phasing in DTO’s “Platform for Change”, the initial proposal suggests that the Metro project will be broken into a number of stages, to be largely implemented between 2004 and 2010. The first stage could see a route developed between the City Centre and the Airport with the extension to Blanchardstown and Sports Campus Ireland (23.7 km)(fig.8). Later works might include further extensions within the city area and from the Airport northwards.

Methods of construction have been roughly investigated, but a mixture of surface alignment, cut-and-cover, bored tunnel and some elevated structure in less dense areas is thought likely. Transport planning data suggests that each of the Metro branches might offer a service every 3 to 6 minutes, with the City Centre alignment possibly carrying a service as frequently as every 90 seconds. In this regard, the optimal design of the system and the interchange stations within it will be crucial to a successful operation.

Fig.8 City plan of Dublin with Metro Phase 1, underground and surface part of the line.



Stations would be probably set between 700 meters and 1 km apart, in general, although the use of high performance rolling stock would allow somewhat closer spacing if necessary, within specific areas such as the City Centre. The need to moderate construction costs and to advantage of flexibility of alignments, and the need to integrate LUAS network, means that the Client considers that a technical approach to the Metro which uses modern LRT style rolling-stock and the attendant gradients and curvatures possible, might provide an appropriate solution to Metro implementation.

As PPP transactions can take a number of forms to reflect the roles and responsibilities of the various parties and the contractual relationships between them. These structures have evolved to

ensure that the agreed allocation of risks is allocated in the agreements executed by the parties. In the case of Dublin Metro project they are likely to stay in following categories :

- “Operate Agreement” (there require private partners to provide services for the day-to-day operation of the trains and infrastructure e.g. signaling, and (in addition to any actual operation of the train service) may include maintenance services
- “Design, Build & Operate” (these structures will be appropriate where private partners contract to design and construct new infrastructure, which is then operated by them. Financing is provided from Exchequer resources.
- “Design, Build, Finance & Maintain” (such structures will be adopted where separation of responsibility for provision of infrastructure and operation of trains is

appropriate. Maintenance responsibilities in respect of the infrastructure may be included. This approach will facilitate separate Operate agreements as the network is rolled out.

- “Design, Build, Finance & Operate” (under these arrangements full responsibility is allocated to the private partner to deliver the infrastructure and operate the trains over an agreed period of time.

Which form of PPP category will be used is let to the bidders, but even though it not defined which category will be used it is stated what is expected as result :

- shared responsibility for the provision of the infrastructure and/or services with a significant level of risk being taken by the private sector
- long term commitment by the public sector to the provision of quality public services through arrangements with private sector operators
- better value for money for the Owner and Users and optimal allocation of risks

In comparison with the London Underground PPP schemes where the client prepared a “Public Sector Comparator” (PSC), Dublin Railway Procurement Agency has established a valuable tool in assessing the potential of PPPs to deliver value for money in the form of “Value for Money Comparator” (VMC). The VMC is the benchmark against which bids from private partners can be assessed. An important component of the VMC is the value attributed to retained and transferred risks, as these must be carefully quantified if comparison on a like for like basis is to be achieved.

The allocation of risks between the parties to a PPP transaction is also fundamental to making sure that only bankable projects are brought to the market if private investment is to be secured. Prior to introduction to the market the project will be subjected to rigorous risk assessments within own risk profile. Therefore one risk management methodology has been established consisting of following steps :

- Establish objectives and risk appetite
- Risk identification, classification and allocation
- Assessment, impact and quantification
- Identify mitigation procedures
- Prepare or update risk register

The purpose of this approach is to ensure that no risks are overlooked, and that all identified risks are monitored and managed in order to minimize potential adverse impacts. Identification of risk will be continuous activity throughout the development of PPP project. A starting point was to establish the broad categories within which risks will be analyzed and to define their allocations as shown in tab.1.

While the risk allocation outlined in table 1 is recommended to RPA, it is sure that the finding of final risk allocations is an iterative process through which initial positions will change as a result of actual experience and interaction with private partners throughout the tendering and/or negotiating processes on specific projects. The structuring of light rail and metro PPP transactions will be heavily influenced by models which have been adopted for large scale project financing transactions. The



Tab. 1 Risk allocation matrix.

Risk category	RPA	Private Partners	Shared
Land acquisition	*		
Railway order			*
Utilities			*
Design, Construction, Supply		*	
Commissioning, Operating, Mainten.		*	
Demand			*
Residual value		*	
Technology and obsolence		*	
Regulatory, Legislative		*	
Environment		*	
Financial		*	
Safety		*	

primary commercial and financial objectives will relate to:

- PPP structures : clear responsibility for the ownership and management of risks
- Funding : no preference on funding structure, the exact nature of funding will depend on specific project risks.
- Revenue : to transfer revenue risk where it is appropriate and provides value for money for public sector. Collection and management of revenues should be the responsibility of the private sector.
- Payment and performance : payment mechanism and performance should complement each other
- Risk : preferred position on risk allocation is shown in table 1.

## 6. Zagreb Light Rail Concept

More than 30 years has passed since first serious ideas about development of some capable urban transport system in the city of Zagreb has been presented. Different opinions varied among simple improvement of the existing urban system (tramway, bus, rail) toward very potential and capable ideas for the application of the metro system as the best and only correct solution.

In the meantime requirements for urban transport increased dramatically in last 15 years in Zagreb, having as a result decreased living and working conditions in urban area.

At the same time the amount of urban transport travels in the entire daily travels decreased from 65% to 45%. At the same time the amount of personal vehicles increased to 330 000 that in comparison with the amount of Zagreb inhabitants (800 000) shows high motorisation level of the area.

„The Zagreb Urban Transport Study“ has been finished as the result of collaboration of british, german and croatian experts at the end of 1999. Different investigations and simulations using various traffic models have been performed taking into account special aspects of Zagreb city, and the conclusion of the study was that the optimal solution should be the implementation of the light rail system consisting of 4 new lines. New lines have to be placed underground in the old town city parts, providing required average travel speed of 30-40 km/h in

comparison with the present tramway speed of 5-10 km/h.

Future years will be used for the development of light rail system of Zagreb through several different activities starting with basic project decisions and design steps toward construction and operation.

#### 7. Conclusions

In summary the PPP model for financing of subway systems is recommended based on the following reasons:

- in order to provide appropriate project financing a PPP project development is recommended transferring risk from the public to the private sector
- in order to provide appropriate cost estimate it is recommended to analyse comparable projects as adapted to local circumstances and to link it with respective risk analysis
- in order to provide appropriate reliability of project cost it is recommended to implement a dynamic risk and cost management throughout the life time of the project

#### References

- 1) M. Irshad (1999): "Hierarchal Cost Modelling and Financial Risk Management for long Rail and Road Tunnels" Long Road And Rail Tunnels 1<sup>st</sup> International Conference, Basel Switzerland, November, 1999.
- 2) D.Kolic (2000): "Estimation of construction costs for subway lines", 5<sup>th</sup> International Symposium on tunnel construction and underground structures, Ljubljana, September 20-22, 2000, pp.38-46
- 3) DETR (2001a): "The government's plan for a public-private partnership for London Underground", pp.5, DETR, updated March 12,2001, access on : April 17,2001, <http://www.railways.detr.gov.uk/underground>.
- 4) DETR (2001b) : "London Underground Public-Private Partnership : Methodology for Preparing the Public Sector Comparator", pp.17, updated March 12,2001, April 17,2001, <http://www.railways.detr.gov.uk/underground/>
- 5) DPE (2002) : "Rail Public Private Partnerships – Policy Framework : Metro Dublin", Department of Public Enterprise, pp.245, February 2002

## Highway Tunnels in Slovakia

Assoc. Prof., Ing. Juraj Ďurove<sup>1</sup>, PhD., Assoc. Prof., Ing. Koloman Ratkovský, PhD.<sup>2</sup>,  
Dipl.-Ing. Štefan Choma<sup>2</sup>, Dipl.-Ing. Pavol Vavrek, PhD.<sup>1</sup>

<sup>1</sup> Technical University of Košice, Faculty BERG, Dept. of Mining and Geotechnics,  
Letná Str. 9, 040 01 Košice, Slovak Republic, e-mail:juraj.durove@tuke.sk

<sup>2</sup> Slovak Road Administration, Miletičova Str. 19, 826 19 Bratislava,  
Slovak Republic, phone: +421 2 5025 5111, www.ssc.sk

State transport policy in the Slovak Republic required applying new principles and approaches to the development of all road infrastructures. The TINA Project on the territory of Slovakia consists of multimodal and complementary network. One of the Trans-European multimodal transport corridors in the territory of Slovakia is the motorway (highway) D1: from Bratislava – Trenčín – Žilina – Prešov - Košice to the state border of SK/Ukraine with more than 30 km length in summation of the highway tunnels, all running across the West Carpathians Mountains. The first tube of the almost 5 km long Branisko Tunnel went into service on June 29<sup>th</sup>, 2003 and next – the Tunnel Horelica – will be in operation in the end of this year. The Branisko Tunnel was successfully driven by using the New Austrian Tunnelling Method. The aim of this article is to inform of the present state of highway tunnels in the Slovak Republic.

**Keywords:** tunnels – road infrastructures - the Slovak Republic

### Introduction

As for geography Slovakia is bordered by the Czech Republic in the west, by Poland in the north, by Ukraine in the east and by Hungary and Austria in the south (Fig. 1). The borders are mostly natural, made by rivers (the Danube, the Morava) and West-Carpathians Mountains.

New economic and political conditions, especially the formation of the independent Slovak Republic (on January 1, 1993), required defining and applying new principles and approaches to proportional and structurally balanced development of all transport branches. The state policy in the field of road infrastructure is defined in the “Principles of State Transport Policy of the Slovak Republic” [1]. The increase of co-operation between countries in the European Union has stressed the strategic importance of transport in mutual relations. The free movement of people and the exchange of goods are two main signs for the positive synergic future development in our regions.

### Motorways (Highways) and Expressways

The part sections of the Slovakian motorway network already operational belong to the first category of the European highways network. Apart from a number of shorter access routes, the planned motorway network in the Slovak Republic will have three main arteries (Table 1) at its disposal [2]. These are:

## 7. mednarodno posvetovanje o gradnji predorov in podzemnih prostorov

### TEMA 2 | NAČRTOVANJE KONSTRUKCIJ IN VZDRŽEVANJE PODZEMNIH PROSTOROV

- D1 Motorway: it leads from west to east, i.e. from Bratislava via Trenčín, Žilina, Poprad, Prešov, Košice up to the border between Slovakia and Ukraine and is altogether 517 km long. This is the longest motorway route in Slovakia and the majority of the tunnels are to be found along the D1.
- D2 Motorway: it runs in a north-south direction from Brno via Czech – Slovakian boundary to Bratislava and from there over the Danube River to Hungary. In a north-west direction from Bratislava is under construction the Sitina Tunnel.
- D3 Motorway: this route largely runs in a north-eastern direction as a connection to Poland. Here from Hričovské Podhradie via Čadca to Zwardon in Poland are located more tunnels (Horelica, Svrčinovce, Kysuca, Poľana).

Fig. 1: Tunnels on the motorway network in the Slovak Republic

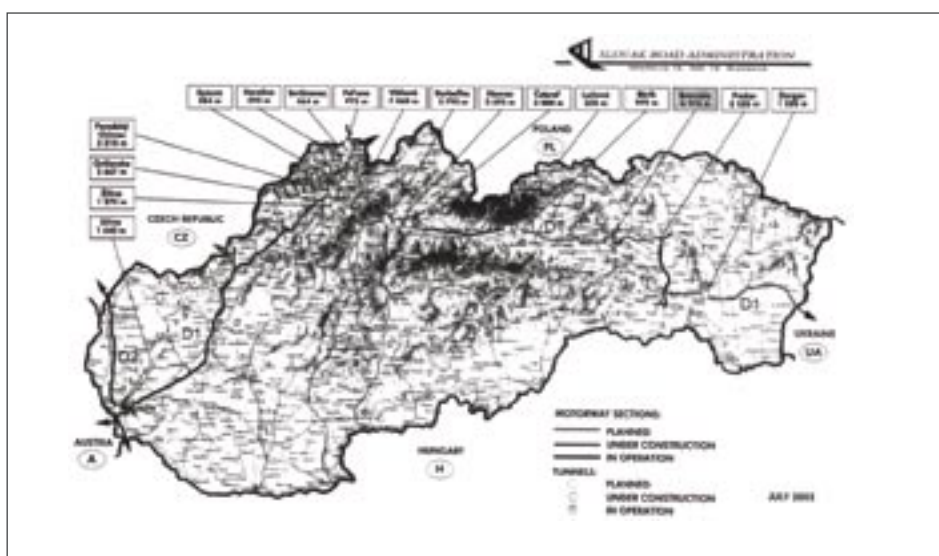

Table 1: Planned tunnels in the Slovak Republic

Motorway	Motorway section	Name of tunnel	Length [m]
D-1	Hričovské Podhradie – Lietavská Lúčka	Ovčiarisko	2 667
		Brezovec	338
		Hôrky	190
		Žilina	1 370
	Višňové – Dubná Skala	Višňové	7 460
	Turany – Hubová	Korbelka	5 795
	Hubová – Ivachnová	Havran	2 695
	Vážec – Mengusovce	Čebrať	2 080
Mengusovce – Jánovce	Lučivná	250	
Mengusovce – Jánovce	Bôrik	999	
Beharovce – Branisko	Branisko	4 975	
Prešov west – Prešov south	Prešov	220	
Bidovce – Dargov	Dargov	1 050	
D-2	Bratislava, Lamačská cesta – Staré grunty	Sitina	1 440
D-3 (D-18)	Hričovské Podhradie – Kysucké Nové Mesto		
	I. constructed section Hričovské Podhradie – Žilina (Strážov)		
	II. constructed section, part I. Žilina (Strážov) – Brodno	Považský Chlmec	2 218
	II. constructed section, part II. Brodno-Kysucké Nové Mesto	Kysuca	584
	Čadca Tangenta – I. stage	Horelica	605
Svrčinovec – Skalité	Svrčinovec	464	
	Poľana	975	
Total length:			36 375

### Essential parameters of the Branisko tunnel

One of the most challenging stretches of the D1 Motorway was the passageway through the Branisko mountain range in the east of Slovakia, which represents a natural 7km-long obstacle where major traffic accidents were common, often leading to the blockage of the only connection traversing the region, the state road I/18. It was therefore this part – the D1 motorway stretch Beharovce – Branisko that was to be addressed foremost as a separate construction by the building of a tunnel.

As a part of the D1 Motorway Bratislava – Košice, the D1 Motorway stretch Beharovce – Branisko, which also includes the Branisko Tunnel, starts in the cadastral locality of Beharovce (370.474 km from Bratislava) and ends by linking up to the relocated state road I/18 – the Široké bypass (378.240 km from Bratislava). The constructed section is 7,766 m in length. Road class: D26,5/100.

Putting the Motorway Beharovce – Branisko into operation with a tunnel through the Branisko mountain range at the same time as the D1 Fričovce bypass represents, together with the already existing Široké bypass, a comprehensive D1 Motorway section in East Slovakia, 15.1 km in length from the Beharovce to the Fričovce junction. Operation of this motorway section has eased traffic along dangerous sections in the villages of Korytné, Široké and Fričovce and has also made it possible to avoid the most dangerous traffic obstacle on the D1 Motorway, i.e. the Branisko mountain pass. Hence, the Slovak traffic infrastructure is making great progress in achieving its goals to attain a European standard, integrate our road network with the networks in neighbouring countries as part of the 'Va' corridor, and especially to ensure comprehensive traffic access to the territory in line with national, economic, social and demographic development plans.

The successful completion of such a unique work as the Branisko Tunnel, the first of its kind in technical terms in the Slovak Republic, is an excellent credential of the expertise and technical knowledge of Slovak design and construction companies, technology suppliers, construction investment planning, as well as successful co-operation with specialists from the Czech Republic, Switzerland, Austria and other countries.

Thanks to the continual interest and support of the Slovak Government, ministries and responsible civil servants, putting the Branisko Tunnel, the first motorway tunnel in the Slovak Republic, into operation in 2003 was made possible.

In terms of design and realisation, the construction of the D1 Motorway Beharovce – Branisko was divided into the following phases:

#### Phase I.: Right tunnel - construction

- terrain preparation for the West and East Portals,
- disposal areas and associated access roads,
- construction of the right (south) tunnel tube.

#### Phase II.: Right tunnel – equipment and portals

Construction part:

- associated portal elements near the West and East Portals,
- associated exhaust premises and ventilation engine room near the ventilation shaft,
- ventilation shaft,

- ventilation and traffic connection between the ventilation shaft and escape corridor,
- carriageway and footpaths in the tunnel,
- escape corridor,
- water management elements near the Portals and associated exhaust premises,
- high-voltage connection near the West and East Portals and in the associated exhaust premises above the ventilation shaft.

Technological part:

- tunnel power supply,
- ventilation equipment for ventilating the tunnel, power units and the escape corridor,
- tunnel safety equipment,
- Central Management System,
- tunnel lighting and escape corridor,
- electronic fire detection system,
- traffic signalling,
- measurement of physical variables,
- Operator workstation at the Motorway Management and Maintenance Centre in Beharovce for both the motorway and the tunnel,
- technological equipment in the escape corridor.

#### **Phase III.: Motorway, roads, bridges, motorway management and maintenance centre**

- access points of the D1 Motorway Beharovce – Branisko, from the beginning of the section in Beharovce to the West Portal at half profile (length: 2,431 m + junction 237 m),
- motorway bridges: 3 bridges between Beharovce and the West Portal (Korytné) at half profile, access road from the state road I/18 at half profile,
- junction with the state road I/18 in Beharovce,
- Motorway Management and Maintenance Centre in Beharovce,
- water treatment plant at Granč-Petrovce.

#### **Phase III.a: Motorway**

The motorway between the East Portal of the Branisko Tunnel and the already operational Široké bypass at full profile (360 m in length), including the completion of the information system and technological equipment of the bypass around the village of Široké.

The Fričovce bypass has been constructed at full width, as applicable to motorway class D26,5/100. It is 3,207 m in length (plus the junction of Fričovce of 821 m). Phase III.a also included the installation of the motorway information system and technological equipment. The bypass also includes 5 bridges with overall length of 659 m and 321 m of supporting walls at sections with unstable terrain. The relocated state road I/18, Široké bypass, is 3,061 in length.

The construction of the Branisko Tunnel was preceded by a detailed engineering-

geological and hydro-geological survey (April 1996 – Dec. 1977), which was conducted by means of an exploratory drift of 4,841 m, located in the route of the future left (north) tunnel tube. The exploratory drift was adapted in such a way that it currently functions as an escape corridor for people in the case of fire or other emergencies in the tunnel, as well as for other safety and operational purposes.

Table 2: Basic specification of the Branisko tunnel – right (south) tube

Length of driven tunnel	4,822.030 m
Traffic length of tunnel	4,974.626 m (including both Portals)
Longitudinal gradient	+ 1.20 % inclining from the west for 4,550 m - 1.65 % declining for 425 m
Cross fall throughout the tunnel	2.5 %
Stope cross-section area	82 – 103 square meters (standard profile)
Traffic cross-section area	47.68 square meters
Ventilation channel cross-section area	13.97 square meters
Width clearance	9.5 m
Carriageway between curbs in the tunnel	7.5 m
Footpaths with	2 x 1.0 m
The length of carriageway in the tunnel, including the Portals	4,975.0 + 30.0 m
Carriageway area	35,126.0 m <sup>2</sup>
Carriageway, material used	cement concrete
Maximum speed in the tunnel	80 km per hour
Traffic height of the tunnel	4.5 m + 0.1 m
Total height clearance	7.319 m
Height clearance above the footpaths	2.2 m
Number of emergency bays: 6 – incl.	4 one-sided 2 double-sided Distance between bays – 720 m Emergency bay lane width – 3.0 m
Total area of the carriageway in emergency bays	960.0 square meters
Number of escape routes	13; 360 m apart
Number of SOS niches	16 + 6; 240 m apart (situated on the right-hand side of the tunnel)
Number of SOS boxes	41 units; 120 m apart on the left-hand side
Tunnelling method	New Austrian Tunnelling Method (NATM)

### Performance and headway during excavation

- maximum daily headway on one face: 9.0 m
- average monthly headway on both faces: 190 m
- maximum headway per month in several consequent months on both faces: 240 – 300 m

### Key dates

- start of construction: May 1997
- breaking through the tunnel: 01 May 1999
- Launch of tunnel into operation: July 2003

All technological equipment ensuring the correct functioning of the Branisko tunnel complies with safety requirements under normal operating conditions, without limitations, as well as in the case of emergency incidents. The technological equipment allows the timely and precise warning of all persons about the occurrence of an emergency situation as well as about necessary procedures to be taken, and where required also allows the swift and safe evacuation of all persons from the tunnel.

The tunnel ventilation system has been dealt with such that fresh air is sucked into the tunnel tube by axial fans mounted in the Portals, while spent air is discharged from the tunnel through the ventilation shaft issuing from the surface. The operation of the extraction fans in the exhaust premises located above the ventilation shaft is guaranteed for 90 minutes at a temperature of 250°C. The escape corridor, connected to the tunnel tube through 13 transverse escape galleries, has its own autonomous ventilation system, which stops spent air or fire smoke and fumes from flowing into the escape galleries and the escape corridor. The escape galleries are equipped with fireproof doors with resistance for 90 minutes.

**The tunnel is equipped with the following security equipment:**

**SOS boxes** serve tunnel users and allow them to contact tunnel control staff in an emergency and report a problem that has occurred or to request help in the simplest possible way. SOS boxes are installed in niches and emergency bays, 240 m apart. Should voice communication be rendered impossible, users may press the SOS push button to call for help. In addition to communication means, each SOS box also contains a first-aid kit and fire-fighting equipment.

**Closed-circuit television (CCTV)** provides the tunnel control staff with visual supervision of traffic in the tunnel and allows them to quickly respond to emergency situations. The CCTV, comprising 79 cameras, is also complemented by the AUTOSCOPE system, which evaluates the video data from the cameras in the tunnel. The system automatically detects any violation of traffic rules such as a vehicle moving in the opposite direction for instance, or a vehicle stoppage, overtaking, leaving a traffic lane, traffic jams, or speeding.

**Wireless radio** connection, the key function of which is to transmit radio signals between the tunnel and its control staff, has been supplemented with a connection between the control room and the tunnel manager's service networks, emergency announcements via UHF radio broadcasting, and digital recording facility. The tunnel is also equipped with a system allowing GSM telephone signals of both Slovak operators.

All technical equipment in the tunnel is managed and controlled by the Central Control System (CCS), which integrates all functions of equipment regulating the traffic flow in the tunnel and adjacent motorways. The Tunnel Control Room is located in the Motorway Management and Maintenance Centre (MMMC) in Beharovce and in the ancillary control centre at the West Portal, from where it is possible to provisionally monitor and control the traffic in the tunnel. Operation of vital technological equipment and its parameters (e.g. ventilation equipment, lighting intensity, etc.) is optimised in terms of tunnel safety by means of the system measuring physical variables.

**Tunnel traffic** is fully controlled by the Central Control System, where the operator can choose one of 18 operational plans. In an emergency the traffic flow in the tunnel is either automatically diverted or stopped, while the plans applied to adjacent motorway sections at the junctions Beharovce – Fričovce are automatically adjusted accordingly.



**Electric power** is supplied to the Branisko Tunnel from two independent sources via 22 kV lines from high voltage substations in Prešov and Krompachy. In the case of a breakdown of any of the power sources, the control system automatically switches to back-up sources of technological equipment so that there is no blackout. Selected technological equipment, e.g., fire lights, adjustable traffic signs, fire louvers and SOS boxes, is connected to back-up power supply by means of UPS units, which have been dimensioned such that they keep the tunnel operational for 120 minutes.

The Branisko Tunnel has been constructed and equipped such that it complies with new European standards concerning traffic safety in tunnels. Nevertheless, a vital prerequisite for securing safe tunnel operation will be the proper conduct of tunnel users and their respecting of traffic rules, traffic signs and signalisation.

**Construction of the Sitina Tunnel**

The tunnel will consists of two tunnel tubes, each with two traffic lanes. The Tunnel will be furnished with modern technology, which will control the operation of the tunnel, ventilation, lighting, traffic and tunnel closure in the case of jams or accidents. The control will be either automatic or manual from the Control Centre and the subsidiary dispatching centre. In addition the tunnel will be furnished for events of accidents (SOS niches, fire water main, and escape corridors).

**Tunnel Sitina technical parameters**

Length [km]	Covered part	Cut and covered part	Driving part	Total length
Eastern tube	0,216	0,040	1,159	1,415
Western tube	0,206	0,050	1,184	1,440

Area of cross-section clearance	59,00 m <sup>2</sup>
Area of passing clearance	42,35 m <sup>2</sup>
Area of theoretic excavation	79,54 81,77 m <sup>2</sup>
Area with invert	92,13 93,26 m <sup>2</sup>
Vertical clearance	4,8 + 0,10 = 4,90 m

**Tunnel construction**

The tunnel will be constructed by the New Austrian Tunnelling Method (NATM).

To protect the surrounding structures and citizens against tunnelling operations, seismic monitoring will be performed as an essential part of works. It will consist of initial monitoring performed before the start of blasting and of the monitoring, which will be performed simultaneously with blasting.

Before the commencement of works all structures in vicinity of the construction will be examined for any existing structural damage. Blasting will be only performed during specified hours (not in the night). The impact of blasting to structures will be continuously examined and the charges size will be modified according to the monitoring results.

The tunnel construction will be difficult from the geological view, because approxi-

mately 1/3 of the driving part is in disturbed zones and the tunnel has a relatively small overburden (Fig. 2).

### Construction description

Bratislava is located at the intersection of important traffic routs that include motorways, roads, railways, air traffic and an inland waterway with an important harbour. The construction of the D2 motorway Bratislava, Lamačská cesta – Staré grunty is the last missing section of D2 motorway and its completion will link the Czech Republic through Bratislava to the Hungarian Republic. Traffic is obliged until now to use the Lamačská road and Mlynská dolina, which are the most heavily trafficked roads in the city.

The section of D2 motorway to be constructed is 3.300 km in length, of which the Sitina Tunnel is approximately half the length.

Together with the motorway construction, all road structures in this part of the town will be rebuilt. Construction requires relocation of parts of Lamačská road, Harmincova Street, road Mlynská dolina, extension of Saratovská road and connection of Dúbravská road and Polianky.

In the Lamač section there will be a junction for the D2 motorway with roads Lamčská and Harmincova in all directions except the direction Dúbravka Brno and back. This direction will be realised on the extension of Saratovská road. In the Mlynská dolina section there exist a junction with ramps to all directions.

Fig. 2: Geological longitudinal profile

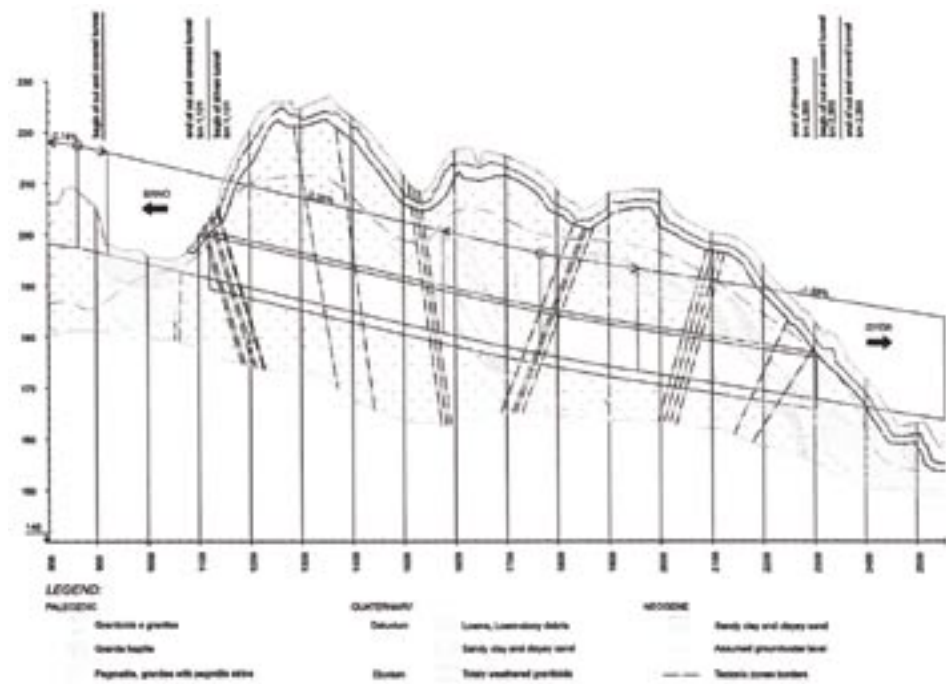
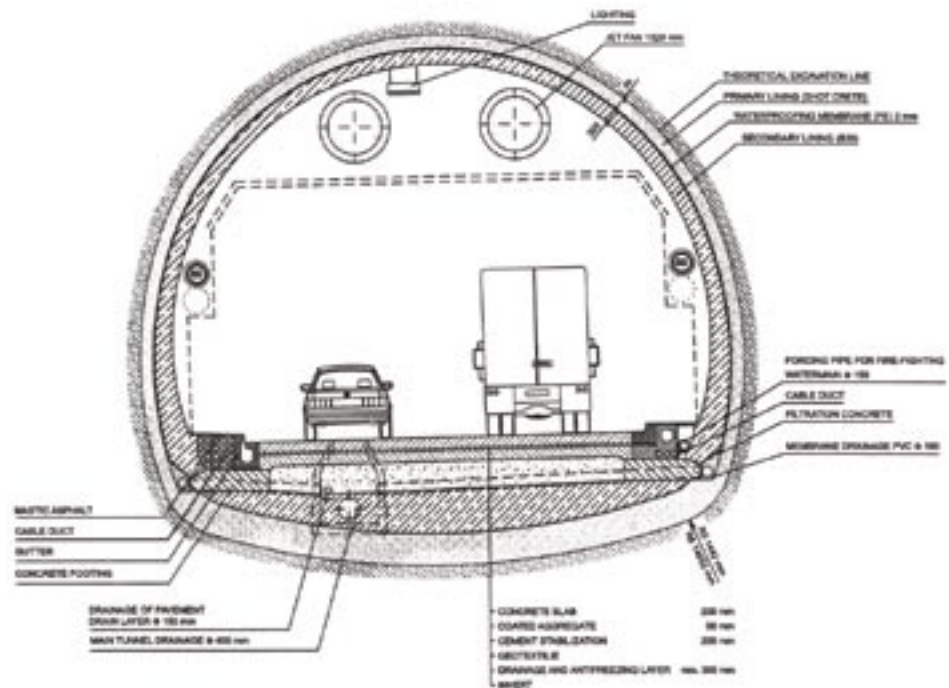

Fig. 3: Tunnel Sitina. Typical cross section with invert (one tube)



After putting into operation the transit traffic (motorway) and the urban traffic will be separated. Transit traffic by passing the town will be eased. The junctions D2 with Lamačská road (Harmincova) and Mlynská dolina will also allow better use of the motorway for the urban traffic. (Fig. 3.)

#### Other construction structures

The construction is divided into 216 structures. From the structures there are 2 motorways, 12 roads, 10 bridges, 3 river regulations, 16 civil and 15 technological structures on the tunnel, 39 pipe utilities, 43 heavy current lines, 34 telecommunications lines, 1 new ZOO entrance. Others are small and auxiliary structures.

#### Conclusion

The road network including motorway tunnels in Slovakia are, as far their density and technical standard, comparable to those of other European countries. At present are in the Slovak Republic 302 km of motorway and 52 km of expressways in operation. For near future the total network with tunnels is shown on Fig. 3.

#### References

- [1] Resolution of the Government SR No. 21 of January, the 12<sup>th</sup> 2001
- [2] Choma, Š., Ratkovský, K.: First Motorway Tunnel opened in the Slovakian Republic. Tunnel, Off. I. of the STUVA, 2/2004, 25-34
- [3] Information Bulletin of Slovak Road Administration. SSC, Bratislava 2003
- [4] Hatala, J., Ďurove, J., Maras, M., Vavrek, P., Vrabec, F., Jesenský, O.: Diaľnica D1 Behárovce – Branisko. Správa z aplikovaného výskumu využitia hornín z tunela Branisko, k Dokumentácii pre stavebné povolenie. KDaG, Fakulta BERG TU v Košiciach, 1997

## New high-speed railway lines Stuttgart 21 and Wendingen-Ulm - Approximately 100 km of tunnels

Prof. Dr.-Ing. W. Wittke

WBI – Prof. Dr.-Ing. W. Wittke Consulting Engineers for Tunneling and Geotechnical Engineering Ltd., Aachen/Stuttgart, Germany

Dr.-Ing. C. Erichsen

WBI – Prof. Dr.-Ing. W. Wittke Consulting Engineers for Tunneling and Geotechnical Engineering Ltd., Aachen/Stuttgart, Germany  
www.wbionline.de

### Abstract

For the large scale projects new high-speed railway line (NBS) Wendingen-Ulm and Stuttgart 21, a total of approx. 100 km long single- and to a small extent also double-track tunnel tubes are foreseen.

In the course of the NBS Wendingen-Ulm, among other structures, the 8.7 km long Boßlertunnel and the 4.7 km long Steinbühlentunnel are planned. The Boßlertunnel is located in Brown Jurassic. Locally, squeezing rock is to be expected. The Steinbühlentunnel is located in White Jurassic, which is locally strongly karstified. For both tunnels, it was investigated whether an advancing test section and through-going exploratory adits respectively would lead to a safer design with regard to construction costs and time.

A total of approx. 52 km single- and double-track tunnel tubes is foreseen for the project Stuttgart 21. The paper exemplarily illustrates the Fildertunnel. With regard to tunneling, the tunnel sections in swelling unleached Gypsum Keuper are of major importance. The principle of resisting support is planned to be carried out.

### 1. Introduction

Approximately 100 km of tunnels are foreseen for the construction of the new high-speed railway lines Wendingen-Ulm and Stuttgart 21. Tunneling in squeezing rock as well as in karstified rock is decisive with regard to construction time and costs of the tunnels for the new high-speed railway line from Wendingen to Ulm (Wittke W. 2004b). The design and construction of tunnels in swelling rock is a major challenge in connection with the project Stuttgart 21.

Figure 1. New high-speed railway line from Wendingen to Ulm.

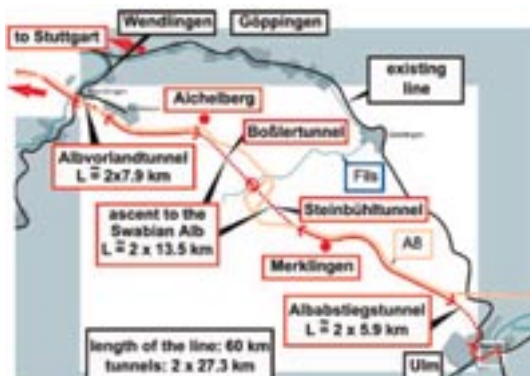

**2. New high-speed railway line wendlingen - Ulm**

**2.1 Tunnels**

The new high-speed railway line Wendlingen - Ulm is planned to go from Wendlingen, passing Aichelberg and Merklingen, to Ulm (Fig. 1). Four comparatively large tunnels are foreseen. The Albvorlandtunnel near Wendlingen is planned with a length of 7.9 km. The ascent to the Swabian Alb from Aichelberg to Merklingen with a length of approx. 13.5 km is also planned to go below ground. In this section, the line is crossing the Filstal. This valley needs to be spanned by a bridge. Therefore two separated tunnels, the Boßlertunnel with a length of 8.7 km and the Steinbühlertunnel with a length of 4.7 km, are required. The fourth tunnel is the 5.9 km long Alabstiegstunnel near the city of Ulm (Fig. 1).

All tunnels are to be constructed as single-track tubes with cross-cuts at distances of  $\leq 1000$  m. The total length of all single-track tunnel tubes results to approx. 55 km.

**2.2 Boßlertunnel - Tunneling in squeezing rock**

For the ascent to the Swabian Alb to the west of the Filstal, the Boßlertunnel is planned with a length of 8.7 km (Fig. 2).

Figure 2. Geological longitudinal section, Boßlertunnel.

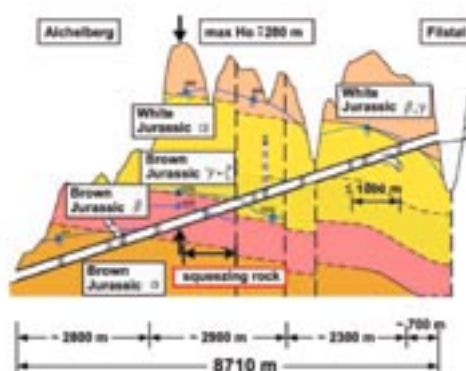

Over a length of approx. 6 km, the tunnel tubes are crossing the layers of the Brown Jurassic (Fig. 2 and 3). The Brown Jurassic  $\alpha$ , which is also known as Opalinuston, consists of a sequence of mudstones and marlstones. The thickness of the Brown Jurassic  $\beta$  amounts to approx. 75 m. In the lower and upper part two sandstone layers, the Lower and Upper “Donzdorfer Sandstone”, are located. The middle part is formed by an alternating sequence of mudstones and sandstones, the so-called “Personatensandsteinzone”.

Above the Brown Jurassic  $\beta$ , mudstones and marlstones, in which layers of limestone are embedded, are located. The permeability of the mudstones and marlstones is very low. The sandstone and the limestone are aquifers.

Figure 3. Layers of the Brown Jurassic.

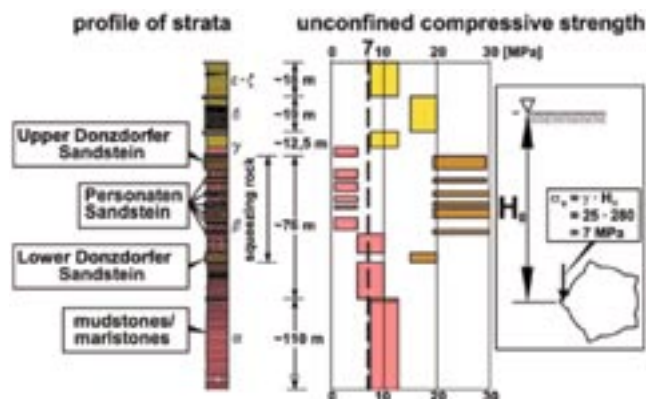

Above the Brown Jurassic the layers of the White Jurassic  $\alpha$  to  $\gamma$  are located (Fig. 2). The White Jurassic  $\alpha$  consists of an approx. 90 m thick sequence of marlstones. In the lower part of it mudstones are embedded and in the upper part limestones. The White Jurassic  $\beta$  and  $\gamma$ , which consists of limestones with deposits of marlstone and are partly karstified, are located above the White Jurassic  $\alpha$ .

According to the results of explorations carried out up to now, several groundwater reservoirs exist in the Brown and White Jurassic, which are separated by mudstone and marlstone deposits with very low permeability. At the moment, the water pressures at the level of the tunnel tubes are estimated to be  $\leq 9$  bar for the White Jurassic.

The unconfined compressive strength of the mudstones of the Brown Jurassic  $\beta$ ,  $\delta$  and  $\epsilon$  to  $\delta$  is comparatively low (Fig. 3). For the Brown Jurassic  $\beta$ , values of 0.5 and 5.0 MPa were evaluated. In the section in which the tunnel is located in the Brown Jurassic, the overburden amounts to 280 m. It cannot be excluded that in these layers the low strength of the mudstones will be exceeded during excavation of the tunnel tubes and squeezing rock conditions occur.

The effect of squeezing rock is illustrated in Figure 4. The Yacambu tunnel in Venezuela could not be completed for a long time, because the shotcrete support could not withstand the high rock pressure.

Figure 4. Tunnel Yacambu (Venezuela), squeezing rock.



Figure 5. Shotcrete method in squeezing rock, deformable lining.



The excavation of the Boßlertunnel in the Brown Jurassic  $\beta$  with an overburden of some 280 m, therefore, is one of the challenges of the new high-speed railway line Wendlingen - Ulm. Using the shotcrete method, a yielding support could be taken into consideration (Rückel & Wittke 1991, Zimmer & Wittke 1996, Fig. 5). With regard to a possible TBM heading, it is presently planned to excavate an advancing test section in the Brown Jurassic  $\beta$  for additional exploration. If this full scale exploration leads to the conclusion that a TBM heading in the layers of the Brown Jurassic  $\beta$ , which are difficult with respect to tunneling, is associated with a too high risk, the tunnel section in the Brown Jurassic  $\beta$  would have to be excavated using the shotcrete method. In the remaining tunnel section of approx. 10 km, however, TBM headings could be carried out.

**2.3 Steinbühl tunnel - Tunneling in karstified rock**

Figure 6 shows a geological longitudinal section of the Steinbühl tunnel, which is located to the south of the Filsbachtal. The length of this tunnel amounts to approx. 4.8 km

Figure 6. Geological longitudinal section, Steinbühl tunnel.

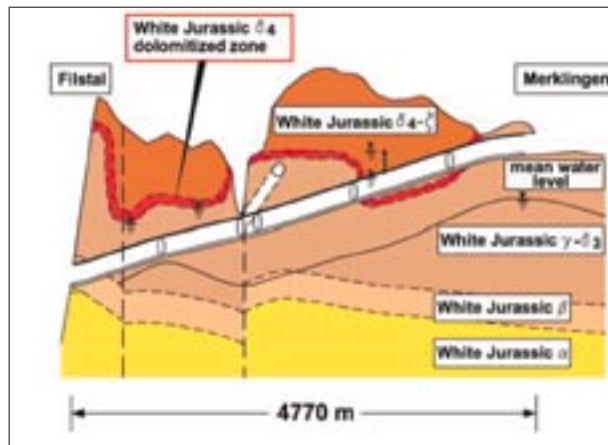

The tunnel tubes are located in the layers of the White Jurassic  $\beta$  to  $\delta_4$  above the average water level. The alignment and the gradient were chosen correspondingly. The water level of the karst aquifer varies. During rainfalls, it is rising by several 10 m. Thus, also for this tunnel the water pressure is expected to be within 3 to 5 bars and the tunnel tubes need to be sealed along the whole circumference by a watertight lining which is dimensioned against water pressure.

The layers of the White Jurassic are karstified. In the Swabian Alb, many karst phenomena and cavities are known. Examples are the “Mordloch” (Fig. 7) and the “Falkensteiner Höhle”, a 5 km long cave in the White Jurassic  $\delta$ . Furthermore, karstified master joints occur in the layers of the White Jurassic  $\beta$  to  $\delta$  (Fig. 8).

Figure 7. Mordloch, karst channel in the White Jurassic  $\beta$  (Binder 1989).



8. Karstified master joints in the White Jurassic  $\gamma$ .



## 7. mednarodno posvetovanje o gradnji predorov in podzemnih prostorov

### TEMA 2 | NAČRTOVANJE KONSTRUKCIJ IN VZDRŽEVANJE PODZEMNIH PROSTOROV

Figure 9. Main types of karstification in the White Jurassic.

Figure 10. Possible cavities in the cross-section of the tunnel.

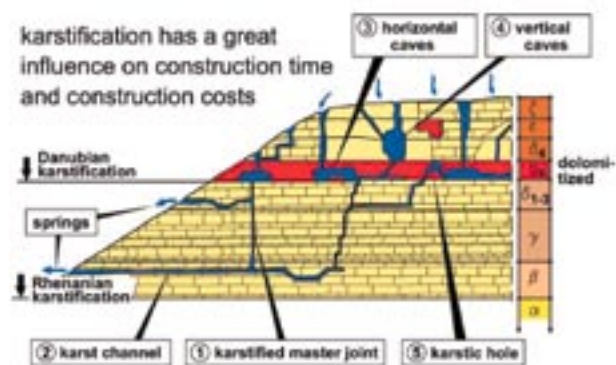

In Figure 9, the main types of karstification in the layers of the White Jurassic are illustrated. Figure 10 shows a vertical section through the cave “Laichinger Tiefenhöhle”, in which the contour of one tunnel tube of the new high-speed railway line is plotted.

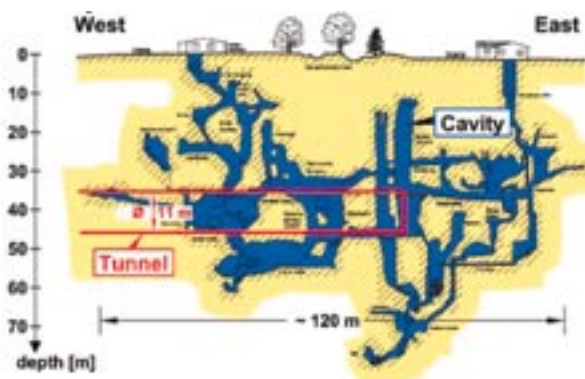

Since it cannot be excluded that karst phenomena of importance for tunneling are encountered during the excavation of the Steinbühl tunnel, corresponding support measures are foreseen in the tunnel design. Figure 11 exemplarily shows the support of a tunnel tube in case of a karst cavity located above the tunnel’s roof. For stability reasons a concrete body is to be constructed between the tunnel and the karst cavity. Thus, the karst cavity as the main flow path will be maintained so that groundwater conditions remain unchanged during tunneling. Figure 12 exemplarily shows the support in case of a karst cavity located underneath the invert of the tunnel.

Figure 11. Support of tunnel in karstified White Jurassic, karst cavity above the roof.

Figure 12. Support of tunnel in karstified White Jurassic, karst cavity underneath the invert.

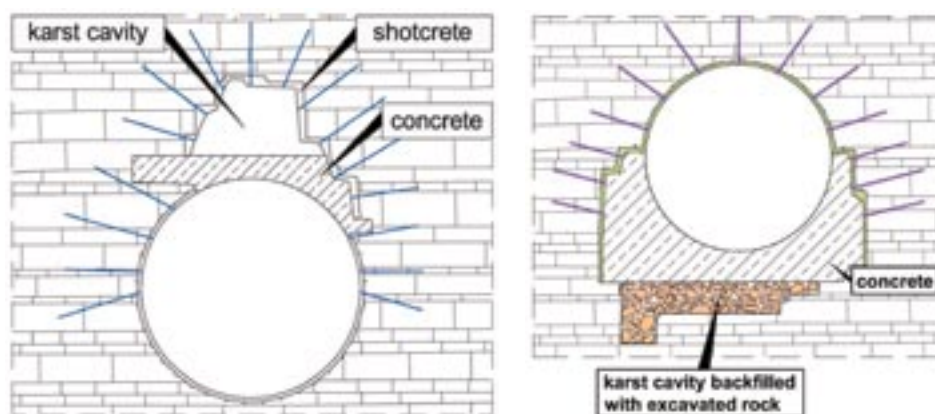

Also for the Steinbühl tunnel it was investigated whether the excavation of advancing exploratory adits in karstified rock is of use. This investigation led to the recommendation to drive two advancing exploratory adits located within the cross-sections of the tunnel tubes over the full length of the Steinbühl tunnel (Fig. 13). From these adits, karst cavities adjacent to both tunnel tubes can be explored by seismic methods and supplementary drillings and also stabilized if required. If these measures are carried out prior to the excavation of the tunnel tubes, the risk for TBM-tunneling is considerably reduced.



Figure 13. Exploratory adit in karstified rock, Steinbühl tunnel.

Figure 14. Stuttgart 21, overview

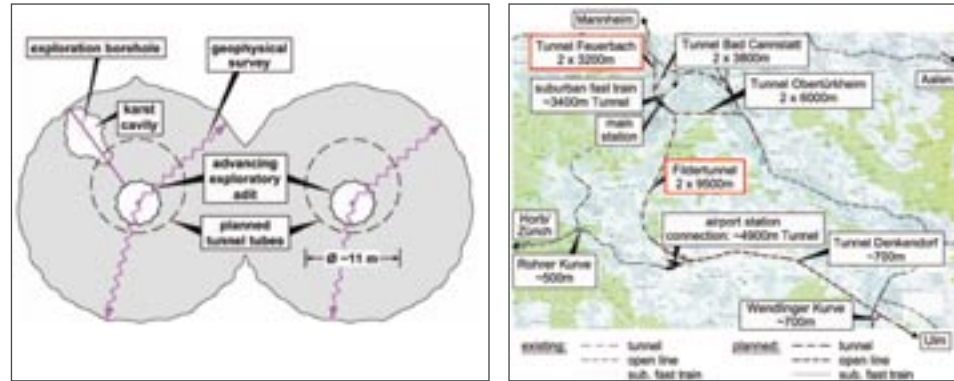

### 3. Stuttgart 21

#### 3.1 Tunnels

In the city of Stuttgart, five tunnels are planned (Fig. 14). The tunnel Feuerbach with a length of approx. 3.2 km is connecting the high-speed railway line Mannheim-Stuttgart with the new main station. The Fildertunnel with a length of approx. 9.5 km shall provide the main connection from the new main station to the Stuttgart airport and further to the new high-speed railway line Wendlingen-Ulm. As further essential tunnel structures, the tunnel Bad Cannstatt with a length of approx. 3.8 km and the tunnels to Ober- and Untertürkheim are to be constructed. The tunnel Obertürkheim undercrosses the Neckar river in a comparatively low depth. The total length of this tunnel is approx. 6 km.

To remove traffic from the ground surface and to improve the suburban fast train connections, additional tunnels with a length of approx. 3.4 km are planned. For the connection to the airport, further tunnels with a length of approx. 4.9 km are foreseen. In addition several comparatively short tunnels like the Rohrer Kurve, the Wendlinger Kurve and the tunnel Denkendorf are planned.

The total length of all single-track and double-track tunnel tubes for the project Stuttgart 21 is approx. 52 km. In the following, the Fildertunnel with its special features with respect to tunneling will exemplarily be presented.

#### 3.2 Fildertunnel - Tunneling in swelling rock

The Fildertunnel, which leads from the new Stuttgart main station to the Filder Plain, has a length of approx. 9.5 km (Fig. 15).

The tunnel crosses all layers forming the valley of Stuttgart, which are located above the "Lettenkeuper". At the beginning of the tunnel, the cross section is located in the leached Gypsum Keuper over a length of 200 to 300 m. In the following, it passes sulfate rock containing gypsum and anhydrite over a length of approx. 4.3 km. Here, the leaching front is located 30 to 45 m above the roof of the tunnel. Underneath the anhydrite level, which is located 20 to 30 m above the tunnel's roof, the sulfate rock consists mainly of anhydrite. The tunnel is located in the "Schilfsandstein", the "Kieselsandstein" as well as the "Unteren Bunten Mergel" and "Oberen Bunten Mergel" over a length of approx. 750 m. The sandstones and siltstones of the "Stubensandstein" are crossed by the tunnel over a length of some 2.5 km. The re-

## 7. mednarodno posvetovanje o gradnji predorov in podzemnih prostorov

### TEMA 2 | NAČRTOVANJE KONSTRUKCIJ IN VZDRŽEVANJE PODZEMNIH PROSTOROV

maining tunnel sections are located in the “Knollenmergel” and the silty mudstones and sandy limestones of the Black Jurassic (Lias  $\alpha$ ).

Figure 15. Geological longitudinal section, Fildertunnel

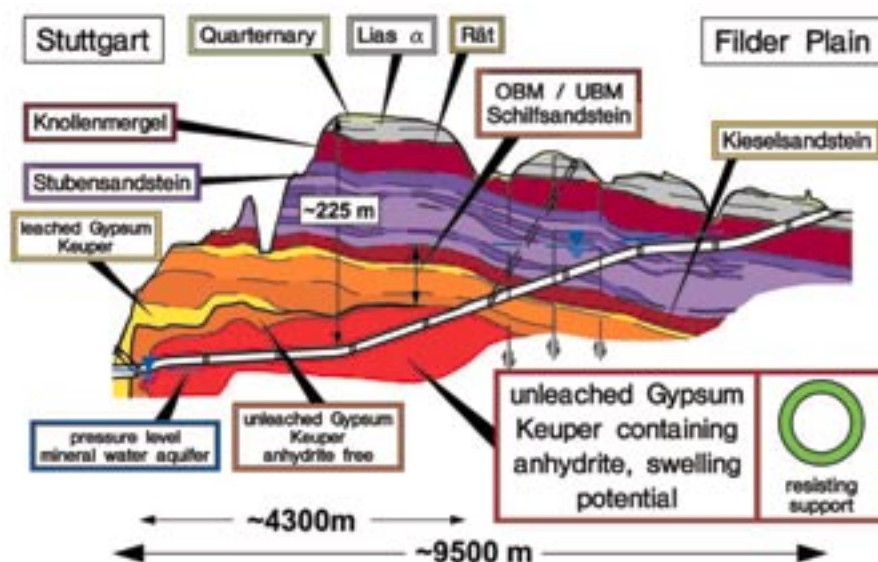

The unleached Gypsum Keuper is a major challenge for design and construction of the Fildertunnel. It consists of a horizontal alternating sequence of sulfate-containing clay- and siltstones and pure sulfate rock. The sulfate is found in two different modifications, as gypsum and as anhydrite. Both modifications can be found at the same time, if the rock is dry. If water gains access to the rock, however, anhydrite transforms into gypsum. This chemical process results in an increase of the solid volume by approx. 60 %. This volume increase is denoted as swelling.

The swelling behavior of the unleached Gypsum Keuper is also influenced by the water uptake of clay minerals.

The volume increase due to swelling causes major swelling deformations. If these are confined, great swelling pressures occur, which have led to severe damages of tunnel linings in many cases in the past.

The maximum overburden of the Fildertunnel amounts to 225 m. The design concept for the Fildertunnel is based on the principle of resisting support (Fig. 16). Thus, the lining is designed to resist the developing swelling pressure.

In a greater distance to the leaching front the unleached Gypsum Keuper has a very low permeability according to experience. Because of the comparatively great distance of the tunnel gradient to the leaching front, it is to be expected that the rock mass remains dry and thus no swelling occurs, if no water gains access to the rock during the stages of construction. This was an important criterion for determination of the gradient. Another criterion was to have the tunnel passing the leaching front in an area in which the overlaying rocks are almost dry. Furthermore, due to the chosen deep location of the gradient, a tunnel lining sub-

Figure 16. Design principles for tunnels in swelling rock

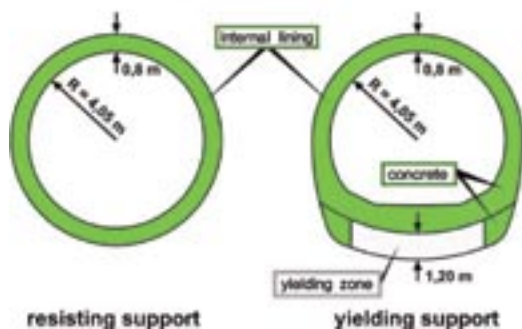

jected to swelling pressure underneath the invert can be supported by a sufficiently thick rock layer consisting of hard rock. Thus, significant heavings of the tunnel tubes due to swelling are not to be expected.

The principles of resisting support and yielding support respectively are presently used for the design of tunnels in anhydritic, swelling rock (Fig. 16). In both cases, it is assumed that water to initiate the maximum swelling load and full swelling respectively is available in sufficient quantities. Consequently, the designed measures have to be carried out over the full length of the tunnel in swelling rock.

Based on observations, the hypothesis was made that, in the area of the transition from water bearing to anhydritic rock, self-sealing due to swelling occurs around the tunnel, if the resisting principle is applied. As a consequence of this self-sealing effect, seepage through the rock along the tunnel, and thus also swelling, is interrupted at a certain distance from the water bearing formation (Wittke M. 2003, 2004).

In a research project carried out by WBI, a rock mechanical and hydraulic model and a corresponding 3D-FEM-code have been developed, which describe the corresponding phenomena. It is expected that the results of this work will lead to remarkable cost savings along with the design of tunnels in swelling rock.

### References

- Baur, R. 2002. Tunnelbau im Projekt Stuttgart 21. *Geotechnik* 25 (3): 153 - 156.
- Baur, R. & Erichsen, C. 2000. Challenges in tunneling according to 40 km tunnels for the DB Projekt Stuttgart 21. *Proc. of the EUROCK 2000 symp., Aachen 2000*. Essen: Verlag Glückauf.
- Beiche, H. 1991. Bemessung und Bau eines Tunnels in anhydrit-haltigem Gebirge. *Proc. 9. Nat. Felsmechanik Symposium, Aachen 1990*. Essen: Verlag Glückauf.
- Bernhardt, K. & Rock, D. 1995. Der Engelbergbasistunnel: Bau und Finanzierungskonzept eines Autobahntunnels mit außergewöhnlichen Querschnittsabmessungen in schwierigen Gebirgsverhältnissen. *Forschung + Praxis* 36, *Proc. World Tunnel Congress, Köln 1995*.
- Binder, H. 1989. Höhlenführer Schwäbische Alb. Konrad Theis Verlag.
- Grob, H. 1972. Schwelldruck am Beispiel des Belchentunnels. *Proc. Int. Symposium für Untertagbau, Luzern*: 99 - 119.
- Grüter, R. & Liening, B. 1976. S-Bahn Stuttgart, Planung und Bau der Haltestelle Schwabstraße (Baulos 11) und der unterirdischen Wendeanlage (Baulos 12), Teil I. *Proc. Baugrundtagung, Nürnberg 1976*.
- Jäckle, P. 2002. Die Tunnel der Neubaustrecke Wendlingen - Ulm. *Geotechnik* 25 (3): 157 - 161.
- Kiehl, J. R. 1990. Ein dreidimensionales Quellgesetz und seine Anwendung auf den Felshohlraumbau. *Proc. 9. Nat. Felsmechanik Symposium, Aachen 1990*. Essen: Verlag Glückauf.
- Kirschke, D., Kuhnhenh, K. & Prommersberger, G. 1991. Der Freudensteintunnel: Eine Herausforderung für den planenden Ingenieur. *Ibw* 7: 5 - 39.
- Klonsdorf, G. & Schaser, F. 1991. Baudurchführung des Freudensteintunnels, Bergmännische und offene Bauweise. *Ibw* 7: 118 -172.
- Marquart, P. 2004. Die Geologie weist ihren Weg - Tunnelbau in den Gebirgsformationen rund um Stuttgart und auf der Schwäbischen Alb. *Geotechnik* 27 (2): 99 - 103.
- Paul, A. & Wichter, L. 1992. Das Langzeitverhalten von Tunnelbauwerken im quellenden Gebirge - Neuere Meßergebnisse vom Stuttgarter Wagenburgtunnel. *Proc. 10. Nat. Felsmechanik Symposium, Aachen 1992*. Essen: Verlag Glückauf.
- Rückel, M. & Wittke, W. 1991. Abschluß von Einlagerungskammern in druckhaftem Gebirge, Konzept und in situ Nachweis. *Proc. 9. Nat. Felsmechanik Symposium, Aachen 1990*. Essen: Verlag Glückauf.
- Wittke, M. 2003. Begrenzung der Quelldrücke durch Selbstabdichtung beim Tunnelbau im anhydritführenden Gebirge. *Geotechnik in Forschung und Praxis, WBI-PRINT 13*. Essen: Verlag Glückauf.
- Wittke, M. 2004. Bemessung von Tunnels im quellfähigen Gebirge unter Berücksichtigung der Selbstabdichtung. *Geotechnik* 27 (2): 136 - 141.
- Wittke, W. 2004a. Planung, Bau und Überwachung von Tunnels in quellfähigem Gipskeuper. *Geotechnik* 27 (2): 104 - 111.
- Wittke, W. 2004b. Ursachen und Vermeidung von Termin- und Kostenüberschreitungen bei Tunnelbauten der Infrastruktur, unpubl.
- Wittke, W. & Reißler, P. 1976. S-Bahn Stuttgart, Planung und Bau der Haltestelle Schwabstraße (Baulos 11) und der unterirdischen Wendeanlage (Baulos 12), Teil II. *Proc. Baugrundtagung, Nürnberg 1976*.
- Wittke, W., Wittke, M. & Wahlen, R. 2004. Zum Quellgesetz für anhydritführenden, unausgelaugten Gipskeuper. *Geotechnik* 27 (2): 136 - 141
- Wittke-Gattermann, P. 1998. Verfahren zur Berechnung von Tunnels in quellfähigem Gebirge und Kalibrierung an einem Versuchsbauwerk. *Geotechnik in Forschung und Praxis, WBI-PRINT 1*. Essen: Verlag Glückauf.
- Zimmer, M. & Wittke, W. 1996. Entwurf und Ausführung eines verformbaren Ausbaus in stark durchhaftem Gebirge. *Proc. 11. Nat. Felsmechanik Symposium, Aachen 1994*. Essen: Verlag Glückauf.

## Gradnja predora Podmilj

Šiljić Enver, univ.dipl.inž.rud.  
mag. Frantar Matjaž, univ.dipl.inž.rud.

### 1. Uvod

Predor Podmilj je del bodoče avtoceste med Ljubljano in Celjem. Nahaja se na odseku Blagovica-Vransko, pododsek Blagovica-Trojane in je prvi od štirih predorov iz ljubljanske smeri proti Celju.

Predor Podmilj je projektiran kot dvocevni predor z dvema voznima pasovima. Predorski cevi sta na medsebojni razdalji med 27 in 48m. Višina nadkritja se spreminja in je na vzhodnem portalu cca. 35m in na zahodnem portalu 38m.

### 2. Splošni podatki

#### 2.1. Geološki pogoji

Z litološkega kot tudi geotehničnega vidika je trasa predora razdeljena na dva odseka.

Od vzhodnega portala do stacionaže km 83+415 trasa predora potekala po masivnem svetlo sivem dolomitu. Kamnina je predvsem ob razpokah in manjših prelomih ploskvah vsebovala povečan delež rumeno sive meljaste komponente. Kontakt masivnega dolomita z nižje ležečimi plastmi skitske serije, kjer je prevladoval rumeno siv dolomit s prehodi v rumeno rjav lapornati dolomit. V njem so nastopale tudi nepravilne leče in vložki rdečkastega peščenjaka, sivega laporja in črnega brečastega dolomita. Izkop v takšnih plasteh je potekal do stac. km 83+415, kjer se je pojavil stik z nižje ležečimi grōdenskimi plastmi.

Od stac. 83+415 do zahodnega portala je prevladoval rožnat peščenjak z lečami vijoličastega muljevca ter sivi glinasti skrilavec in meljevec. Grōdenska serija klastičnih kamnin se je nadaljevala vse do stac. km 83+552, kjer se je zopet pojavil narivni kontakt z zgoraj ležečimi skitskimi plastmi. Tako je izkop predora med stac. km 83+552 in 83+615 zopet potekal v skitskih plasteh sivega lapornatega dolomita.

#### 2.2. Klasifikacija hribine

Celotna trasa predora Podmilj je bila razvrščena po avstrijski klasifikaciji kakovostnih razredov hribin v razrede B2, C2, C3 in PC. Omenjena avstrijska klasifikacija ustreza načelom NATM.

	HK	Leva cev		Desna cev	
		stacionaža	dolžina	stacionaža.	dolžina
		od - do	[m]	od - do	[m]
vzhod	PC	83+168 83+178	10	83+080 83+090	10
	B2	83+178 83+272	94	83+090 83+348	258
	C2	83+272 83+637	365	83+348 83+371	23
	C3	-	-	83+371 83+452	81
	C2	-	-	83+452 83+617	165
zahod	PC	83+637 83+668	31	83+617 83+632	15

V tabeli so prikazane posamezne dolžine odsekov po kakovostnih razredih (tipih) hribin, ki v skupni dolžini dosežejo dolžino 1052 m, kar je enako dolžini rudarskega izkopa obeh predorskih cevi brez širokega izkopa na portalih.

### 3. Konstrukcije objekta tehnologija gradnje

#### 3.1. Tehnični elementi predora

##### Tehnični elementi:

- Leva cev (smer Ljubljana - Celje)
  - dolžina leve cevi: 613 m (od km 83.0+85.00 do km83.6+98.00)
  - dolžina rudarskega izkopa: 500m (od km 83.1+68.00 do km83.6+68.00)
  - dolžina pokritega vkopa: vzhod 83m, zahod 30m
  - maksimalna nadmorska višina: okoli 523m na vzhodnem portalu predora,
  - vzdolžni sklon: 0,5-1,6 %
  - prečni sklon vozišča: 2,5 – 3,3 %
  - minimalni horizontalni radij v predoru 1000m
- Desna cev (smer Celje - Ljubljana)
  - dolžina desne cevi: 622 m (od km 83.0+40.00 do km83.6+62.00)
  - dolžina rudarskega izkopa: 552m (od km 83.0+80.00 do km83.6+32.00)
  - dolžina pokritega vkopa: vzhod 40m, zahod 30m
  - maksimalna nadmorska višina: okoli 523m na vzhodnem portalu predora,
  - vzdolžni sklon: 0,5-1,6 %
  - prečni sklon vozišča: 2,7 – 3,1 %
  - minimalni horizontalni radij v predoru 1000m

#### 3.2. Prečni prerez predora

Velikost prečnega prereza predora je določena s svetlim profilom predora. Širina vozišča znaša v predoru 7,70m, z dvema voznima pasovoma širine 3,50m in obojestranskima robnima trakovoma širine 0,35m. Višina prevoznega profila je 4,70m. Površina svetlega profila predora znaša 65,0m<sup>2</sup>.

Zaradi vzdrževanja in tudi zaradi nujnih primerov, sta na vsaki strani vozišča predvidena pločnika, ki sta 0,15m dvignjena nad površino ceste, z nagibom 2 % proti vozišču. Najmanjša širina pločnikov je 0,85m, vertikalna razdalja pa 2,0m. Dejanska širina pločnikov je 0,92m. Ta je pogojena s prostorskimi zahtevami za namestitev cevi za kable pod njimi in z zahtevami, ki so rezultat zadostne oddaljenosti od sten predora.

Z upoštevanjem horizontalnega radia trase je določen najmanjši prečni sklon vozišča, ki znaša 2,5 %, največji prečni sklon vozišča v predoru Podmilj pa znaša 3,3 %. Zgornji ustroj vozišča je sestavljen iz treh slojev: sloj betona debeline 24cm, sloj bitudrobirja debeline 5cm in betonska stabilizacija debeline 20cm.

Za obe predorske cevi je bila uporabljena enaka geometrija notranje betonske obloge. Debelina notranje betonske obloge v predoru znaša 30cm medtem, ko znaša debelina obloge v pokritem vkopu 70cm.

V predoru Podmilj so za izvedbo napeljav, čiščenja in za ostale namene izvedeni različni tipi niš. Niše se izdelajo v času izkopa predora in so glede na zahteve podprte z armaturno mrežo, sidri in brizganim betonom. V predoru so izdelani naslednji tipi niš: niša za »klic v sili, protipožarna niša, elektro niša in čistilna niša.

V času same izgradnje se je na osnovi novih zahtev po varnosti v cestnem prometu skozi predore glede na celotno dolžino predorske cevi izvedel povozni prečnik. Prečnik je lociran v levi predorski cevi na stac. km 83+352 in v desni cevi na stac. km 83+322 v dolžini 35m.

Hribinske vode, se kontrolirano zbirajo in odvajajo s pomočjo drenažnih cevi  $\Phi 200$  ter ločeno odteka od cestne vode, ki bo speljana v zaprti zbiralnik odpadne vode pred predorom. Odvodnjavanje cestišča je izvedeno z votlimi montažnimi betonskimi robniki, ki so položeni na nižjem robu cestišča. Odvodnjavanje cestišča poteka po celotni dolžini predora do jaška pred zahodnim portalom, ki je povezan z zaprtim zbiralnikom odpadnih vod. Hribinska voda iz bočnega drenažnega sistema bo speljana v črpalnico, iz katere se bo preko vodovodnega sistema oskrbovalo vodohran Podmilj za potrebe protipožarne vode v predoru.

Čistilni in protipožarni jaški so nameščeni na vsakih 100m z namenom preprečevanja morebitnega širjenja požara v primeru nesreče ali zaradi vžiga ob morebitnem razlitju vnetljive tekočine na cestišču.

V predoru Podmilj so predvidene električne instalacije za razsvetljavo predorskih cevi, električne instalacije v elektro nišah ter električne instalacije za varnostne in signalne naprave (nadzorni sistem, prometno signalizacijo, požarno javljanje in niše za »klic v sili«). Od komunalnih energetskih vodov so predvideni 20kV energetski kabli za napajanje elektro niš ter optični kabli.

Prosta višina nad svetlim profilom predora v temenu zagotavlja dovolj prostora za vgradnjo razsvetljave. Glede na dolžino predorskih cevi v predoru Podmilj ni predvideno prisilno prezračevanje s pomočjo ventilatorjev.

Pred vhodom v levo predorsko cev na zahodu je locirana pogonska centrala, ki je transformatorska postaja s komandnim prostorom za napajanje predora z električno energijo.

### 3.3. Izkop predora

Gradnja predora Podmilj se je izvajala po načelih »nove avstrijske metode gradnje predorov« - NATM (New Austrian Tunnel Method), ki je zasnovana tako, da hribino okrog območja izkopa obravnava kot breme ter tudi kot obroč, ki breme prevzema. Zaradi zmanjšanja deformacij hribine v okolici predorske cevi je bil izveden izkop predora po fazah: kalota, stopnica in talni obok (temelj). Vsaki fazi izkopa je sledila takojšnja vgradnja primarne podgradnje, pri čemer so osnovne podporne elemente predstavljali brizgani beton, armaturne mreže, jekleni TH loki in sidra.

Z vzhodne strani se je izkop in podgrajevanje po začetni PC kategoriji izvajal v hribinski kategoriji B2. Izkop v masivnem dolomitu se je izvajal z tehnologijo vrtnanja in miniranja, kjer je bil korak napredovanja 1,5m. V osrednjem delu predora na kontaktu med triasnimi karbonatnimi in grödenskimi klastičnimi kamninami se je izvajal izkop

v hribinski kategoriji C2 v desni cevi tudi v C3 kategoriji. V tem območju se je izkop hribine izvajal z predorskim bagrom. Izkop kalote v C2 kategoriji se je izvajal v korakih dolžine od 1,2 do 1,3 m, v hribinski kategoriji C3 pa korak ni presegal 1,0m. Izkop kalote v C3 kategoriji se je izvajal z puščanjem varovalnega jedra. Pred pričetkom izkopa na kaloti so se na čelu po obodu vgrajevale varovalne sulice dolžine 3-4m. Odpiral se je obod ob varovalnem jedru, kateremu je sledil takojšen nanos varovalnega brizganega betona na izkopane boke, strop in čelo kalote. Kot dodatni podporni ukrep se je uporabljal tudi začasni talni obok v kaloti iz brizganega betona ter razširjena peta kalote, s katerimi smo preprečili velike vertikalne pomike izkopanega profila. Izkop stopnice je kontinuirano sledil izkopu kalote na minimalni razdalji, ki še omogoča nemoteno delo na kaloti. Obseg podpornih elementov v stopnici je bil glede na kaloto enak, izkopni korak pa je bil enak dvojnemu koraku v kaloti.

Na zahodni strani predora v območju portalov v hribinski kategoriji PC, kjer je bila hribina preperela in močno poškodovana so se zaradi majhnega nadkritja pojavljale deformacije. Takojšnja vgradnja dodatnih podpornih elementov je zagotavlja hitro ustavitve širjenja deformacij. Zakasnela vgradnja podpornih elementov, ali premajhna količina le teh, bi lahko povzročila deformacije, ki bi sprožile pomike in nestabilnost brežin na portalih. Izkopni profil je bil razdeljen na kaloto, začasni talni obok, stopnico in talni obok. Glede na razmere je bilo izvedeno tudi podpiranje čela kalote s pomočjo cevnega ščita (»pipe roof«) katerega je sestavljalo 21 zainjektiranih jeklenih cevi  $\Phi$  114 mm (4 inch), dolžine 15 m, ki so razporejene po obodu kalote na 60 cm. Cevi smo zavrtali pod naklonom  $5^\circ$  od točke O, ki leži v zgornjem delu kalote. Izkopu kalote je sledil izkop stopnice na minimalni razdalji, ki omogoča delo na kaloti.

V skladu s principom NATM je stabilnost izkopnega profila predora dosežena z vgradnjo primarne podgradnje vključno s temelji in talnim obokom, ki so sestavni del primarnega podporja. Za predor Podmilj je bila načrtovana 30cm debela notranja sekundarna obloga iz cementnega betona MB 30, ki se je vgradil po dokončanju vseh izkopov in umiritvi konvergenca.

Pri izkopu predorskih cevi je bilo izkopano skupaj  $98.614\text{m}^3$  materiala in na predvzletih  $70.385\text{m}^3$  od katerega je bilo cca.  $88.000\text{m}^3$  nevgradljivega materiala, kar pomeni, da ga je bilo potrebno trajno deponirati. V ta namen je bila namenjena trajna deponija Briše v bližini Izlak, v kateri se je tudi deponiral nevgradljivi izkopani material iz predora Trojane in celotnega AC odseka Trojane – Blagovica.

V sklopu gradnje predora Podmilj je bila izvedena tudi sanacija opuščene kamnoloma, ki se je nahajal v neposredni bližini bodoče AC in predora Podmilj ob magistralni cesti M10 Ljubljana – Celje, ki je predstavljal zelo grob poseg v okolico.

Samo izkoriščanje kamnoloma v preteklosti je bilo tehnično nestrokovno in nepravilno, ker je povzročilo visoke brežine strmega naklona brez etažnih ravnin – berm. Prosto stekajoče vode so pospeševale erozijo in onemogočale naravno zaraščanje opuščene območja kamnoloma. Na vrhnjem delu in pod previsnimi stenami so ostale nevarne samice, ki bi se v nadaljevanju erozije lahko porušile v dolino. Podatka kdaj se je izkoriščanje kamnoloma opustilo ni, vendar je kamnolom miroval vsaj desetletje. V ta kamnolom se je v začetku, zaradi neposredne bližine delovišča predora

## 7. mednarodno posvetovanje o gradnji predorov in podzemnih prostorov

### TEMA 2 | NAČRTOVANJE KONSTRUKCIJ IN VZDRŽEVANJE PODZEMNIH PROSTOROV

začasno odlagal nevedgradljivi izkopani material, ki je sčasoma zapolnil kamnolom do vrha. Prvotno je bil kamnolom predviden le kot začasno odlagališče, od koder bi se del odložene hribine porabil za zasutje pokritih ukopov, preostali del pa bi se odpeljal v deponijo Briše.

Na predlog podjetja NGR, d.d. v soglasju z Naročnikom in v dogovoru z lastnikom zemljišča, ter priporočilu rudarskega inšpektorja se je pristopilo k sanaciji kamnoloma in končni ureditvi brežin odloženega materiala po rudarskem projektu sanacije kamnoloma. Sanacija in končna ureditev opuščene kamnoloma bosta bistveno vplivala na boljši izgled okolice in zagotovila okoljevarstvene zahteve. To je tudi dodatni prispevek k urejanju našega skupnega prostora, ki se nahaja v bližini gradbišč AC križa.

Naročnik: DARS d.d. Družba za avtoceste v RS, Celje

Projektant: IRGO Consulting d.o.o. Ljubljana

Izvajalec del: NGR d.d. Maribor

Nadzor: DDC d.o.o. Ljubljana

Čas gradnje: 2002-2004

Dolžina objekta: Leva cev: 613m, Desna cev: 622m

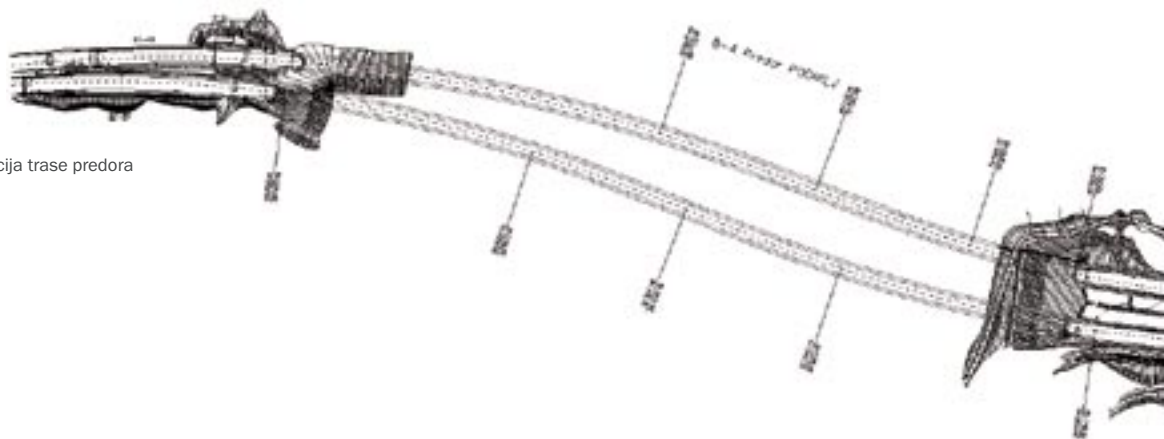

Slika 1: Situacija trase predora

Slika 2: Vzhodni predkop - začasni portal



Slika 3 : Vzhodni predkop - končni portal





## The Lainzer Tunnel Project

---

Oliver K. Wagner, Dipl.-Ing. / Josef Koinig, Dipl.-Ing.  
Eisenbahn-Hochleistungsstrecken AG (HL-AG)  
Geotechnics and tunnelling division  
A-1150 Vienna, Sparkassaplatz 6  
Tel.: +43 1 8957769 1569  
Fax: +43 1 8957769 477  
E-mail: oliver.wagner@hl-ag.com

### Abstract

The paper deals with the main aspects for the design of the new strategic railway link between the Western railway network and the Southern network in Austria, the Lainzer Tunnel project in Vienna.

A general survey of the project and its time schedule is given. Key issues are the conventional tunnelling, principally used tunnel profiles, track work systems and safety and emergency facilities as well as the increased fire-resistance of the inner linings.

Keywords: Railway tunnel, soft ground conditions, side gallery, conventional tunneling, water-impermeable inner lining, vibration control, increased fire-resistance for inner linings, safety and emergency facilities

### 1. Introduction

Like whole Europe, Austria is also confronted with the task to control the considerable increase of passenger and freight transportation in an economic and ecologically compatible way.

Therefore, 15 years ago, a big modernisation program for railway infrastructure in Austria was started. The key issue of this program is the so called Danube corridor. The capacity of this passage should be advanced up to four tracks between Linz and Vienna. The Lainzer Tunnel project, the new strategic link between the western and southern railway network, is the most eastern part of this corridor.

The client for this project is the Eisenbahn-Hochleistungsstrecken AG (HL-AG).

In March 1989 the Austrian Parliament passed the high-capacity railway lines act, providing for the creation of a high-capacity rail network and the establishment of an engineering and construction company to plan and build these lines. The act supplied the legal framework for the foundation of HL-AG in April of that year.

Since that time, the HL-AG was creating an efficient rail network that will enable present and future railway operators to match growing demand with optimum services, always considering the topics land use and environment in addition to the main focus transit and technology.

### 2. Project development

#### 2.1 History

The first planning concepts for the construction of an efficient rail connection linking the Western, Southern and Donaulände Railways in Vienna date back to 1974. In the late 1980's, when Austria's entry into the European Union was foreseeable in the short term, the project took on a new economic, environmental and traffic-related significance. In particular, the fact that the Lainzer Tunnel must, as part of the east-

west axis, meet the special demands of an urban environment, has resulted in the adoption of the following objectives and practical aims:

- The efficient connection of the likewise newly constructed high capacity line to St. Pölten und Linz,
- an efficient connection to the Southern and Donaulände railways, i.e. to the future Vienna Main Station and the planned cargo terminals in the south of Vienna, as well as
- the optimization of the Local Commuter Train Service through the construction of new urban railway lines in the city area and the disentanglement of local and intercity traffic on the existing lines

Another objective, which is particularly important with regard to the protection of people living near railways, is the minimization of noise pollution, since railway traffic on the existing connecting line - which does, after all, date from the 2<sup>nd</sup> half of the 19<sup>th</sup> century - is today responsible for  $L_{Aeq}$  values of 70 dB in residential areas [1].

Fig. 1 View of the Lainzer Tunnel

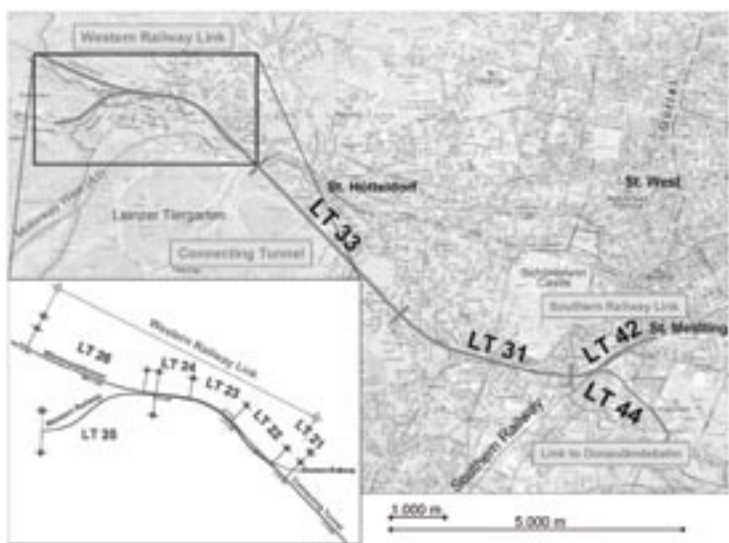

#### 2.2 Time schedule

The most important milestones in the course of the development of the project are:

- 1990: HLAG is commissioned with the task of planning the project
- 1991/92: The route of the line is decided upon, with large-scale public involvement (evaluation questionnaire sent to every household), and many different civic action groups from the three Vienna districts concerned
- 1993: The hearing (i.e. Para. 4 proceedings), takes place in conformity with the High-Speed Railway Line Act, accompanied by extensive public information campaigns (e.g. exhibitions and public discussions); Enact-

ment of the Lainzer Tunnel route

- 1996: Submission of the entire project, divided into four sections, in order to obtain building permit, in accordance with railway construction regulations
- 1997 to 1998: Four building negotiation sessions are held with the railway construction regulation authorities, dealing with the four project sections, including a total of 3851 parties present at the sessions. In the course of the negotiations, 721 parties (18.7 %) voiced their opinions on the project
- 1997 bis 2000: Public information of the legally-valid building permits
- 1999: Start of construction at contract section LT21 in the west – a river crossing
- 2000: Construction begins at the rest of the contract sections in the Western Railway Link (LT 22 - LT 25)
- Beginning of 2001: Start of construction at the first contract section in the south-

ern railway link (LT 42)

- Middle of 2001: Suspension of the building permits by the supreme court of justice - interruption of construction works, merely tunnelling works are allowed to complete
- 2001 to 2003: Continuation of submission to obtain building permits again - update of the safety concepts
- Beginning of 2002: Public information of the second building permits for the Western and Southern Railway Link
- September 2004: Public information of the second building permit for the Connecting Tunnel

The design of the tunnel profile and the longitudinal section is generally based on the national standard for the design of high capacity railway tunnels in Austria [2]. In consideration of much enforcement in the urban area, the layout of the line was determined with a maximum allowed speed of 160 km/h.

With this compromise it was possible to find a route which is running under build-up areas just for ten percent.

### 3. General overview form west to south

#### 3.1 Western railway link

This section in the western area of Vienna connects the two existing tracks of Western Railway and two actually new built tracks from St. Pölten to Vienna with two tracks of the Lainzer Tunnel.

Beginning in the west the Western Railway tracks lead under the existing Western Railway Line by 3 km of ramps, where they are connected to the tracks from the Wienerwaldtunnel in a approximately 500 m long four-tracked hall (LT24), which is parted in sections. In an eastward direction this hall branches out to two single tracked tunnel tubes which underpass the existing western railway line (LT22, fig. 2) and discharge in the already existing river crossing (LT21, cut and cover) where the single track tubes are brought together. The eastern end of this site also represents the transition section leading to the main part of the project – the so called Connecting Tunnel.

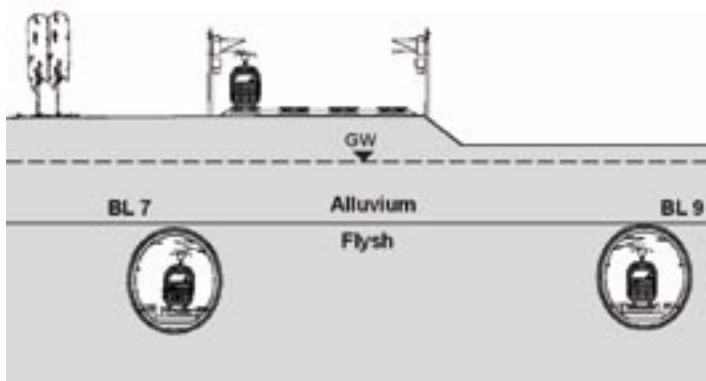

Fig. 2: Cross section in lot LT22

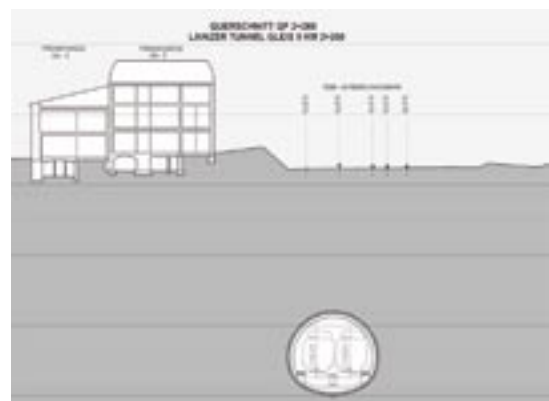

Fig. 3: Cross section in lot LT31

### 3.2 Connecting Tunnel

This ca. 6.6 km long section is in fact the link of Western and Southern Railways. The whole section consists of a two track tunnel tube with an excavation cross-section of ca. 130 m<sup>2</sup>. The longitudinal lining is a trough profile.

The tunnel underpasses the main connection road (B1) to the western motorway in the beginning and declines with 4.5 ‰ under the Lainzer Tiergarten, a nature protected wood. In succession the tunnel crosses two densely populated districts. Here the lowest part of the lining is located. Going on the route follows the already existing connecting line and respectively the ancient range of it, which fulfils the connection function at the surface at the moment. The section ends some meters in front of another crossing of a main road – the connection to the southern areas of Vienna.

The connecting tunnel consists of two contract sections – lot LT31 and LT33.

LT33 is to be built in hard rock, which is made up of flysch, marl, clay stone and calcareous cliffs. The overburden varies from 10 m under the B1 up to 120 m under the Lainzer Tiergarten.

Because of little mountain water and a comparative high pressure level of the water a water proofing membrane will be installed between outer and inner lining to drain off the mountain water by longitudinal drainage pipes at both side walls.

The 3.600 m long tunnel will be driven conventionally starting from a shaft under the above mentioned B1. The excavation cross-section is subdivided into top heading, bench and invert.

The following lot LT31 is situated in an area with soft ground conditions. Four tracks of the existing connecting line and many residential buildings are to underpass with an overburden from 7 to 25 m. The geological conditions are characterised by clay, sand, gravel and conglomerate.

To reduce the settlements on the surface, the excavation cross-section is subdivided in two separated side drifts and a succeeding center drift (fig. 4). The side drifts are parted in top heading, bench and invert, the center drift will be excavated in two steps – a leading top heading with a bench, connected with a ramp to the carriage way in the tunnel, and a following bench/invert. The inner side walls of the side drifts will be demolished when the outer sprayed concrete lining is already closed to a ring.

Fig. 4: Subdivision of the excavation cross section in lot LT3

Fig. 5: Regular tunnel profile with water-impermeable inner lining

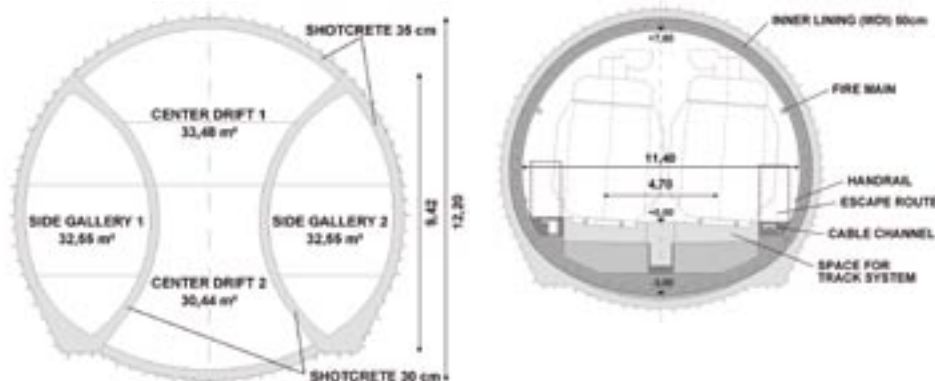

For support an outer lining of reinforced sprayed concrete, steel arches, spiling with rebars and pipes as well as steel laggings are used.

The invert of the outer lining is local strengthened to reduce the possibility of rotation in unfavourable building levels.

In lot LT31 the partly confined tertiary groundwater is temporarily lowered through a great number of wells and some shafts with horizontal drainage borings from the surface. In addition drainage pipes will be set from the excavation face to drain off the remaining groundwater. Because of approximately 20 m water table in final condition the inner lining is designed as a water-impermeable concrete structure (WDI) [3].

To keep the maximum differential settlements at the surface within limits protection measures are designed for buildings directly above the tunnel. Depending on the position of each of these buildings compaction grouting or bored piles will be executed.

### **3.3 Link to Donaulände Railway and connection to Southern railways**

In this section the connection to Donaulände Railway and the grade-free link of the Lainzer Tunnel to the Southern railways takes place by ramps. This measure effects an advancement of the running-in situation at station Meidling.

The key issues of this section are the underpassing of two existing railway lines, subway U6, a main high voltage line (380 kV) and a trolley line – all lines will keep in operation during the construction of the tunnels. In addition the changeover from one double-track to two single track tunnels is to perform directly under he mentioned Donaulände Railway.

Therefore the tunnel has to expand in three parts - up to 180 m<sup>2</sup>. To support the excavation work cement grouting will be necessary to consolidate the present sand and gravel layer.

## **4. Safety facilities - emergency exits**

At the Lainzer Tunnel 27 emergency exits are arranged.

Most of these are a combination of horizontal galleries with a maximum gradient of 10% and vertical shafts; some are made up of just one of these components. Shafts higher than 15 m are equipped with staircases and lifts up to the surface. The lifts will serve relief units to handle their material components and to evacuate injured people in case of an accident. The maximum distances between emergency exits are 599 m; the average emergency route to safe areas is 240 m.

Each emergency exit is protected by a ventilated system which consists of a closed door on either side. When one door is opened, a ventilator fan produces airflow to prevent an infiltration of smoke. The minimum length between the two doors is 12 m – this distance is required to assure the essential air stream across the whole cross section.

For fire fighting tunnel tubes are equipped with a water main for each track which is supplied from every emergency exit. The water mains are placed at the side walls above the walkway (1.2 x 2.2 m) (see also fig. 4). Fire hydrants are located every 50 m, always combined with electric power supply.

SOS-telephones are situated in every emergency exit (before, in and behind locks

and on top of the staircases) as well as in the middle between two exits.

In addition each exit has to accommodate space for 500 people between tunnel and staircase – within the secure area.

### 5. Vibration control

Driving through a tunnel, the train produces dynamic acting forces which are derived from the tracks through the trackworks into the tunnel structure and further on in the underground. By choosing the right construction for the pavement, these different kinds of waves should be transformed so far, they don't have any negative effect to the neighbourhood. For that reason an elastic element is situated between the track slap and the inner lining. With this system the tracks become decoupled from the underground through a so called "mass-spring-system".



Fig. 6 Mass-spring-system (model)

To prevent or at least reduce the transmission of waves to the inner lining, the elasticity of the springs has to be harmonized with the causative dynamic forces. The capacity of a mass-spring-system to damp vibrations is very effective by using a large mass and/or soft spring suspension. For both parameters limits are set, on the one hand the existing space (mass), on the other hand the maximal tolerable settlements for the rails (spring). For that reason it's necessary to optimize this system. To find out the definitive requirements for the final design

tests with artificial vibrations have to be done. Therefore a specialized machine produces vibrations in the tunnel (VibroScan®-Tests<sup>1)</sup>). These are observed in the surrounding build-up area. The results are used to calibrate the dimension of the mass-spring-system.

Table 1: Track work systems in the Lainzer Tunnel

systems for vibration control	areas of application
- ballast-substructure with/without elastic mat underneath	ramp- and portal-sections
- track slap system	tunnel without nearby buildings
- mass-spring-system light / medium / heavy	tunnel with nearby buildings adjusted to tunnel construction / geology

Ensuring the required space for the vibration control system, the tunnel profile has to accommodate at least the next heavier system in the planning phase.

<sup>1)</sup> VibroScan® is a registered trademark of ZAMG (Zentralanstalt für Meteorologie und Geodynamik) in Vienna, Austria.

### 6. Increased fire-resistance of inner linings

Fire catastrophes in Tauern- und Mont Blanc-tunnel in 1999 caused a great deal of public discussion about fire in tunnels. From that time on owners of new infrastructure projects in Austria have to deal with this topic in the design of the tunnel structure.

The second building permits [4, 5] for the Lainzer Tunnel contain specifications which have to be fulfilled by the tunnel design.

The required heat-resistance (duration of fire) depends on the existing kinds of

buildings and infrastructure above the railway tunnel – and the time needed for evacuation.

The soft ground sections of the Lainzer Tunnel (LT22, 31 and 44) are classified in protection level 2 (major structures like residential buildings above the tunnel may be affected). The hard rock section in lot LT33 is defined as protection level 0 (no effect on surface structures). Only for a short sector (a river crossing) protection level 3 (major buildings with difficult evacuation above the tunnel may be affected) is to take into account.

The tunnel structure has to withstand a design fire, developed by experts especially for the Lainzer Tunnel (fig. 7).

Fig. 7 Design fire

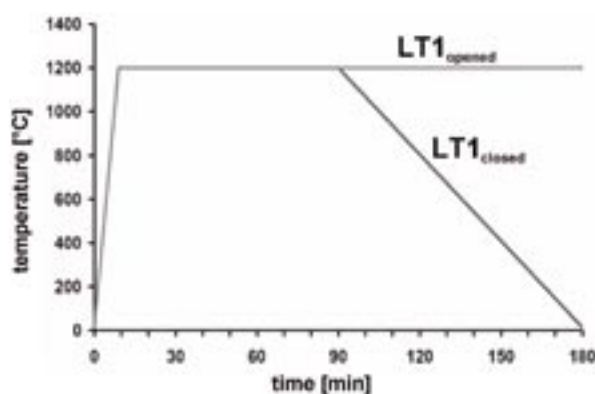

The rapid rising of temperature results in progressive spalling of the concrete. In addition reinforced steel lose strength beyond 150°C. So the inner linings get rid of their supporting function.

A possibility to increase fire protection is the application of fire protection panels or layers of protective material. The disadvantage of protection panels are the great effort for investigations of the concrete structure surface in the future, their unknown long-time durability and their costs. Therefore other solutions were investigated in many testing programs in recent years.

During placing of the inner lining in lot LT22, which is being done from September 2001 till this day, an adequate measure had to be found to increase the fire-resistance of the inner lining structure.

Primary spalling should be prevented by adding a third reinforcement layer. The required static reinforcement got a greater concrete cover (10 cm instead of 5 cm). A third reinforcement layer (AQ°50) with a concrete cover of 5 cm should reduce the spalling depth. A research program [6] carried out parallel could not prove the effectivity of this system.

So the design had to be changed to the two layer reinforcement standard and the application of a 1.5°cm thick fire protection panel. In case of fire the concrete lining is exposed to a reduced temperature. The above mentioned disadvantages of this system had to be accepted because of the progress of construction work.

Meanwhile additional testing programs [6 and 7] showed that adding about 2 kg/m<sup>3</sup> polypropylene-fibres can avoid a spalling of the inner shell concrete reliably

in tunnels even under the extreme condition of a fire. To ensure the main support function of the inner lining the concrete cover must be extended to ca. 8 cm (depending on the design temperature). Adding the fibres it must be taken into account that the fibres change the characteristics of concrete [8, 9 and 10]. The characteristics (mixing, batching, pumping and compaction) for an installation of reinforced inner linings especially are negatively influenced. Therefore extensive lab experiments were necessary to adjust components and additives for the concrete to get an appropriate water-impermeable inner lining. After in-situ tests the concrete has been successfully employed at lot LT22. More than 700 m of inner lining (about 6.300 m<sup>3</sup> PP-fibre-concrete) for the single track tunnel were made.

The results of the mentioned research programs provided a basis for a new Austrian guideline for increased heat-resistant concrete for underground infrastructural facilities [11].

#### 7. Conclusion - Forecast to contract sections in the future

Structural works at the Western Railway Link will be completed in the second quarter 2005.

Then only tunnelling work for the eastern part of the Wienerwaldtunnel will be performed there. When this will be also finished, working for trackworks and installation of electrical and safety equipment and signalling to be done before the Western Railway Link will go into service in 2008.

Tendering procedures for the Connecting Tunnel and the connection to Donaulände Railway will likely start in December 2004 up to autumn 2005.

Until midyear 2010 all structural works should be completed at the whole project, in 2013 the connection from the Western Railway to the South should go into service.

#### References

- [1] Muchsel, Ostermann: Der Lainzer Tunnel – Eine neue Verbindung der West- und Südbahn im Raume Wien, In: Bauingenieur 2002.
- [2] HL-AG, ÖBB, BEG: Richtlinie für das Entwerfen von Bahnanlagen - Hochleistungsstrecken, Vienna, May 2002.
- [3] ÖVBB-Richtlinie Innenschalenbeton; Österreichische Vereinigung für Beton und Bautechnik, Vienna, October 2003
- [4] BMVIT, EB-Bescheid 3. Abschnitt "Verbindungstunnel", Vienna, Sept 2004
- [5] BMVIT, EB-Bescheid 4. Abschnitt "Verknüpfung Westbahn", Vienna, June 2002
- [6] Kusterle, et al: Brandbeständigkeit von Faser-, Stahl- und Spannbeton (Fire resistance of fibre-reinforced, reinforced and pre-stressed concrete). Republik Österreich, Bundesministerium für Verkehr, Innovation und Technologie (Hrsg.), Straßenforschung Heft 544, Österreichische Forschungsgemeinschaft Straße und Verkehr, Vienna, 2004.
- [7] FFF-Projekt Nr. 806201: Praxisverhalten von erhöht brandbeständigem (Innenschalen-)Beton (EBB); Forschungsinstitut der Vereinigung der österreichischen Zementindustrie, gefördert von BEG, HL-AG, ÖBB, ÖVBB, VÖZ, Vienna, 2003.
- [8] Pichler, Wagner: Einflüsse auf die Betoneigenschaften durch den Einsatz von PP-Fasern zur Erhöhung der Brandbeständigkeit von WDI-Innenschalen. In: Beton und Stahlbetonbau 99 (2004), Heft 11.
- [9] Glatzl, Nischer, Steigenberger und Wagner: PP-Faserbeton für Beton erhöhter Brandbeständigkeit. Untersuchungen zur Wirksamkeit und Ermittlung des Polypropylenfasergehalts am Festbeton. In: Zement und Beton, Heft 3/04, Vienna, 2004.
- [10] Rath, Haberland: Herstellung und Einsatz von PP-Faserbeton für wasserdichte Innenschalen. In: Zement und Beton, Heft 3/04, Vienna, 2004.
- [11] ÖVBB-Richtlinie Erhöhter Brandschutz mit Beton für unterirdische Verkehrsbauwerke - Gründruck; Österreichische Vereinigung für Beton und Bautechnik, Vienna 2004.



## Avtocestni priključek v predoru Šentvid na avtocestnem odseku Šentvid - Koseze The Motorway Interchange in the Tunnel Šentvid on the Motorway Section Šentvid - Koseze

Monika Pulko, univ.dipl.inž.grad.  
DARS d.d., Družba za avtoceste v Republiki Sloveniji

### Povzetek

Izgradnja polnega priključka Celovške ceste v Ljubljani na avtocesto Šentvid – Koseze z izvedbo priključka v predoru pomeni strokovni izziv že nekaj let. Pravzaprav nihče ni in ne dvomi, da je polni priključek prometno potreben in upravičen, marsikdo pa je dvomil, da je priključek v predoru tehnično izvedljiv in stroškovno upravičen. V letih izvajanja Nacionalnega programa izgradnje avtocest v Republiki Sloveniji smo se projektantsko in izvedbeno spopadli in rešili marsikateri tehnični problem. Marsikdaj smo prestopili mejo neizvedljivega in stvar izvedli in vse te izkušnje so nam v lanskem letu ponovno dale zagon, da preverimo, ali je izgradnja polnega priključka v predoru prav zares »znanstvena fantastika«, kot so še nedavno nekateri zatrjevali. Ogledali smo si tudi predor Mrazovka v Pragi, ki je skorajda kopija našega predora in skozi katerega od avgusta 2004 poteka promet, in ugotovili – zadeva je bila v tamkajšnjih geološko geomehanskih razmerah izvedljiva. Pri nas smo za ugotovitev geološko geomehanskih razmer v predoru izvedli raziskovalni rov. A tudi pot do tega je bila dolga.

### Summary

The construction of an entire motorway interchange of Celovška cesta in Ljubljana to motorway section Šentvid – Koseze with an execution of an interchange in the tunnel has been an expert challenge for many years. In fact nobody doubts that the entire interchange is necessary and righteous with regard to traffic volumes, but some experts doubt that the interchange in the tunnel is technically realizable and it's costs justified. In the years of execution of the National Motorway Construction Programme in the Republic of Slovenia we have clashed with many projects and construction troubles and we have solved many technical problems. Many times we overstepped the limit of unachievable and last year all this experiences gave us a new impulsion to check again if the construction of an entire interchange in the tunnel is really a "science fiction" like some experts have affirmed not long ago. We have taken a close look at the tunnel Mrazovka in Prague, which is very similar to our tunnel and has been given over to traffic in August 2004. And we have seen that – in their geological conditions - it was possible. In our case we constructed a pilot tunnel to find out what our geological conditions were. But the way to this conclusion was also long.

### 1. Uvod

Avtocestni odsek Šentvid – Koseze je vključen v Nacionalni program izgradnje avtocest kot del avtoceste A 2 Karavanke – Obrežje. Glede na prostorsko utesnjenost lokacije priključka Šentvid in bližino predora, je izvedba polnega priključka vseskozi veljala za velik izziv gradbeniške stroke. Že leta 1996 je bila izdelana Prometna

študija priključevanja odseka AC Šentvid – Koseze na Celovško cesto (PNZ, januar 1996, dodatek julij 1996), ki je vključevala tudi primerjavo variant, vendar je ta študija obravnavala le ožje vplivno območje in ni podala pravih rezultatov za rešitev močnih prometnih tokov s širšega območja. V fazi izdelave preliminarne primerjalne študije Gradbeno-tehnična primerjava ter prometno in ekonomsko vrednotenje različic priključka Šentvid na avtocestnem odseku Šentvid – Koseze (PNZ, junij 1999) je bilo ugotovljeno, da je izgradnja polnega priključka iz gradbeno tehničnih in varnostnih razlogov problematična, zato je bilo odločeno, da se rešitve iščejo z nadgradnjo polovičnega priključka z razbremenilnimi cestami.

Pri predlogu rešitve priključevanja avtoceste na Celovško cesto se je tako odstopilo od rešitve s polnim priključkom in se predlagalo izgradnjo avtoceste s polovičnim priključkom, drugo polovico priključka pa naj bi nadomeščala nova povezovalna cesta Stanežiče – Brod in Jeprca - Povodje.

Po sprejemu Uredbe o lokacijskem načrtu za avtocesto Šentvid - Koseze s polovičnim priključkom (2002) se je pristopilo k iskanju variante poteka navezovalne ceste Stanežiče – Brod. Med zbiranjem strokovnih podlag za pripravo primerjalne študije je MOL podala nova izhodišča o rabi prostora. Ti spremenjeni pogoji (predvidene tri nove soseke: Stanežiče, Tkalnica in Škofovi zavodi) predstavljajo bistveno povečano koncentracijo stanovalcev na ožjem vplivnem področju posledično pa tudi bistveno povečanje pričakovanega obsega prometa.

#### 2. Osnovna izhodišča za iskanje polnega priključka AC Šentvid – Koseze na Celovško cesto

Tako iz razloga novih podatkov o predvideni rabi prostora, velike prometne obremenjenosti Celovške ceste že danes, kot tudi na podlagi mnogih novih izkušenj pri gradnji predorov na avtocestah, ki smo jih pridobili v tem času, je bila v letu 2003 ponovno preverjena možnost izgradnje polnega priključka AC Šentvid – Koseze na Celovško cesto.

Vključenih je bilo pet projektantskih organizacij, ki so se lotile enakega izziva – poiskati rešitev polnega priključka. Rezultat je bilo pet novih in različnih idejnih rešitev, od katerih se je kot prometno najbolj učinkovita izkazala rešitev s točkovnim semaforiziranim nivojskim križiščem na Celovski cesti. Rešitev je med vsemi različicami najboljše omogočala prometno odvisno krmiljenje prometa in zadovoljivo praznjenje predorskih priključkov.

V nadaljevanju so bile preverjene in cenovno ovrednotene rešitve, ki so iz skupne točke na Celovski cesti na različne načine navezale promet na AC Šentvid – Koseze. Ovrednotena je bila cena izgradnje AC predora in priključnih predorov v naslednjih variantah:

VARIANTA	STROŠKI IZGRADNJE PREDORA (v SIT)
Varianta 1: osnovna varianta (2 pasovni predor in polovični priključek)	9.979.900.000
Varianta 2: dva priključevalna predora, polni priključek v predoru in v nadaljevanju 3 pasovni AC predor	16.886.600.000
Varianta 3: 2 pasovni AC predor + 2 vzporedna enosmerna priključna predora po celotni dolžini	18.829.900.000
Varianta 4: 2 pasovni AC predor + 1 vzporeden dvosmeren priključni predor po celotni dolžini	15.041.035.000

Tabela: primerjane variante priključka Šentvid s skupno točko na križišču na Celovski cesti

Kot najcenejša rešitev polnega priključevanja se je res izkazovala rešitev po varianti 4, glede na možnost fazne gradnje pa se je kot aktualna pojavljala tudi varianta 3, vendar je potrebno upoštevati:

- predor za dvosmerni promet je z vidika prometne varnosti manj ustrezen (varianta 4),
- v primeru dodatnega dvosmernega predora (ali dveh enosmernih) je potrebno tudi v priključevalnih predorih po celotni dolžini izvesti odstavne niše,
- potrebno je izvesti prečne povezovalne predore iz priključevalnih predorov v avtocestni predor za intervencijo, kar stroškovno ni ovrednoteno, potrebno pa bi jih bilo vsaj delno zgraditi v prvi fazi,
- tudi priključevalne predore je potrebno opremiti z elektrostrojno opremo,
- vzdrževanje 3 ali 4 predorov je bistveno dražje od vzdrževanja 2 predorskih cevi s priključnima rampama.

V vseh obravnavanih različicah se priključevanje izvede na odprti trasi, zato je povečanje teh stroškov glede na osnovno investicijo s polovičnim priključkom (dodatna zemljišča, gradbeni stroški, daljši objekti, dodatne rušitve,...) primerljivo in kot tako nebitveno pri izbiri najustreznejše variante polnega priključevanja.

Glede na rezultate zgoraj navedenih preveritev je DARS d.d. pristopil k natančnejši analizi in proučevanju variante polnega priključka Šentvid z izvedbo dveh predorskih ramp, priključka v predoru in v nadaljevanju 3 pasovnega AC predora (varianta 2).

### 1. Obseg gradbenega posega

Razlog za spremembo polovičnega priključka Šentvid v polnega so brez dvoma prometni učinki, ki poleg razbremenitve obstoječe cestne mreže pomenijo tudi večjo fleksibilnost omrežja oz. manjšo ranljivost. Dejstvo je, da je možno polni priključek s priključitvijo ramp v predoru zgraditi le istočasno z avtocestnim predorom, saj v primeru izgradnje dvocevne dvopasovne predora kasnejši priključek v predoru ni več izvedljiv.

Spremembe projektne rešitve, ki so posledica umestitve polnega priključka Šentvid, zajemajo naslednje:

- a) polni priključek Šentvid namesto polovičnega, kar pomeni, da se iz smeri Celovške ceste proti jugu doda enopasovna priključna rampa, iz avtoceste iz smeri Kosez oziroma juga proti Celovski cesti pa se odcepi dodatna enopasovna izključna rampa, ki se za odcepom razširi v dvopasovno.

Predvideno je polno semaforizirano križišče na Celovski cesti na mestu obstoječega polovičnega priključka z novima priključnima rampama, ki se bosta južno od križišča zakopali v predor in se nato priključili vsaka na eno avtocestno predorsko cev.

Predorske cevi potekajo v zahtevni permokarbonski hribini, zato je bilo predvideno, da se za natančno določitev lokacije priključitve predorskih cevi – kavern in s tem tudi natančne dolžine in nagiba obeh priključnih predorov počaka do znanih rezultatov iz raziskovalnega rova. Na osnovi predhodnih geoloških podatkov so bile lokacije kavern predvidene od 400 do 500 m v predoru. V kolikor bi predvidene lokacije bile tudi dejanske, bi bila potrebna dolžina raziskovalnega rova okoli 800 m.

V času pisanja tega prispevka (oktober 2004) je skopanih 390 m raziskovalnega rova, katerega rezultati so pokazali, da je približno 200 m pred predvideno lokacijo v

## 7. mednarodno posvetovanje o gradnji predorov in podzemnih prostorov

### TEMA 2 | NAČRTOVANJE KONSTRUKCIJ IN VZDRŽEVANJE PODZEMNIH PROSTOROV

desni cevi avtocestnega predora že mogoče locirati desno – priključno kaverno. Izkop raziskovalnega rova se zdaj vrši v prečniku proti levi cevi, kjer se bo potem nadaljeval do geološko ugodne lokacije še za levo – izključevalno kaverno. Dosedanji rezultati kažejo ugodnejše geološke razmere v hribini, kot so bile predvidene, posledično pa bodo krajši tako sam raziskovalni rov (nova dolžina 590 m), kot tudi priključne predorske rampe, katerih minimalne dolžine so določene s prometno tehničnimi pogoji (maksimalni vzdolžni nagib).

Slika 1. Prečni prerez predorskih cevi (izključevalni predor, dvocevni avtocestni predor in priključevalni predor)

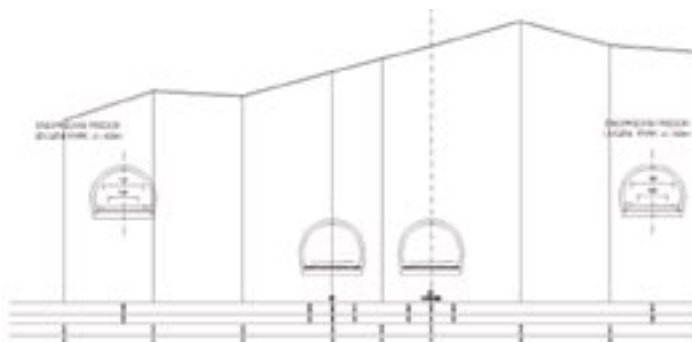

Priključna rampa za smer Celovška cesta – Koseze je predvidena kot enopasovni predorski profil, predvidena dolžina rampe v predoru je 254 m, priključna (izključna) rampa za smer Koseze – Celovška cesta pa poteka v predoru na dolžini 274 m in je na območju odcepa iz tropasovnega predora predvidena kot enopasovni, kasneje pa se zaradi bližine semaforiziranega križišča razširi v dvopasovni predorski profil.

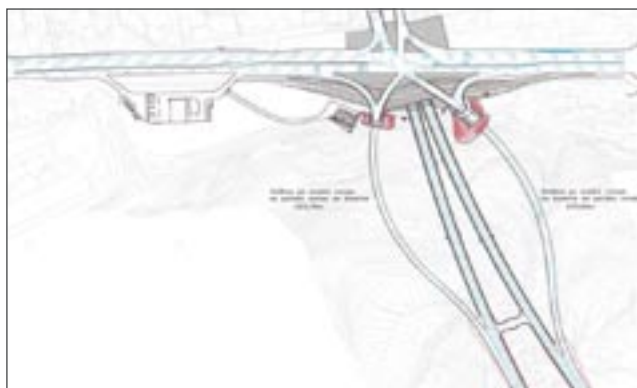

Slika 2. Situacija predora Šentvid in priključka na Celovško cesto.



Slika 3. Situacija predora in priključka Mrazovka v Pragi

Na območju Celovške ceste se zaradi zagotovitve prepustnosti križišča predvideva razširitev za en vozni pas med sosednjima križiščema.

S strani MOL planirana trasa mestne železnice ob Celovški cesti bo lahko potekala ali v sredini Celovške ceste ali izvennivojsko iznad obeh novopredvidenih južnih priključnih ramp.

a) razširitev predora med priključkom Šentvid in južnim portalom iz dveh dvopasovnih predorskih cevi v dve tropasovni cevi,

Predvsem vključevanje v predoru predstavlja šibko točko iz stališča prometne varnosti, zato je namesto klasičnega zaviralnega oz. pospeševalnega pasu predvideno podaljšanje tretjega pasu do južnega portala predora in zaključek dodatnih pasov na oddaljenosti ca 300 m od južnega portala.

Slika 4. Situacija preureditve Celovške ceste zaradi polnega priključevanja.



Slika 5. Prečni prerez predorske kaverne v desni cevi predora Šentvid.

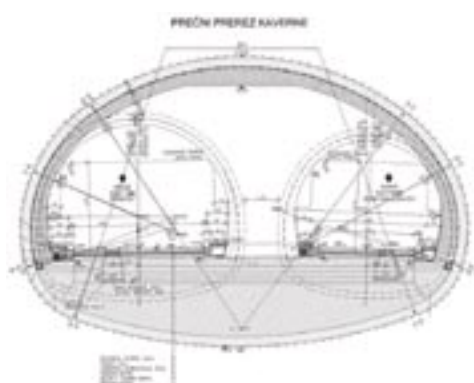

Slika 6. Predorska kaverna v že zgrajenem predoru Mrzavka v Prahi.



Poleg prometno-varnostnega učinka, ki je primaren, bosta v perspektivi dodatna pasova koristna tudi iz stališča prometne prepustnosti. Podobna rešitev z dvocevnim tropasovnim predorom, ki je bila pred nekaj leti iz istih razlogov uporabljena v predoru Golovec na južnem delu ljubljanskega avtocestnega obroča, kaže dobre rezultate.

- a) razširitev 4-pasovne avtoceste med južnim portalom predora Šentvid in koncem odseka pri Kosezah tako, da bo možna kasnejša razširitev v 6-pasovnico brez dodatnih posegov in rušitev avtocestnih objektov,
- b) podaljšanje oz. preureditev objektov, ki prečkajo avtocesto, tako, da bodo ustrezali širini bodoče 6-pasovne avtoceste.

#### 4. Ocena investicije polnega priključka v Šentvidu (nivo cen dec.2002, DDV vključen)

Investicijska vrednost iz Investicijskega programa za odsek avtoceste Šentvid – Koseze upošteva polovični priključek na Celovško cesto, dvopasovni predor Šentvid in 4-pasovno avtocesto do konca odseka. Investicijska vrednost del po Investicijskem programu: 25.499.844.512 SIT

Dodatni stroški na predoru zajemajo izvedbo polnega priključka avtoceste na Celovško cesto, izvedbo dodatnih vstopno/izstopnih klančin, izvedbo kavern, kjer se rampi priključita na predor, izvedbo predora z dodatnim tretjim pasom, razliko v elektrostrojnih instalacijah ter izvedbo raziskovalnega rova.

Prav tako so v oceno vključeni vsi dodatni stroški izgradnje daljših objektov (samo razlika med ceno objektov za 4 pasovnico oz. 6 pasovnico), dodatni stroški v zvezi s polnim priključkom (odkupi, razširitve...), in dodatni stroški izgradnje 3. pasu AC Pržanj - Koseze.

## 7. mednarodno posvetovanje o gradnji predorov in podzemnih prostorov

### TEMA 2 | NAČRTOVANJE KONSTRUKCIJ IN VZDRŽEVANJE PODZEMNIH PROSTOROV

dodatna dela na predoru:	9.543.920.286 SIT
objekti:	147.925.024 SIT
Celovška cesta:	808.469.682 SIT
Razširitev AC Pržanj - Koseze	311.838.306 SIT
skupaj ocena dodatnih stroškov za polni priključek:	10.812.153.299 SIT

Ocena nove investicijske vrednosti je zaradi primerljivosti cen preračunana na nivo cen za december 2002. (upoštevane je kumulativni indeks v letu za sep 03, ki znaša 103,9)  
Nova investicijska vrednost del: 36.311.997.811,00 SIT

#### 5. Ocena okoljske in prostorske sprejemljivosti

- bistvena prednost rešitve s polnim priključkom je prometna razbremenitev Celovške ceste in vzporednic, s tem se zmanjšajo emisije iz prometa, zaradi česar se povečuje kakovost bivalnega okolja vzdolž Celovške oziroma Prušnikove ter Vodnikove ceste kot nosilk urbanega programa;
- predlagane rešitve posegajo v formalizirana območja varstva - Krajinski park Polhograjski dolomiti ter Spomenik padlim v NOB v Šentvidu, vendar bo moč izvesti ustrezne omilitvene oziroma nadomestne ukrepe;
- predlagane rešitve pomenijo poseg v plansko opredeljeno "parkovno, športno in rekreacijsko površino", vendar ocenjujemo, da je moč z ustrezno krajinsko ureditvijo ohraniti pomen tega območja v zaznavi Celovške ceste;

Ocenjeno je bilo, da je rešitev s polnim priključkom na Celovško cesto okoljsko in prostorsko sprejemljiva rešitev, v smislu razbremenitve Celovške ceste in vzporednic pa ustrežnejša rešitev kot rešitev s polovičnim priključkom tudi v okoljsko prostorskem kontekstu.

#### 6. Prometno in prometno-ekonomsko vrednotenje



Obravnavane so bile naslednje različice prometnih omrežij:

	različica				
	1	2	3	4	5
Zgrajeno cestno omrežje					
AC Šentvid - Koseze	da	da	da	da	da
polovični priključek Šentvid	da	da	da		
polni priključek Šentvid				da	da
rekonstruirana cesta Jeprca - Šentvid (4 pasovna cesta)	da	da	da	da	da
rekonstrukcija obvozne ceste (Nemška cesta)	da	da	da	da	da
navezovalna cesta Stanežiče - Brod		da	da		da
nova povezava od obvozne ceste do Ul. Jožeta Jame			da		da
navezovalna cesta Povodje - Jeprca			da		da

Obravnavani so bili štiri časovni preseki in sicer leto 2007, 2015, 2016 in 2027.

- Za leto 2007 in leto 2015 se upošteva etapna rešitev cestnega omrežja (različici 2 in 4) in je primerjana učinkovitost polovičnega priključka Šentvid + Stanežiče - Brod ter polnega priključka Šentvid brez Stanežiče - Brod.
- Za leto 2016 in leto 2027 se upošteva končna rešitev prometnega omrežja (različici 3 in 5), kjer se različice razlikujejo samo glede oblike priključka v Šentvidu.

Slika 7. Različice prometnih omrežij.

Obravnavane so bile prometne obremenitve v treh konicah delovnega dneva (jutranja konica, popoldanska konica in opoldanska – »poslovna« konica).

Pri etapni rešitvi prometnega omrežja (različici 2 in 4), polni priključek pritegne v predor:

- Leto 2007: jutranja konica + 40% prometa (+833 vozil/uro)  
opoldanska konica + 34% prometa (+559 vozil/uro)  
popoldanska konica + 27% prometa (+619 vozil/uro)
- Leto 2015: jutranja konica + 34% prometa (+872 vozil/uro)  
opoldanska konica + 30% prometa (+596 vozil/uro)  
popoldanska konica + 24% prometa (+637 vozil/uro)

Pri končnih rešitvah prometnega omrežja (različici 5 in 3), polni priključek pritegne v predor:

- Leto 2016: jutranja konica + 23% prometa (+675 vozil/uro)  
opoldanska konica + 17% prometa (+347 vozil/uro)  
popoldanska konica + 20% prometa (+563 vozil/uro)
- Leto 2027: jutranja konica + 22% prometa (+717 vozil/uro)  
opoldanska konica + 16% prometa (+374 vozil/uro)  
popoldanska konica + 20% prometa (+620 vozil/uro)

Skupna ugotovitev:

- V predoru je v različnih časovnih presekih in različicah omrežja od 16 do 40% več prometa, kar je prometno in okoljsko ugodno.
- Polni priključek v primerjavi s polovičnim v vseh primerih v predor pritegne več prometa, s čimer se razbremeni Celovška cesta in njene vzporednice. Kapaciteta avtocestnega odseka Šentvid Koseze je bolj izkoriščena.

Prihranki časa na dan pri etapni rešitvi prometnega omrežja (primerjani različici 2 in 4) - prihranki časa v primeru polnega priključka glede na polovičnega s povezovalno cesto znašajo:

Leto 2007:	jutranja konica	140 ur/dan
	opoldanska konica	432 ur/dan
	popoldanska konica	490 ur/dan
	skupaj	1.062 ur/dan
Leto 2015:	utranja konica	105 ur/dan
	opoldanska konica	625 ur/dan
	popoldanska konica	995 ur/dan
	skupaj	1.725 ur/dan

Prihranki časa na dan pri končni rešitvi prometnega omrežja (primerjani različici 3 in 5) - prihranki časa v primeru polnega priključka glede na polovičnega znašajo:

Leto 2016:	jutranja konica	698 ur/dan
	opoldanska konica	917 ur/dan
	skupaj	2.526 ur/dan
Leto 2027:	jutranja konica	498 ur/dan
	opoldanska konica	935 ur/dan
	popoldanska konica	540 ur/dan
	skupaj	1.973 ur/dan

#### Skupna ugotovitev:

- Veliki prihranki že v letu 2007 utemeljujejo potrebo po izgradnji polnega priključka istočasno z izgradnjo AC Šentvid – Koseze.
- Polni priključek v primerjavi s polovičnim v vseh obdobjih in obeh etapah prinaša prometne prihranke. Največ prihrankov prinaša končno omrežje v obdobju od leta 2016 do 2027.
- Padeč prihrankov v letu 2027 je posledica prekoračitve kapacitete na delu omrežja - predvsem na severni obvoznici.

Na podlagi zgornjih ugotovitev je bilo ocenjeno, da je iz prometnega vidika takojšnja izgradnja polnega priključka upravičena in utemeljena.

Izdelana je ekonomska presoja upravičenosti izgradnje polnega priključka v Šentvidu. Uporabljen je programski paket TUBA (Transport User Benefit Appraisal). Uporabljene so prometne matrice, ki so bile dobljene s mikroskopsko simulacijo prometa na območju od Stanežič do Stegen in od Broda do Kosez. V ekonomski analizi so upoštevana omrežja po časovnih prerezih 2007, 2015, 2016 in 2027, upoštewane so prometne razmere v treh časovnih pasovih dneva in sicer:

- jutranja konica,
- opoldanska konica (poslovna konica) in
- popoldanska konica.

V vrednotenju so upoštewane matrice potovanj in matrice potovalnih stroškov. Upoštevano je 38% skupnega letnega prometa. Kot dodatni strošek je v omrežju upoštevana investicija v izgradnjo polnega priključka in od priključka naprej tudi tripasovni predor. Uporabljena je diskontna stopnja 8%. Razmerje med dodatnimi /diskontiranimi/ koristmi investicije in dodatnimi /diskontiranimi/ investicijskimi stroški znaša 1,35. Investicija je dejansko ekonomsko upravičena, saj je količnik koristi in stroškov nad 1. Neto oz. čista sedanja vrednost projekta je 2,68 mrd SIT.

## 5. Zaključek

V letih 1996 in 1999, ko so se preverjale variante polnega priključka avtoceste Šentvid – Koseze na Celovško cesto, je bila izvedba priključka Celovške ceste v predoru ocenjena kot izredno težavna. Prisotni so bili dvomi o izvedljivosti kavern na stičiščih priključnih predorov z avtocestnim predorom v geološko geomehansko izrazito slabem terenu, prisotni so bili dvomi o prometni varnosti pri prepletanju prometnih tokov v predoru in pri nastajanju zastojev v predoru pri izvozu na Celovško cesto, vse skupaj pa je bilo zapečateneno še z dvomom o ekonomski upravičenosti razmeroma visoke investicije z visoko stopnjo tveganja nepredvidenih in dodatnih del pri izvedbi. Odločitev o sprejemu variante avtoceste s polovičnim priključkom in navezovalnimi cestami je bila na podlagi takratnih vedenj in podatkov logična.

Od potrditve te rešitve do pričetka gradnje je minilo nekaj let. In v teh letih so se pojavile novo predvidene soseške, ki bodo velik generator prometa, nabirali smo si izkušnje pri gradnji predorov, znali smo pogledati tudi čez mejo, kaj delajo v tujini in tuji strokovnjaki so pogledali k nam, kaj delamo mi. Povsem logično je torej bilo, da smo se pred pričetkom gradnje predora Šentvid s polovičnim priključkom še



enkrat vprašali – ali resnično poln priključek ni možno zgraditi. Ponovno smo izzvali gradbeniško stroko v Sloveniji in tudi nekatere strokovnjake iz sosednje Avstrije.

Na začetku je bilo še vedno mnogo pomislekov in mnogo dilem. Nekateri so bili optimisti, drugi realisti, tretji pesimisti. A vendar smo prav vsi sodelovali in korak za korakom smo podirali zidove in manjšali ovire. Toliko sodelovanja med strokovnjaki z različnih področij gradbeništva skoraj na nobenem projektu še ni bilo. Prav vsem se lahko zahvalimo za tvorno sodelovanje. Prometno smo poiskali ustrezno rešitev, podatki o geoloških razmerah so bili skopi, a našli smo rešitev, če se geologija ne bi izkazala za slabšo od predvidene, dokazali smo prometno učinkovitost in ekonomsko upravičenost, lahko rečemo – prepričali smo prepričane in neprepričane. Ostal je torej samo še en velik vprašaj – dejanske geološke razmere. In da smo se še s tega vidika prepričali, smo se odločili izvesti raziskovalni rov. Danes, ko je izvedenega 66% dolžine celotnega rova, katerega rezultati so mnogo bolj ugodni od predvidenih, smo strokovno še korak bližje uresničitvi projekta. V teku so še upravni postopki, katerih rezultat pa ne more napovedati niti raziskovalni rov.

### References

- 1) LUZ: Študija variant priključevanja Celovške ceste na avtocesto Šentvid – Koseze. Ljubljana, januar 2000
- 2) Univerza v Ljubljani, FGG PTI: Prometna preveritev polnega priključka v Šentvidu. Ljubljana, maj 2003
- 3) Inženiring IBT Ljubljana: A2 Karavanke – Obrežje, Priključek Šentvid, Idejna rešitev. Ljubljana, julij 2003
- 4) IC consulenten, Elea iC: Tunnel Šentvid, Finite Element Analysis, Tunnel Support Design and Stability Analysis, Cavern. Dunaj, Ljubljana, september 2003
- 5) Elea iC: Tunnel Šentvid, Economic Study Cost Estimation for Proposed 3-lane Tunnel Project in Comparison of the Already Designed 2-lane Tunnel and Other Variants. Ljubljana, oktober 2003
- 6) PNZ, Projekt nizke zgradbe: A2 Predor Karavanke – Obrežje, AC Šentvid – Koseze, Gradivo za novelacijo lokacijskega načrta. Ljubljana, marec 2004
- 7) LUZ: AC Karavanke – Obrežje, odsek Šentvid – Koseze, Predor Šentvid s polnim priključkom na Celovško cesto, Ocena okoljske in prostorske sprejemljivosti. Ljubljana, februar 2004
- 8) PNZ, Projekt nizke zgradbe: Prometno in prometno ekonomsko vrednotenje polnega priključka v Šentvidu, 3. vmesno poročilo. Ljubljana, marec 2004
- 9) PNZ, Projekt nizke zgradbe: Prometno in prometno ekonomsko vrednotenje polnega priključka v Šentvidu, končno poročilo. Ljubljana, maj 2004

## Predor Karavanke | Sanacija predora na območju med km 0+730 in km 0+825

mag. Tomaž Beguš, univ.dipl.inž.geol., Marko Kočevar, univ.dipl.inž.geol., Aleš Grmšek, dipl.inž.grad., Klemen Sotlar, univ.dipl.inž.geol., vsi Geoinženiring d.o.o., Dimičeva 14, 1000 Ljubljana, tel.:01 2345600, faks: 01 2345610, Email: t.begus@geo-inz.si

dr. Mihael Brenčič, univ.dipl.inž.geol., mag. Tomaž Budkovič, univ.dipl.inž.geol., Geološki zavod Slovenije, Ljubljana Dimičeva 14, 1000 Ljubljana

dr. Borut Petkovšek, univ.dipl.inž.geol., Zoran Grubišič, univ.dipl.inž.geol., Rajko Petrica, univ.dipl.inž.geol., Zavod za gradbeništvo Ljubljana, Dimičeva 12, 1000 Ljubljana

Andrej Ločniškar, univ.dipl.inž.geol., DDC Družba za svetovanje in inženiring, Kotnikova 40, Ljubljana

### Povzetek

V članku opisujemo potek sanacijskih del na hidrološko in stabilnostno problematičnem začetnem odseku Karavanškega predora, ki so potekala v letih 2002 in 2003. Opazovanjem in raziskavam so sledila dela izgradnje z osmimi drenažnimi vrtinami in zamenjava talnega oboka predora na dolžini 55 m.

### Abstract

In paper the remediation works in southern part of Karavanke road tunnel is represented where floor heaving occurred and large amount of water overflowed the road. After investigation works construction began in 2002 with drilling of dewatering boreholes and anchoring of tunnel sides and ended in 2003 with construction of new invert arch in length of 55 m.

**Ključne besede:** predor, Karavanški predor, sanacija, geologija, gradbena dela.

### 1. Uvod

Kmalu po zgraditvi predora Karavanke v letu 1991 so se ponekod v predoru pojavile vidne poškodbe na sekundarni oblogi in na cestišču, ki so dosegale tolikšne velikosti, da je bila ogrožena normalna prevoznost predora. Največje poškodbe so bile registrirane med stacionažama 2530 in 2630 m, kjer se je vozišče dvignilo za 14 cm. Vzrok za dvigovanje tal je bila odsotnost talnega oboka na tem delu. V letu 1997-1998 je bila izvedena sanacija poškodb: izdelava talnega oboka ob predhodnem varovanju izkopa z geotehničnimi sidri.

V projektu za sanacijo teh poškodb je omenjena tudi poškodovanost še enega odseka v predoru med stacionažama 770 in 825 metrov od vhoda v predor. Kazala se je že se v razpokanosti sekundarne obloge predora in dvigovanju cestišča. Takrat so bile na tem območju izdelane tudi drenažne vrtine. Od takratne zaznambe je potekala spremljava tega poškodovanega območja, ki je obsegala meritve konvergenc oziroma dvigov cestišča in spremljavo pretokov vode. Največje deformacije na tem odseku so bile na stacionaži 804 m, kjer so bili beleženi dvigi do 7 cm.

Da gre tudi za hidrološko problematičen odsek, se je izkazalo v novembru leta 2000, ko je prišlo zaradi obilnega jesenskega deževja do poplavljanja cestišča. Poplavljanje je kulminiralo na stacionaži 760 metrov.

Za določitev vzrokov poškodb so bile v začetku leta 2001 izvedene geotehnične in hidrogeološke raziskave s preračuni predvidenih deformacij (slika 1). Glavne ugotovitve so bile, da drenažni sistem ni opravljal zadostne funkcije odvajanja vode in da talni obok sicer obstaja, vendar je poškodovan. Tem ugotovitvam je sledila izdelava predvidenih ukrepov sanacije, ki so zbrani v idejnih zasnovah rešitve problemov pojavljanja vode na cestišču in dvigovanja cestišča v predoru Karavanke. Predvidena je bila sanacija z zamenjavo talnega oboka na delu, kjer se cestišče dviguje in s povečanjem števila drenažnih vrtin na delu, kjer se pojavlja voda.

Slika 1: Preračun predvidenih deformacij cestišča na odseku, na katerem je potekala sanacija.

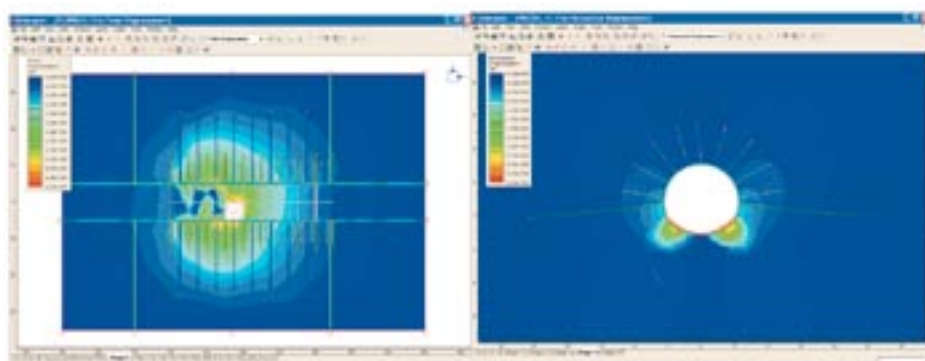

## 2. Položaj in stanje območja obravnavanja

Območje, ki smo ga s projektom obravnavali, se nahaja na oddaljenosti 720 do 825 metrov od južnega portala predora Karavanke. Glede na pojavne oblike problemov sta bili obravnavani dve območji:

- Območje s prevladujočimi hidrogeološkimi problemi med stacionažama 720 in 760 m, kjer nastopata pretežno razpokan apnenec in dolomit ter prelomna cona v meljevcu z bloki dolomita
- Območje deformacij cestišča med stacionažama 770 in 825. Za ta del je po geoloških popisih značilno nastopanje tektonsko zgnetenega glinovca in meljevca z bloki zdrobljenega in razpokanega dolomita.

Prečni prerez obstoječega profila predora je podan na sliki 3 levo. V stopnici je bil na tem delu sicer izveden talni obok, vendar pa na območju, kjer so nastopale samice dolomita, v stopnici lokov ni bilo. Na desni strani predora poteka centralni kanal za odvajanje vode. Maksimalna količina vode, ki teče v odvodnem kanalu, je na tem odseku ocenjena na 140 l/s. V bokih predoru ob cestišču se nahaja tudi več energetskih vodov. Za potrebe dreniranja je bilo na območju s hidrogeološkimi problemi izdelanih več drenažnih niš, iz katerih so bile vrtane drenažne vrtine. Iz njih se voda izteka v bočne drenaže in nato v centralni drenažni sistem.

## 3. Sanacijska dela

Sanacijska dela so bila usmerjena v reševanje pojavne oblike in vzrokov nastopanja neugodnih dejavnikov. Tako smo reševali območje preobilne vode z dodatnimi drenažnimi vrtinami, dvigovanje cestišča pa z zamenjavo najprej enega in nato še drugega dela talnega oboka po segmentih. Z delom le na eni polovici cestišča smo omogočili normalno prevoznost polovice predora.

### 3. Sanacijska dela

#### 3.1. Reševanje hidrogeoloških problemov

Prva faza sanacije je bila usmerjena predvsem v reševanje hidrogeoloških problemov. V ta namen sta bili izdelani dve novi drenažni niši na vzhodu niša št. 6 in na zahodu niša št. 7. Iz teh dveh niš je bilo izvrtanih 8 drenažnih vrtin, po štiri na vsako nišo.

##### 3.1.1. Izdelava drenažnih niš

Izvedli sta bili se dve drenažni niši v bokih predora dolžine 2 m, višine 2 m in širine 1,2 metra. Izvedeni sta bili na kontaktu dveh kampad. Izvedba je potekala v naslednjih fazah: izkop, betoniranje talne plošče, postavitve hidroizolacije, utrditev z brizganim betonom 5 cm debeline, postavitve armatur in betoniranje zgornjega dela ter odstranitev betonskega robu, ki ostane po betoniranju. Za zagotovitev vodotesnosti delovnega stika se je po izvedbi niše uporabil tesnilni trak.

Foto 1: Vrtanje drenažnih vrtin v niši št. 6 na vzhodni strani predora (levo), detajl niše po betoniranju – pogled od zgoraj (desno).



##### 3.1.2. Izvedba drenažnih vrtin

Drenažne vrtine se je izvajalo tipsko. Skupna dolžina drenažne vrtine je znašala 20 - 21 m. Dejanske dolžine vrtin so se določale na podlagi stalne hidrogeološke spremljave na mestu samem. Vrtine so bile od vertikalne navzgor odklonjene med 20° in 36° v smeri pravokotno na os predora.

Slika 2: Situacija odseka, kjer so potekala sanacijska dela.

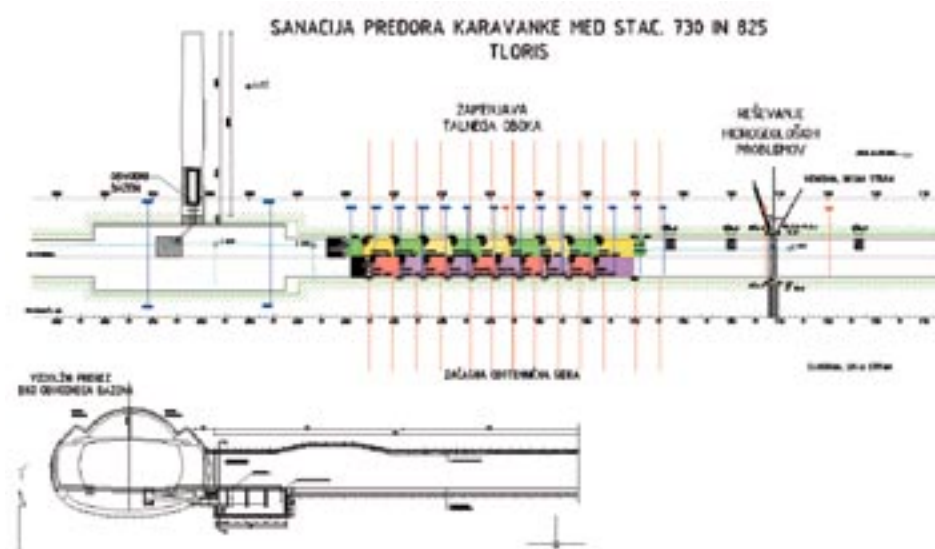

### 3.2. Zamenjava talnega oboka

Problem dvigovanja cestišča smo reševali z zamenjavo talnega oboka. Ta je 0,42 m globlje od starega talnega oboka. S to spremembo znaša minimalna debelina talnega oboka na mestu pod glavno drenažo in cevmi za pitno vodo približno 0,85 m. Talni obok se je zamenjal najprej v celotni dolžini na zahodni strani, nato pa na vzhodni strani predora (Slika 2).

Slika 3: Prečni prerez predora pred (levo) in po (desno) sanaciji.

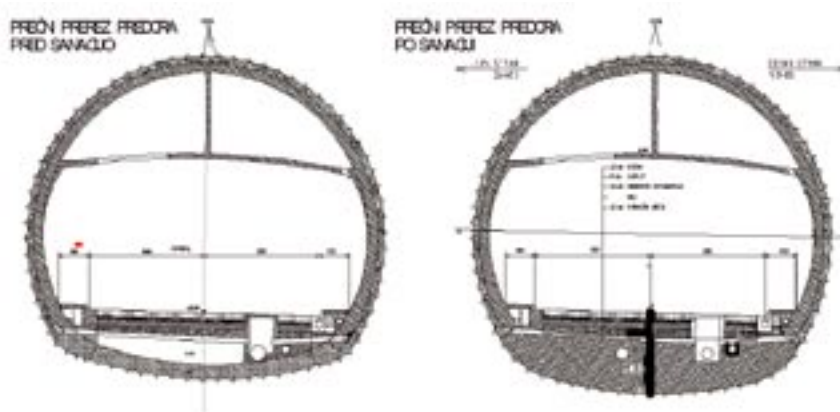

Pri tem se je pojavilo vprašanje kako regulirati velike količine vode, ki je pritekla po glavnem kanalu. Odločili smo se za naslednji redosled del:

- najprej se je zamenjal talni obok v levem, vzhodnem, delu predora. V vsak posamezni segment se je vgradila plastična cev premera 400 mm na točno določenem položaju
- po končanih delih na levem delu sta se na desnem delu izdelala dva jaška, na začetku in koncu odseka zamenjave, v katera smo lahko preusmerili vodo iz glavnega kanala v desni del
- med izdelavo teh dveh jaškov se je vodo preusmerilo v obvodni bazen, iz katerega se vodo črpalo po ceveh v nižjeležeč del predora izven območja sanacije
- po izdelavi teh dveh jaškov se je vodo preusmerilo v obvod, po katerem je voda tekla ves čas zamenjave talnega oboka na vzhodni strani.

#### 3.2.1. Obvodni bazen

V času izdelave revizijskih jaškov za obvod se je vršilo prečrpavanje vode. Prostornina črpališča je znašala 20 m<sup>3</sup>, kar je zadoščalo za čas akumulacije 90 sek, kar je čas za intervencijo pri morebitnem izpadu električnega toka ali zagon dodatne črpalke. Zunanje mere bazena so 740 x 240 x 290 cm, debeline sten so 20 cm. Razpore dajejo objektu večjo varnost in služijo tudi za dostop na objekt na ta način, da se preko njiju položijo leseni plohi ustrezne dimenzije.

Sten gradbenih jam zaradi kompaktnosti hribine ni bilo potrebno razpirati. Preusmeritev vode se je zagotovila z začasno zaporo vode v revizijskem jašku. Iztok iz jaška do črpališča je bil izveden s kanalizacijsko cevjo premera 40 cm.

Črpalke, ki smo jih uporabili za obvodna črpanja, so tip FLYGT tip BS 2151 20kW kapacitete 80-90 l/s. Dve sta v bili obratovanju, ena je bila rezerva.

#### 3.2.2. Začasna geotehnična sidra

Za zmanjšanje premikov notranje obloge med samim odprtjem talnega oboka je bilo potrebno dodatno podpiranje notranje obloge. V ta namen je bilo na območju med stacionažama 765,5 in 825,5 vgrajenih 26 geotehničnih sider v obeh bokih predora, 1,0 m nad cesto. Sidra so oddaljena 5,0 m narazen. Dolžina sider je 20,0 m, prosti del ima 10,0 m, vezni del 10,0 m. Nosilnost sider je 1000 kN. Sila zaklinjenja je 750 kN. Štiri sidra so bila opremljena z dinamometri za merjenje časovnega razvoja sidrne sile na sidrni glavi. Za sidrne glave je potrebno izvesti primerna ležišča. Sestavljale so jih jeklene plošče na podlagi iz malte.

Po končanih delih smo geotehnična sidra razklinili in odstranili del izven predorske obloge. Odprtine je bilo potrebno zatesniti in urediti. Tesnila so se z injektiranjem, tam pa, kjer so bili dotoki vode preveliki, pa se je vgradilo cevko in vodo speljalo v drenažo.

#### 3.2.3. Prevezava energetskih in komunikacijskih vodov

Pred pričetkom del je bila potrebna prevezava energetskih in komunikacijskih vodov ter cevi vode Julijane. Zaradi kompleksnosti in specifičnosti problematike je bila ta ureditev obdelana v štirih posebnih izvedbenih projektih.

#### 3.2.4. Zamenjava talnega oboka

Najprej je bila zaprta vzhodna, desna, stran predora tako je bila lahko izvedena prevezava telekomunikacijskih kablov, hidrantne vode in cevi Julijane. Redosled del je prikazan na sliki 4 na naslednji strani. Dela zamenjave talnega oboka so nato potekala najprej na zahodni, levi, strani vozišča. Zgornje plasti vozišča so bile odstranjene na dolžini 60 m do globine -1,3 m. Sledilo je izkopavanje, opaženje in betoniranje kampad dolžine 5 m v različnem vrstnem redu. Dolžino odsekov smo določili računsko. V talnem oboku je bila vgrajena cev premera 400 mm za obvod. Stik med betonom in tlemi oziroma bokom desne, vzhodne polovice je bil izveden s filcem.

Strižni stik smo dosegli z betoniranjem dveh negativiv 10 x 20 cm na sredini cestišča. Med izvedbo so nastopile težave z dobavo predpisanega sulfatno odpornega cementa. Zaradi tega je med izkopom 9. kampade in njeno betonažo poteklo tri dni, kar se jasno pokazalo na merjenih konvergencah na tem delu. Po končanem betoniranju so bili na betoniran del navoženi armiranobetonski L elementi dolžine 2 m višine 70 cm. Začasno cestišče se je izvedlo z nasutjem bitodrobirja in asfaltom 5 cm debeline. Dne 21.10.2003 je bila voda preusmerjena v obvodni bazen in izvedeno je bilo prečrpavanje, tako, da so bili lahko izvedeni obvodni jaški na začetku in koncu odseka, t.j. na stac. 833 in 769. m in voda preusmerjena v obvod na zahodni strani (foto 2). Odseki zamenjave so bili glede na merjene konvergenca na tem delu daljši, od 5,0 do 7,8 m. Pri tem se je puščala kineta za vod Julijane in požarno vodo. Po končani zamenjavi se je cevovode vrnilo v prvotni položaj in jih obbetoniralo. Geotehnična sidra na tem delu so bila porezana. Sledilo je vgrajevanje vozniških plasti. Geotehnična sidra so bila nato odstranjena še na drugi strani.

Foto 2: Obvodni kanal: vtok (levo) in zasun pred vtokom v glavni kanal (desno)



Slika 4: Faze izvedbe zamenjave talnega oboka.



Foto 3: Izkop segmenta št. 4 na zahodni strani: lepo vidna stratifikacija tehničnih plasti; spodaj še viden talni obok (levo). Postavitev glavnega kanala z revizijskim jaškom v segmentu št. 16 na vzhodni strani (desno).



#### 3.3. Zaključna dela

Ob zaključku del je bilo potrebno območje gradbišča vzpostaviti v prvotno stanje in ponovno urediti prometno signalizacijo (talne označbe, odsevniki, smerniki). Odstraniti je bilo potrebno vso opremo in komunalne vode urediti v prvotno stanje. Očistiti je bilo potrebno kanalizacijski sistem in elektrostrojno opremo.

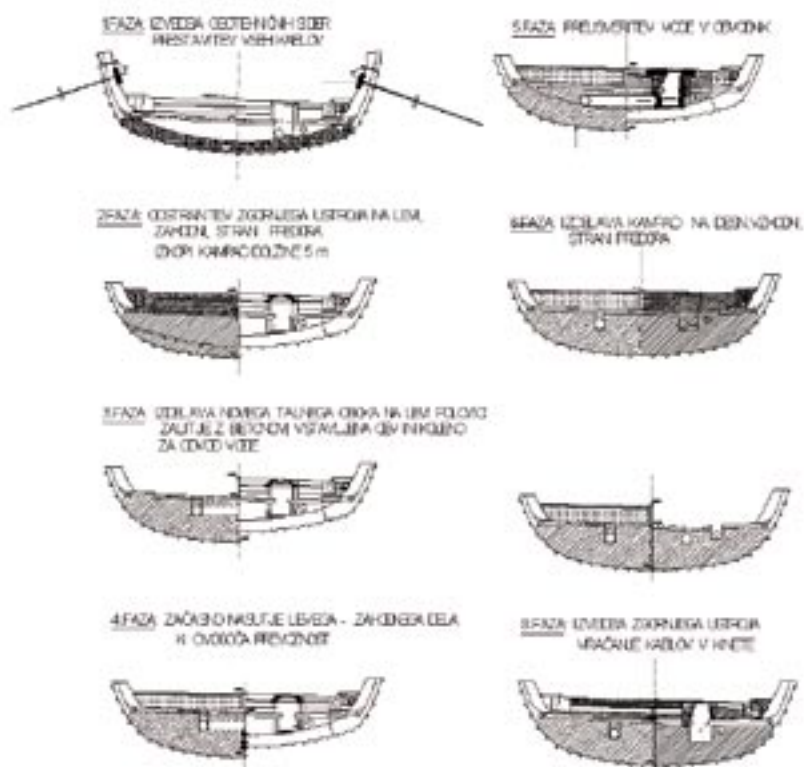
#### 4. Monitoring

##### Monitoring med izvedbo del je obsegal:

- geološko spremljavo izkopnih del in spremljavo vrtnja nekaterih sidrnih vrtin. Kamnine saniranega dela pripadajo spodnjetrojskim kamninam: rdeč in zelen meljevec, siva bela in rožnata sadra, rdečkast dolomit in tankoplastovit dolomit. Odsek leži v prečno dinarski subvertikalni tektonski coni. Največji dvig cestišča poteka na območju sadre in anhidritia, ki zaradi vlage nabreka. Nad to lečo ni bilo talnega oboka, ampak samo nasuta predorska izkopnina.
- geomehanski monitoring 16 merilnih profilov za merjenje konvergenč, meritve na merilnih sidrih in meritve dilatacije na nekaterih merskih mestih. V času izvajanja napenjanja sider so nastale divergencne reda velikosti nekaj desetink milimetra do največ 1,5 mm. Ko smo pričeli z zamenjavo talnega oboka, smo beležili konvergenč, največje do 14,3 mm, predvsem zaradi daljšega časa nepodprtja. Na tem segmentu so bile tudi največje hitrosti: 2,5 mm/dan. Na sidrih smo beležili dvig sile na glavi sidra z 720 na 800 kN. Meritve dilatacij na nekaterih razpokah v predoru so sledile fazam sanacije, vendar niso presegle vrednosti 1 mm.
- hidrogeološka spremljava je obsegala sprotne meritve kvalitete in kvantitete vode med vrtnjem drenažnih vrtin in med izdelavo drenažnih niš.

#### 4. Sklep

Rezultati po zaključku del kažejo, da je sanacija na delu poškodb in problemov z vodo te težave zadovoljivo rešila. Drenažne vrtine so povečale pretok vode tako, da ni zamakanja cestišča. Dvigovanje cestišča se je ustavilo. Pridobili smo pomembne izkušnje za delo na nadaljnjih problematičnih odsekih ali pa podobnih težavah v drugih predorih.